

**1.1.3: Course Syllabus of Employability/
Entrepreneurship/ Skill development**

Academic Year

2021-22



FORM
ISO 9001: 2008
School of Computer Science & Engineering

Syllabus copies of the courses highlighting the focus on employability/ entrepreneurship/ skill development

Program: Bachelor of Engineering		
Course Title: Computer Organization and Architecture		Course Code: 20ECSC201
L-T-P: 3-0-1	Credits: 4	Contact Hrs: 5hrs/week
ISA Marks: 50	ESA Marks: 50	Total Marks: 100
Teaching Hrs: 50	Exam Duration: 3 hrs	

Unit –I		
1	Basic Concepts and Computer Evolution, Performance Issues, A Top-Level View of Computer Function and Interconnection	05 hrs
2	Memory, Input/Output, Computer Arithmetic, Digital Logic	08 hrs
3	Instruction Sets: Characteristics and Functions, Addressing Modes and Formats	07 hrs
Unit –II		
4	Processor Structure and Function, Reduced Instruction Set Computers	10 hrs
5	Instruction-Level Parallelism and Superscalar Processors, Parallel Processing	10 hrs
Unit –III		
6	Multicore Computers, General-Purpose Graphic Processing Units	05 hrs
7	Control Unit Operation, Microprogrammed Control, Case studies and Projects	05 hrs
Text Books:		
1. William Stallings, Computer Organization and Architecture Designing for Performance, 10 th Ed, Pearson Education, 2016.		
Reference Books:		
1. John L. Hennessy and David A. Patterson, Computer Architecture: A Quantitative Approach 5th Edition, Elsevier publication, 2017.		
2. Kai Hwang, Advanced Computer Architecture Parallelism Scalability Programmability, Tata McGraw Hill 2008		

Program: Bachelor of Engineering		
Course Title: Computer Organization and Architecture Lab		Course Code: 20ECSP202
L-T-P: 0-0-1.5	Credits: 1.5	Contact Hrs: 3hrs/week
ISA Marks: 80	ESA Marks: 20	Total Marks: 100
Teaching Hrs: 36	Exam Duration: 3 hrs	

List of experiments



FORM
ISO 9001: 2008
School of Computer Science & Engineering

Syllabus copies of the courses highlighting the focus on employability/ entrepreneurship/ skill development

Week No	Lab Assignments
1	Logisim Tool Demo
2	Combinational Circuits (Half Adder, Full Adder, Decoder, Multiplexer)
3	
4	Building ALU
5	1-bit RAM Cell and building bigger RAM
6	Cache Memory
7	[Cache Simulator + Time Analysis]
8	Instruction Format & Decoding, Control Signal Generation
9	Data Path Design for Given Set of Instructions
10	
11	MIPS 5-Stage Pipeline: Simulates the pipeline.
12	Loop unrolling: A software technique for exploiting instruction-level parallelism.
13	
14	Technical Paper reading, summarizing / Paper Presenting

Scheme for Semester End Examination (ESA)

UNIT	8 Questions to be set of 20 Marks Each	Chapter Numbers	Instructions
I	Q.No.-1, Q.No.-2, Q.No.-3	1,2,3	Solve Any 2
II	Q.No.-4, Q.No.-5	4,5	Solve Any 2
III	Q.No.-6	6	Solve Any 1
	Q.No.-7	7	



FORM
ISO 9001: 2008
School of Computer Science & Engineering

Syllabus copies of the courses highlighting the focus on employability/ entrepreneurship/ skill development

Program: Bachelor of Engineering		
Course Title: Data Structures and Algorithms		Course Code: 20ECSC205
L-T-P: 4-0-0	Credits: 4	Contact Hrs: 4 hrs/week
ISA Marks: 50	ESA Marks: 50	Total Marks: 100
Teaching Hrs: 50hrs	Exam Duration: 3hrs	

Unit –I		
1	Fundamentals of Algorithms and Problem Solving Space and Time Complexities, Order of an algorithm, Efficiency Analysis of Stacks and Queues Revisited, Recursive Definitions, Recursive Functions, Towers of Hanoi, Backtracking, Recursion Vs. Iteration	8 hrs
2	Hashing and Hash tables Direct Address Table, Hash Table, Hash Functions, Collision Resolution Techniques.	4 hrs
3	Graphs and Trees Graphs, Computer Representation of Graphs, Trees, Tree Traversals, AVL Trees, 2-3 Trees, Application of Binary Trees, Tries, DFS, BFS	8 hrs
Unit –II		
4	Sorting Techniques Sorting, Bubble sort, Selection Sort, Insertion Sort, Merge Sort, Quick Sort, Heap Sort.	8 hrs
5	Substring Search Algorithms Brute-force method, Boyer-Moore Algorithm, Knuth-Morris-Pratt Algorithm, Rabin-Karp Algorithm	4 hrs
6	Graph Algorithms Union-Find Data Structure, Shortest Path algorithms, Minimum Spanning Tree Algorithms	8 hrs
Unit –III		
7	Problem Case Studies Travelling Sales Person Problem, Knapsack Problem, Fake Coin Problem, Strassen's Matrix Multiplication, Huffman Coding	5hrs
8	Limitation of Algorithm Power Undecidability, P and NP Classes, P vs NP, NP-Hard, NP-Complete	5 hrs
Text Books:		
1. Thomas H. Cormen, Charles E. Leiserson, Ronald L. Rivest, and Clifford Stein, Introduction to Algorithms, Third Edition, The MIT Press, 2009.		
2. Anany V. Levitin, Introduction to the Design and Analysis of Algorithms. Addison-Wesley Longman Publishing Co, 2012.		
Reference Books:		
1. Hemant Jain, Problem Solving Using Data and Algorithms Using C, Taran Technologies Private Limited, 2016.		
2. HackerRank / CodeChef / SPOJ		

Scheme for Semester End Examination (SEE)

UNIT	8 Questions to be set of 20 Marks Each	Chapter Numbers	Instructions
I	Q.No.-1, Q.No.-2, Q.No.-3	1, 2,3	Solve Any 2
II	Q.No.-4, Q.No.-5, Q.No.-6	4,5,6	Solve Any 2
III	Q.No.-7	7	Solve Any 1
	Q.No.-8	8	



Syllabus copies of the courses highlighting the focus on employability/ entrepreneurship/ skill development

Program: Bachelor of Engineering		
Course Title: Database Management System		Course Code: 15ECSC208
L-T-P: 4-0-0	Credits: 4	Contact Hrs: 4 hrs/week
ISA Marks: 50	ESA Marks: 50	Total Marks: 100
Teaching Hrs: 50	Exam Duration: 3 hrs	

Unit –I		
1	Introduction and ER Model Introduction to DBMS; Data Models, Schemas and Instances; Three-Schema Architecture; Database Languages; Using High-Level Conceptual Data Models for Database Design; An Example Database Application; Entity Types, Entity Sets, Attributes and Keys, Relationship Types, Relationship Sets. Roles and Structural Constraints; Weak Entity Types; Refining the ER Design; ER Diagrams , Naming Conventions and Design Issues.	06hrs
2	Relational Data Model and Relational Algebra Relational Model Concepts; Relational Model Constraints and Relational Database Schemas; Update Operations and dealing with constraint violations; Unary Relational Operations: SELECT and PROJECT; Binary Relational Operations: CARTESIAN PRODUCT, JOIN: Additional Relational Operations; Relational Database Design Using ER- to-Relational Mapping.	08hrs
3	SQL SQL Data Definition and Data Types; Specifying basic constraints in SQL; Schema change statements in SQL; Basic queries in SQL; JOIN operations, Complex SQL Queries .	06hrs
Unit –II		
4	Database Design Informal Design Guidelines for Relation Schemas ; Functional Dependencies; Normal Forms Based on Primary Keys; Boyce-Codd Normal Form.	07 hrs
5	Introduction to Transaction Processing Introduction to Transaction Processing; Transactions and System concepts; Desirable Properties of Transactions; Characterizing Schedules Based on- Recoverability, Serializability.	07 hrs
6	Concurrency Control Techniques Introduction, Two-phase Locking Techniques for Concurrency Control, Dealing with Dead-lock and Starvation, Concurrency control based on Time stamp Ordering.	06 hrs
Unit –III		
7	Database Security Introduction to DB Security Issues, Discretionary Access Control, Mandatory Access Control And Role-Based Access Control, SQL Injections, SQL Attacks;	05 hrs
8	Introduction to NOSQL and Columnar database: Introduction; Difference between SQL and NoSQL; Scaling of Databases; Applications; Columnar Database: Introduction; Row-oriented Systems; Column-oriented systems; Benefits; An Example of Columnar Database;	05 hrs
Text Books:		
<ol style="list-style-type: none"> 1. Elmasri R. and Navathe S., Fundamentals Database Systems, 6th Ed, Pearson Education, 2011. 2. ShashankTiwari , Professional NOSQL, 1st Ed, Wrox, 2011. 		
References:		
<ol style="list-style-type: none"> 1. Ramakrishnan S. and Gehrke J., Database Management Systems, 3rd Ed, McGraw Hill, 2007. 2. Silberschatz A., Korth H.F. and Sudharshan S., Database System Concepts, 5th Ed, Mc- GrawHill, 2006. 		



FORM
ISO 9001: 2008
School of Computer Science & Engineering

Syllabus copies of the courses highlighting the focus on employability/ entrepreneurship/ skill development

Scheme for Semester End Examination (ESA)

UN IT	8 Questions to be set of 20 Marks Each	Chapter Numbers	Instructions
I	Q.No.-1, Q.No.-2, Q.No.-3	1, 2,3	Solve Any 2
II	Q.No.-4, Q.No.-5, Q.No.-6	4,5,6	Solve Any 2
III	Q.No.-7	7	Solve Any 1
	Q.No.-8	8	

Course Title: Data Structure and Algorithms Lab		Course Code: 19ECSP201
L-T-P: 0-0-2	Credits: 2	Contact Hrs: 4 hrs/week
ISA Marks: 80	ESA Marks: 20	Total Marks: 100
Teaching Hrs: 56 hrs	Exam Duration: 3 hrs	

Tentative plan of lab Implementation

Week No	Lab Assignments
1	03 Programming Assignments on Stacks, Queues, Lists, Files
2	
3	
4	01 Assignment on Fundamentals of Algorithms
5	01 Assignment on Trees
6	02 Assignments on Graphs
7	
8	01 Assignment on Sorting
9	01 Assignment on Searching
10	01 Assignment on Sorting and Searching Applications
11	03 Assignments on Graph algorithms
12	
13	
14	Open Ended Experiment

Text Books:

1. Thomas H. Cormen, Charles E. Leiserson, Ronald L. Rivest, and Clifford Stein, Introduction to Algorithms, Third Edition, The MIT Press, 2009.
2. Anany V. Levitin, Introduction to the Design and Analysis of Algorithms. Addison-Wesley Longman Publishing Co, 2012.

Reference Books:

1. Hemant Jain, Problem Solving Using Data and Algorithms Using C, Taran Technologies Private Limited, 2016.
2. HackerRank / CodeChef / SPOJ

Course Title: Computer Organization and Architecture Lab		Course Code: 20ECSP202
L-T-P: 0-0-1.5	Credits: 2	Contact Hrs: 4 hrs/week
ISA Marks: 80	ESA Marks: 20	Total Marks: 100
Teaching Hrs: 56 hrs	Exam Duration: 3 hrs	

Tentative plan of lab Implementation



FORM
ISO 9001: 2008
School of Computer Science & Engineering

Syllabus copies of the courses highlighting the focus on employability/ entrepreneurship/ skill development

Week No	Lab Assignments
1	Logisim Tool Demo
2	Combinational Circuits (Half Adder, Full Adder, Decoder, Multiplexer)
3	
4	Building ALU
5	1-bit RAM Cell and building bigger RAM
6	Cache Memory
7	[Cache Simulator + Time Analysis]
8	Instruction Format & Decoding, Control Signal Generation
9	Data Path Design for Given Set of Instructions
10	
11	MIPS 5-Stage Pipeline: Simulates the pipeline.
12	Loop unrolling: A software technique for exploiting instruction-level parallelism.
13	
14	Technical Paper reading, summarizing / Paper Presenting

Text Books:

1. William Stallings, Computer Organization and Architecture Designing for Performance, 10th Ed, Pearson Education, 2016.

Reference Books:

1. John L. Hennessy and David A. Patterson, Computer Architecture: A Quantitative Approach 5th Edition, Elsevier publication, 2017.
2. Kai Hwang, Advanced Computer Architecture Parallelism Scalability Programmability, Tata McGraw Hill 2008



Syllabus copies of the courses highlighting the focus on employability/ entrepreneurship/ skill development

Program: Bachelor of Engineering		
Course Title: Database Applications Lab		Course Code: 15ECSP204
L-T-P: 0-0-1.5	Credits: 1.5	Contact Hrs: 3 hrs/week
ISA Marks: 80	ESA Marks: 20	Total Marks: 100
Teaching Hrs: 36	Exam Duration: 3 hrs	

List of experiments/jobs planned to meet the requirements of the course.

4- Demonstration	<ul style="list-style-type: none"> ● Introduction to RDBMS/Case study/ basic SQL commands. ● Set theory, logical operators and aggregate functions. ● Group by , Having clause, Views and index ● Basics of PL/SQL.
5-Exercises	<ul style="list-style-type: none"> ● SQL queries on set theory, logical operators and join operations. ● SQL queries queries on aggregate functions, group by and having clause. ● SQL queries on Views and nested query operations. ● PL/SQL queries using triggers and cursors. ● PL/SQL queries using procedures and functions.
3-Structured Enquiry	<ul style="list-style-type: none"> ● Database Design
1-Open Ended Experiment	<ul style="list-style-type: none"> ● Database design & implementation
Text Book:	
i) Elmasri R. and Navathe S., Fundamentals Database Systems, 7 th edition, Pearson Education, 2012.	
ii) Steven Feuerstein, Bill Pribyl Oracle PL/SQL Programming, 6th Edition , O'Reilly Media,2014.	
References:	
1. Ramakrishnan S. and Gehrke J., Database Management Systems, 3 rd edition, McGraw Hill, 2007.	
2. PL/SQL User's Guide and Reference 10g Release 1 (10.1) December 2003.	

Evaluation:

Students Assessment through ISA (80%) + ESA (20%)

Internal Semester Assessment (80%)	Assessment	Weightage in Marks
		Exercises
	Structured Enquiry	20
	Open Ended Experiment	10
End Semester Assessment (20%)	ESA	20
	Total	100



Syllabus copies of the courses highlighting the focus on employability/ entrepreneurship/ skill development

Course Title: Applied Statistics with R		Course Code: 20EMAB209
L-T-P: 3-1-0	Credits: 4	Contact Hrs: 4 hrs/week
ISA Marks: 50	ESA Marks: 50	Total Marks: 100
Teaching Hrs: 40 hrs	Exam Duration: 3 hrs	

Unit I
<p>Chapter 1: Description of data 8 hours Introduction: Data, Type of Variables, mean, weighted mean, median, mode, Quartiles, Variance, Coefficient of variation, skewness, Histogram, Box plots, Normal Quantile Qunatile plots.</p> <p>Chapter 2:Probability 6 hours Introduction: Definition, Interpretation of probability value, addition rule, multiplication rule, Baye’s rule, Applications: Data Classification Methods - Decision Tree Induction, Bayesian Classification.</p> <p>R-tutorial: Introduction to Data handling ,Description of data graphically, Histogram, Skewness, Boxplot, QQ-norm, Decision tree 8 hours</p>
Unit II
<p>Chapter 3: Random variables and Probability Distribution 8 hours Random variables,simple Examples, Discrete and continuous random variables; Introduction to bivariate distribution, joint probability distribution, marginal distribution, covariance. Theoretical distributions: Binomial, Poisson, Normal.</p> <p>Chapter 4: Statistical Inference I 8 hours Introduction: Sampling, SRSWR, SRSWOR, Cluster Sampling, Stratified Sampling, Basic terminologies of testing hypothesis, Confidence interval, Sample size determination, Hypothesis test for proportions, means(single and differences), using P-value approach</p> <p>R-tutorial: Probability distribution, Testing of Hypothesis for proportions, means(single and differences) 8 hours</p>
Unit III
<p>Chapter 5: Correlation and Regression5 hours Meaning of correlation and regression, coefficient of correlation, Linear regression (ANOVA approach), Multiple linear regression, Logistic Regression.</p> <p>Chapter6: : Statistical Inference II 5 hours Test for independence of attributes (m x n contingency table) Inference based on choice of suitable test procedure(Goodness of fit)</p> <p>R-tutorial: Linear Regression with ANOVA approach, Multiple Regression with ANOVA approach 4 hours</p>
<p>Text Books</p> <ol style="list-style-type: none"> 1. J. Susan Milton, Jesse C. Arnold, Introduction to Probability and Statistics: Principles and Applications for Engineering and the Computing Sciences, 4th Ed, TATA McGraw-Hill Edition 2007. 2. Kishor S Trivedi, probability and statistics with reliability queuing and computer science applications, 1ed, PHI, 2000.
<p>Reference Books:</p> <ol style="list-style-type: none"> 1. Gupta S C and Kapoor V K, Fundamentals of Mathematical Statistics, 1ed, Sultan Chand & Sons, New Delhi, 2000. 2. Jiawei Han, Micheline Kamber, Data Mining: Concepts and Techniques, Morgan Kaufmann Publishers, 2005 3. Sheldon M.Ross ,Introduction to Probability and Statistics for Engineers and Scientists



Syllabus copies of the courses highlighting the focus on employability/ entrepreneurship/ skill development

Scheme for Semester End Examination (ESA)

UNIT	8 Questions to be set of 20 Marks Each	Chapter numbers	Instructions
I	Q.No.-1, Q.No.-2, Q.No.-3	1, 2,3	Solve Any 2 out of 3
II	Q.No.-4, Q.No.-5, Q.No.-6	4, 5	Solve Any 2 out of 3
III	Q.No.-7	6	Solve Any 1 out of 2
	Q.No.-8	7	



Syllabus copies of the courses highlighting the focus on employability/ entrepreneurship/ skill development

Scheme for Semester End Examination (ESA)

UNIT	8 Questions to be set of 20 Marks Each	Chapter Numbers	Instructions
I	Q.No.-1, Q.No.-2, Q.No.-3	1,2,3	Solve Any 2
II	Q.No.-4, Q.No.-5, Q.No.-6	4,5,6	Solve Any 2
III	Q.No.-7	7	Solve Any 1
	Q.No.-8	8	



Syllabus copies of the courses highlighting the focus on employability/ entrepreneurship/ skill development

List of Experiments

Program: Bachelor of Engineering		
Course Title: Microcontroller Programming and Interfacing		Course Code: 21ECSC206
L-T-P: 1-0-3	Credits: 4	Contact Hrs: 7hrs/week
ISA Marks: 100	ESA Marks: 0	Total Marks: 100
Teaching Hrs: 15 + 60	Exam Duration:	

Module I		
Lecture /Reading	Introduction to Microcontroller and Embedded System Microcontrollers and General Purpose Microprocessors, Embedded System Features, Choosing a microcontroller, Criteria for choosing a microcontroller, Harvard and Von Neumann Architecture, Introduction to AVR Microcontroller and Arduino Family.	01-hrs
Hands on	<ul style="list-style-type: none"> Introduction to the hardware, setup, familiarizations with the working of the hardware 	03-hrs
Lecture /Reading	AVR Architecture and Assembly Language Programming on AVR Microcontrollers Simplified View of an AVR Microcontroller, Internal Architecture (Harvard) of AVR, Registers and Data Memory in AVR, Instruction format and size in AVR, Using Instructions with Registers and Data Memory, Watch Dog Timer, Flags and Special Function Registers, Data Formats and Assembler directive. Introduction to AVR Assembly Programming, Instruction Types and Instruction Set of AVR (Data Transfer Instructions, Branch Instructions, Bit and Bit test Instructions, Arithmetic and Logic Instructions, MCU Control Instructions, Jump and RET Instruction), Structure of Assembly Program in AVR, asm, lst, map and object files, Executing a program instruction by instruction, RISC Architecture features of AVR Microcontrollers, Viewing registers and memory with AVR Studio IDE.	02-hrs
Hand on	<ul style="list-style-type: none"> Assembly programming on the hardware using appropriate SDK Set of programs to be given on various instruction types/ instruction set HLL Python programming on the hardware 	09-hrs
Review	Review I	03-hrs
Module –II		
Lecture /Reading	AVR Time Delay and Instruction Pipeline Delay Calculation of AVR, AVR Multistage execution Pipeline, Timers/Counters, C Data Types.	01 hrs
Hands on	AVR Timer/Counter Programming	06 hrs
Lecture /Reading	AVR I/O Port Programming I/O Port Pins and their functions, Role of DDR/DDRx Registers in Input and output operations, Programming for I/O Ports, I/O Bit Manipulations,	01 hrs
Hands on	I/O Port programming	06 hrs
Review	Review II	03 hrs
Module –III		
Lecture /Reading	Interrupts in AVR and Interrupt Programming AVR Interrupts, Interrupts vs Polling, Interrupt Service Routine, Steps in executing an interrupt, Sources of Interrupts, Interrupt Priority, Concept of Context Saving in task switching, Enabling and Disabling Interrupts, Programming Timer Interrupts, Programming external interrupts	01 hrs
Hands on	Interrupt Programming	06 hrs
Lecture /Reading	AVR Serial Port Programming	01 hrs



FORM
ISO 9001: 2008
School of Computer Science & Engineering

Syllabus copies of the courses highlighting the focus on employability/ entrepreneurship/ skill development

	Basics of Serial Communication, RS232 standards, RS232 Pins, RS232 Handshaking Signals, ATMEGA32 connections to RS232, Baud Rate and UBRR Register, UDR register and USART, UCSR Registers and USART Configuration, Programming AVR for Serial Communication. Links:	
Hands on	Serial Communication programming	06 hrs
Review	Review III	03 hrs
Module –IV		
Lecture /Reading	LCD and Keyboard Interfacing LCD Interfacing, Sending Commands and Data to LCD (4 Bits and/or 8 Bits at a time).	01 hrs
Hands on	Keyboard Interfacing, Matrix Keyboard connection to AVR Ports, Key Identification,	06 hrs
Lecture /Reading	Chapter No. 8. ADC, DAC and Sensor Interfacing Need for ADC and DAC in Interfacing, ADC Characteristics, ADC devices, and ATmega32 ADC features, Programming A/D Converter	01 hrs
Hands on	DAC Interfacing, Sensor Interfacing	06 hrs
Review	Review IV	
Module –V		
Hands on	Integration of the work done in various modules according to the problem statement	09 hrs
Final Evaluation	Presentation + Project exhibition	03 hrs
Text Books:		
1. Mazidi M. A, Naimi Sarmad, Naimi Sepehr, “The AVR Microcontroller and Embedded System using Assembly and C”, Prentice Hall.		
Reference Books:		
1. J. M. Hughes, “Arduino A Technical Reference”, O’Reilly		

Program: Bachelor of Engineering		
Course Title: Exploratory Data Analysis		Course Code: 21ECSC210
L-T-P: 2-0-2	Credits: 4	Contact Hrs: 6 hrs/week
ISA Marks: 80	ESA Marks: 20	Total Marks: 100
Teaching Hrs: 60	Exam Duration: 3 hrs	Lab slots: 15

Unit –I		
1	Introduction and scientific python: Ecosystem for data science, basic python, numerical and vectorized computation, data manipulation, data visualization.	10 hrs
2	Exploratory Data Analysis: Types of data: categorical, numerical, probability distributions, Descriptive statistics, univariate and multivariate statistics, advanced data visualization, Case study	10 hrs
Unit –II		
3	Data Pre-Preprocessing	10 hrs



FORM
ISO 9001: 2008
School of Computer Science & Engineering

Syllabus copies of the courses highlighting the focus on employability/ entrepreneurship/ skill development

	Data cleaning, data integration, dimensionality reduction: feature selection and feature extraction, data transformation	
4	Supervised Learning Linear and logistic regression, naïve Bayes classifier, K-nearest neighbours	10 hrs
5	Clustering Partitioning-based, hierarchical clustering, density-based clustering	10 hrs
Unit –III		
6	Time-series analysis: Autocorrelation, time-series forecasting, auto regressive moving average models.	10 hrs
Reference Books: <ol style="list-style-type: none">1. Wes McKinney ,Python for Data Analysis, Published by O'Reilly Media, 2nd Edition ,October 2017.2. Jiawei Han, Micheline Kamber and Jian Pei, Data Mining: Concepts and Techniques, 3rd edition, Morgan Kaufmann, 20123. Ian H. Witten, Eibe Frank, Mark A. Hall and Christopher J. Pal, Data Mining: Practical Machine Learning Tools and Techniques, Morgan Kaufmann; 4th edition, 2016.		

Scheme for End Semester Assessment (ESA)

UNIT	8 Questions to be set of 20 Marks Each	Chapter Numbers	Instructions
I	Lab Exam on Course Project	1, 2	Demonstration of Course Project
II		3,4,5	
III		6	



FORM
ISO 9001: 2008
School of Computer Science & Engineering

Syllabus copies of the courses highlighting the focus on employability/ entrepreneurship/ skill development



FORM
ISO 9001: 2008
School of Computer Science & Engineering

Syllabus copies of the courses highlighting the focus on employability/ entrepreneurship/ skill development

Program: Bachelor of Engineering		
Course Title: Object Oriented Programming		CourseCode: 20ECSC204
L-T-P: 3-0-0	Credits: 3	Contact Hrs: 3hrs/week
ISA Marks: 50	ESA Marks: 50	Total Marks: 100
Teaching Hrs: 40	Exam Duration: 3hrs	

Unit –I		
1	Introduction: Introduction to object oriented programming. Characteristics of object oriented languages, Programming Basics, arrays, Functions in C++ (parameter passing techniques.)	4 hrs
2	Classes and Objects: Introduction to Classes and Objects, encapsulation visibility modifiers, constructor and its types, nested classes, String class. UML diagrams to describe classes and relationships.	6 hrs
3	Inheritance: Introduction, types of Inheritance, constructors, Abstract class, Aggregation: classes within classes	6 hrs
Unit –II		
4	Virtual Functions and Polymorphism: Virtual functions, Friend functions, static functions, The 'this' pointer	6 hrs
5	Templates and Exception Handling: Function and class templates. Introduction to exceptions, Throwing an Exception, Try Block, Exception Handler (Catching an Exception), Multiple exceptions. Exceptions with arguments	6hrs
6	Design Patterns: Creational, Structural and Behavioural design patterns.	4 hrs
Unit –III		
7	Streams and Files: Stream classes, File I/O with streams.	4 hrs
8	Standard Template Library: container classes: Sequence and Associative Containers	4 hrs
Textbooks		
1. Robert Lafore, Object oriented programming in C++, 4 th Ed, Pearson education, 2001		
Reference Books		
1. Lippman S B, Lajorie J, Moo B E, C++ Primer, 5Ed, Addison Wesley, 2013.		
2. Herbert Schildt: The Complete Reference C++, 4th Ed, Tata McGraw Hill, 2017		

Scheme for End Semester Assessment (ESA)

UNI T	8 Questions to be set of 20 Marks Each	Chapter Numbers	Instructions
I	Q.No.-1, Q.No.-2, Q.No.-3	1,2& 3	Solve Any 2 out of 3
II	Q.No.-4, Q.No.-5, Q.No.-6	45&6	Solve Any 2 out of 3
III	Q.No.-7	7	Solve Any 1 out of 2
	Q.No.-8	8	



Syllabus copies of the courses highlighting the focus on employability/ entrepreneurship/ skill development

Program: Bachelor of Engineering		
Course Title: Principles of Compiler Design		Course Code: 19ECSC203
L-T-P: 3-1-0	Credits: 3	Contact Hrs: 03 hrs/week
ISA Marks: 50	ESA Marks: 50	Total Marks: 100
Teaching Hrs: 40	Exam Duration: 03 hrs	

Unit –I		
1	Introduction to compilers: Brief History Of Compilers, Translation Process, Major Data Structures In Compilers, Chomsky Hierarchy, Lexical Analysis: Scanning Process, Regular Expressions For Tokens , Lexical Errors, Applications Of Regular Expressions.	06hrs
2	Finite Automata: Introduction: Language, Automata, From Regular Expressions To Deterministic Finite Automata (DFA): C-Nondeterministic Finite Automata (C-NFA), NFA, DFA, DFA Optimization, Finite Automata As Recognizer, Implementation Of Finite Automata	06hrs
3	Introduction to Syntax Analysis: Introduction To Grammars, Context-Free Grammars (Cfgs), Ambiguity In Grammars And Languages, Role Of Parsing.	04 hrs
Unit –II		
4	Top Down Parsing: Introduction, Left Recursion, Left Factoring, LL (1) Parsing, FIRST And FOLLOW Sets, Error Recovery In Top Down Parsing.	08 hrs
5	Bottom up Parsing: Introduction, SLR (1) Parsing, General LR (1) And LALR (1) Parsing, Error Recovery In Bottom Up Parsing.	08 hrs
Unit –III		
6	Semantic Analysis: Attributes And Attributes Grammars, Algorithm For Attribute Computation, Symbol Table, Data Types And Data Checking.	04 hrs
7	Intermediate Code Generation: Intermediate Code And Data Structure For Code Generation, Code Generation Of Data Structure References, Code Generation Of Control Statements.	04 hrs
Text Book:		
<ol style="list-style-type: none"> 1. Alfred V Aho, Monica S. Lam, Ravi Sethi, Jeffrey D Ullman, Compilers - Principles, Techniques and Tools, 2nd Edition, Pearson, 2011. 2. Kenneth C Louden: Compiler Construction Principles & Practice, Cengage Learning, 1997. 		
References:		
<ol style="list-style-type: none"> 1. Andrew W Apple, Modern Compiler Implementation in C, Cambridge University Press, 1999. 2. Charles N. Fischer, Richard J. leBlanc, Jr, Crafting a Compiler with C, Pearson, 2011. 3. Peter Linz, An Introduction to formal languages and Automata, IV edition, Narosa, 2016. 4. Basavaraj S Anami, Karibasappa K.G, Formal Languages and Automata Theory, First, Wiley India, 2011. 		

Tutorial tentative plan



FORM
ISO 9001: 2008
School of Computer Science & Engineering

Syllabus copies of the courses highlighting the focus on employability/ entrepreneurship/ skill development

Expt/Job No	Brief description of experiments	No of slots 1 slot = 2hrs
1	Regular expressions.	01
2	NFA, DFA and DFA optimization.	02
3	Regular and Context free grammars.	01
4	Top down parsing.	01
5	Bottom up parsing.	02
6	Implementation of lexical & syntax analyzer using LEX and YACC tools.	02
7	Design of CFG for validating Natural languages and implement the same.	02

Scheme for End Semester Assessment (ESA)

UNIT	8 Questions to be set of 20 Marks Each	Chapter Numbers	Instructions
I	Q.No.-1, Q.No.-2, Q.No.-3	1, 2 ,3	Solve Any 2
II	Q.No.-4, Q.No.-5, Q.No.-6	4 ,5	Solve Any 2
III	Q.No.-7	6	Solve Any 1
	Q.No.-8	7	



Syllabus copies of the courses highlighting the focus on employability/ entrepreneurship/ skill development

Program: Bachelor of Engineering		
Course Title: Operating Systems Principles and Programming		Course Code: 18ECSC202
L-T-P: 4-0-1	Credits: 5	Contact Hrs: 6
ISA Marks: 50	ESA Marks: 50	Total Marks: 100
Teaching Hrs: 50 + 26	Exam Duration: 3 Hrs	

Unit –I		
1	Introduction Introduction to Operating System, Operations, System components, Overview of UNIX Operating System, UNIX utility commands, UNIX APIs and characteristics.	04 hrs + 04 hrs (Tut)
2	Process Management Process Concept, Process scheduling, Process Control, Process Accounting, Inter-process communication, Multithreading models and Thread API, Thread library, Process scheduling: Basic concepts; Scheduling criteria, Scheduling algorithms	10 hrs + 12 hrs (Tut)
3	Process Synchronization Synchronization, Producer Consumer problem, The critical section problem, Peterson's solution, Synchronization mechanism, Mutex, Semaphores, Classical problems of synchronization.	06 hrs + 04 hrs (Tut)
Unit –II		
4	Deadlocks Deadlock System Model and Deadlock Characterization, Methods for Handling Deadlocks, Deadlock Prevention, Deadlock Avoidance, Deadlock Detection, Recovery from Deadlock	06 hrs + 02 hrs (Tut)
5	File management UNIX File Types, File systems and File Attributes, I-nodes in UNIX, UNIX Kernel Support for Files, Directory Files, Hard and symbolic filenames, General File APIs. File and Record Locking.	07 hrs + 04 hrs (Tut)
6	Memory Management Memory management strategies, Background, Swapping, Contiguous memory allocation, Paging, Structure of page table, Segmentation.	07 hrs
Unit –III		
7	Virtual Memory Management Virtual Memory Management, Background, Demand paging, Page replacement.	5 hrs
8	Case study RT Linux: Features, architecture, components, application program interface, scheduling and threads.	5 hrs
Text Books:		
<ol style="list-style-type: none"> 1. Abraham Silberschatz, Peter Baer Galvin, Greg Gagne: Operating System Principles, 9 ed., Wiley-India, 2019. 2. W. Richard Stevens, Stephen A. Rago, "Advanced Programming in the UNIX Environment", 3 ed. Addison Wesley Professional, 2018 		
Reference Books:		
<ol style="list-style-type: none"> 1. William Stallings, "Operating System Internals and Design Principles", 1 ed., Pearson Education, Asia, 2015 2. Gary Nutt, "Operating System", 3 ed., Pearson Education, 2009 3. Terrence Chan, "Unix System Programming Using C++", 1 ed., Prentice Hall India, 2014 4. Marc J. Rochkind, "Advanced Unix Programming", 2 ed., Pearson Education, 2005. 		



Syllabus copies of the courses highlighting the focus on employability/ entrepreneurship/ skill development

List of Experiments

Expt. No.	Experiments	No. of Slots
1	Process control (Using fork, wait, exec, exit API's)	2
2	Inter Process Communication using Pipes, FIFO's	2
3	Concurrent operations using Threads	2
4	File/ record locking and unlocking using <i>fcntl</i>	1
5	Simulation of CPU scheduling algorithms	1
6	Deadlock avoidance(Banker's algorithm), Deadlock detection	2

Scheme for End Semester Assessment (ESA)

UNIT	8 Questions to be set of 20 Marks Each	Chapter Numbers	Instructions
I	Q.No.-1, Q.No.-2, Q.No.-3	1,2,3	Solve Any 2
II	Q.No.-4, Q.No.-5, Q.No.-6	4,5,6	Solve Any 2
III	Q.No.-7	7	Solve Any 1
	Q.No.-8	8	



FORM
ISO 9001: 2008
School of Computer Science & Engineering

Syllabus copies of the courses highlighting the focus on employability/ entrepreneurship/ skill development

Program: Bachelor of Engineering		
Course Title: Object Oriented Programming Lab		Course Code: 20ECSP203
L-T-P: 0-0-1.5	Credits: 1.5	Contact Hrs: 3 hrs/week
ISA Marks: 80	ESA Marks: 20	Total Marks: 100
Teaching Hrs: 39	Exam Duration: 3hrs	

Experiments Number	Lab assignments/experiment	Number of Slots
1	Demonstration: Introduction to Code Blocks IDE (Integrated Development Environment), C++ programming basics.	4
2	Exercise : Classes and objects, Inheritance, Polymorphism, Templates and Exceptions Handling	4
3	Structured Enquiry : Classes and objects, Inheritance, Polymorphism, Templates and Exceptions Handling	2
4	Open Ended : Data types, Classes and Objects, Inheritance polymorphism, Exception Handling. Design patterns	2

Text Book:

1. Robert Lafore, "Object oriented programming in C++", 4thEd, Pearson education, 2001

Reference Books:

1. Lippman S B, Lajorie J, Moo B E, C++ Primer, 5Ed, Addison Wesley, 2013.
2. Herbert Schildt: The Complete Reference C++, 4th Ed, Tata McGraw Hill, 2017

Evaluation:

Students Assessment through CIE (80%) + SEE (20%)

Continuous Internal Evaluation (80%)	Assessment	Weightage in Marks
	Exercises	40
Semester End Examination (20%)	Structured Enquiry	20
	Open Ended Experiment	20
	Total	100



FORM
ISO 9001: 2008
School of Computer Science & Engineering

Syllabus copies of the courses highlighting the focus on employability/ entrepreneurship/ skill development

Program: Bachelor of Engineering		
Course Title: Software Engineering		Course Code: 15ECSC301
L-T-P: 3-0-0	Credits: 3	Contact Hrs: 3 hrs/week
ISA Marks: 50	ESA Marks: 50	Total Marks: 100
Teaching Hrs: 40	Exam Duration: 3hrs	

Unit –I		
1	Software Engineering Process Professional software development Software engineering ethics, Case studies, Software processes: Software process models, Process activities, Coping with change, The rational unified process, Continuous Integration and Continuous Deployment and Tools.	6 hrs
2	Agile Software Development Agile methods, Plan-driven and agile development, Extreme programming, Agile project management.	4 hrs
3	Requirement Engineering Functional and Non-functional requirements; The software requirements Document, Requirement specification, Requirements Engineering Processes, Requirements elicitation and analysis; Requirements validation; Requirements management	6 hrs
Unit –II		
4	System Modeling Context models, Interaction Models, Structural models, Behavioral models.	6 hrs
5	Architectural Design Architectural Design Decision, Architectural Views, Architectural Patterns, Application Architectures	5 hrs
6	Object-Oriented Design And Implementation Object oriented design using UML, design patterns, Implementation Issues, Open Source Development.	5 hrs
Unit –III		
7	Software Testing Development Testing, Test Driven Development, Release Testing, User Testing	4 hrs
8	Configuration Management Change management, Version management, System building, Release management	4 hrs
Text Books: 1. Ian Somerville, Software Engineering, 10 th , Pearson Ed, 2015		
Reference Books: 1. Roger S. Pressman, Software Engineering: Practitioner's Approach, 7 th Ed, McGraw- , 2007 2. Shari Lawrence Pfleeger, Joanne M. Atlee, Software Engineering Theory and Practice, 3 rd Ed, Pearson, 2006 3. Jalote, P, An Integrated Approach to Software Engineering, 3rd, Narosa Pub, 2005		



Syllabus copies of the courses highlighting the focus on employability/ entrepreneurship/ skill development

Scheme for End Semester Assessment (ESA)

UNIT	8 Questions to be set of 20 Marks Each	Chapter Numbers	Instructions
I	Q.No.-1, Q.No.-2, Q.No.-3	1, 2,3	Solve Any 2
II	Q.No.-4, Q.No.-5, Q.No.-6	4,5,6	Solve Any 2
III	Q.No.-7	7	Solve Any 1
	Q.No.-8	8	



Syllabus copies of the courses highlighting the focus on employability/ entrepreneurship/ skill development

Program: Bachelor of Engineering		
Course Title: Computer Networks – I		Course Code: 19ECSC302
L-T-P: 3-1-0	Credits: 4	Contact Hrs: 66
ISA Marks: 50	ESA Marks: 50	Total Marks: 100
Teaching Hrs: 40	Exam Duration: 3 hrs.	

Unit –I		
1	Introduction Internet, The Network Edge and Core, Protocol Layer and Service Models: OSI and TCP/IP, Networks Attacks, History of Computer Network and Internet.	8 hrs
2	Application Layer Principles of Network Applications , HTTP , SMTP, DNS,DHCP	8 hrs
Unit –II		
3	Transport-Layer Services Introduction, Connectionless Transport, Principles of Reliable Data Transfer Protocol, Connection-Oriented and Connectionless Transport, Principle of Congestion Control, TCP Congestion Control.	8 hrs
4	Network Layer: Data plane Introduction to Data and Control Plane, Virtual Circuit and Datagram Networks, Internet Protocol: Datagram Format, Fragmentation, IP Addressing	8 hrs
Unit –III		
5	Network Layer: Data plane NAT, IPv6, Software Defined Network(SDN)	4 hrs
6	Network Layer: Control Plane and Network Management SDN Control Plane, Network Management and SNMP	4 hrs
Text Books: 1. J. F. Kurose, K. W. Ross, Computer Networking: A Top-Down Approach, 7th Edition, Pearson Education, 2017.		
Reference Books: 1. Peterson, Larry L, Computer networks : A Systems Approach, 5th Edition, The Morgan Kaufmann series in networking, 2012 2. Behrouz A. Forouzan, TCP/IP protocol suite, 4 th , McGraw Hill, 2010.		



Syllabus copies of the courses highlighting the focus on employability/ entrepreneurship/ skill development

Computer Networks-I Tutorial

Sl. No	Exercise	No of Slots (2 hrs)
1	Demonstration of n/w commands and tools.	2
2	Demonstration of socket programming- Connection oriented/Connectionless.	2
3	Application layer protocol implementation - FTP, Mail server, HTTP.	3
4	Demonstration of NS3 / Qualnet tools.	1
5	Performance analysis of TCP, UDP and SCTP.	1
6	Exercise on congestion control techniques.	1
7	Exercise on flow control techniques.	1
8	Design of network topology with IP addressing scheme.	2

Scheme for End Semester Assessment (ESA)

UNIT	8 Questions to be set of 20 Marks Each	Chapter Numbers	Instructions
I	Q.No.-1, Q.No.-2, Q.No.-3	1,2	Solve Any 2
II	Q.No.-4, Q.No.-5, Q.No.-6	3,4	Solve Any 2
III	Q.No.-7	5	Solve Any 1
	Q.No.-8	6	



FORM
ISO 9001: 2008
School of Computer Science & Engineering

Syllabus copies of the courses highlighting the focus on employability/ entrepreneurship/ skill development

Program: Bachelor of Engineering		
Course Title: System Software		Course Code: 17ECSC302
L-T-P: 3-0-0	Credits: 3	Contact Hrs: 3 hrs/week
ISA Marks: 50	ESA Marks: 50	Total Marks: 100
Teaching Hrs: 40	Exam Duration: 3hrs	

Unit –I		
1	Introduction to a Machine Architecture Introduction, System Software and Machine Architecture, Simplified Instructional Computer (SIC) - SIC Machine Architecture, SIC/XE Machine Architecture, SIC and SIC/XE Programming Examples.	6hrs
2	Assembler Basic Assembler Function - A Simple SIC Assembler, Assembler Algorithm and Data Structures, Machine Dependent Assembler Features - Instruction Formats & Addressing Modes, Program Relocation.	9hrs
Unit –II		
3	Assembler M/c Independent Features and Design options Machine Independent Assembler Features: Literals, Symbol Defined Statements, Expression, Program Blocks, Control Sections and Programming Linking, Assembler Design Options: One Pass Assembler, Multi Pass Assembler, Implementation Examples: Assembler(8086): MASM	7 hrs
4	Loaders and Linkers Basic Loader Functions: Design of an Absolute Loader, A Simple Bootstrap Loader, Machine Dependent Loader Features: Relocation, Program Linking, Algorithm and Data Structures for a Linking. Loader M/c Independent Features: Automatic Library Search, Loader Options, Loader Design Options - Linkage Editor, Dynamic Linkage, Bootstrap Loaders, Implementation Examples: 8086 Linker.	8 hrs
Unit –III		
5	Macro Processor Basic Macro Processor Functions: Macro Definitions and Expansion, Macro Processor Algorithm and Data Structures, Machine Independent Macro Processor Features: Concatenation of Macro Parameters, Generation of Unique Labels, Conditional Macro Expansion, Keyword Macro Parameters Implementation Examples: 8086 Macro Processor.	5 hrs
6	Back end of Compiler: Code generation and Machine dependent features. Review of phases of compilers, code generation routines, machine dependent features.	5 hrs
Text Books:		
<ol style="list-style-type: none"> Leland.L.Beck and D. Manjula, System Software, 3rd edition, Pearson Education, 2011. Alfred V Aho, Monica S. Lam, Ravi Sethi, Jeffrey D Ullman, Compilers- Principles, Techniques and Tools, 2nd edition, Addison-Wesley, 2011. 		
Reference Books:		
<ol style="list-style-type: none"> Muhammad Ali Mazidi et al, The 8051 Microcontroller and Embedded systems, 2nd Edition, Pearson education, 2009. 		



FORM
ISO 9001: 2008
School of Computer Science & Engineering

Syllabus copies of the courses highlighting the focus on employability/ entrepreneurship/ skill development

Scheme for End Semester Assessment (ESA)

UNIT	8 Questions to be set of 20 Marks Each	Chapter Numbers	Instructions
I	Q.No.-1, Q.No.-2, Q.No.-3	1, 2	Solve Any 2
II	Q.No.-4, Q.No.-5, Q.No.-6	3,4	Solve Any 2
III	Q.No.-7	5	Solve Any 1
	Q.No.-8	6	



FORM
ISO 9001: 2008
School of Computer Science & Engineering

Syllabus copies of the courses highlighting the focus on employability/ entrepreneurship/ skill development

Program: Bachelor of Engineering		
Course Title: Java Programming		Course Code: 19ECSP301
L-T-P: 1-0-1.5	Credits: 2.5	Contact Hrs: 4hrs/week
ISA Marks: 80	ESA Marks: 20	Total Marks: 100
Teaching Hrs: 52	Exam Duration: 3 hrs	

Unit –I		
1	JAVA Language Fundamentals: Java Features, Programming basics, Arrays and Strings, classes and objects	8hrs
2	Inheritance: Introduction, types of inheritance, static and dynamic polymorphism.	8hrs
3	Interfaces and Exception Handling: Introduction, Create and implement interfaces, Exception handling	
Unit –II		
4	Collections Frame work: Introduction to generic programming, Collections: Interfaces: List, Set, Queue Classes: ArrayList, LinkedList and HashSet, Map	8 hrs
5	Lambda Expressions: Functional programming, Functional interface, Bulk operations on collections	8 hrs
6	Streams API: Basics of Streams, Reduction operations, Iterators and Streams	
Unit –III		
7	GUI Programming: Introduction to swings, User interface design and event handling.	4hrs
8	Java Database Connectivity (JDBC): Introduction, Drivers, Interfaces and classes to develop data base applications, case study	4 hrs
Text Books: 3. Herbert JAVA The Complete Reference, Herbert Schildt, 10th Ed, 2017, McGraw-Hill		
Reference Books: i. Kathy Sierra and Bert Bates, Head First Java: A Brain-Friendly Guide, 2nd Edition, O'Reilly Media ii. Introduction to Java Programming, Liang Y D, Pearson, 11 th Edition		

Scheme for Semester End Examination (ESA)

***Note: This course is a lab course and the ESA is Course Project**

Unit	Course Project for 20 Marks	Chapter Numbers	Instructions
I, II, III	Design and Implementation is evaluated	1,2,3,4,5, 6 and 7	Implement all the concepts studied in java Programming



FORM
ISO 9001: 2008
 School of Computer Science & Engineering

Syllabus copies of the courses highlighting the focus on employability/ entrepreneurship/ skill development

Program: Bachelor of Engineering		
Course Title: Machine Learning		Course Code: 17ECSC306
L-T-P: 2-0-1	Credits: 3	Contact Hrs: 3 hrs/week
ISA Marks: 50	ESA Marks: 50	Total Marks: 100
Teaching Hrs: 50	Exam Duration: 3 hrs	

Unit – 1		
1.	Introduction to machine learning Introduction to Machine Learning, Applications of Machine Learning, Types of Machine Learning: Supervised, Unsupervised and Reinforcement learning, Dataset formats, Features and observations.	5 hrs
2.	Supervised Learning: Linear Regression, Logistic Regression Linear Regression: Single and Multiple variables, Sum of squares error function, The Gradient descent algorithm, Application, Logistic Regression, The cost function, Classification using logistic regression, one-vs.-all classification using logistic regression, Regularization.	7 hrs
Unit – 2		
3.	Supervised Learning: Neural Network Introduction to perceptron learning, Model representation, Gradient checking, Back propagation algorithm, Multi-class classification, and Application- classifying digits. Support vector machines.	6 hrs
4.	Unsupervised Learning : Dimensionality reduction and Learning Theory Expectation Maximization (EM), Factor Analysis, The dimensionality reduction, PCA : PCA for compression, Incremental PCA, Randomized PCA, Kernel PCA , ICA (Independent Component Analysis). Bias/variance tradeoff, Union and Chernoff/ Hoeffding bounds VC dimension.	6 hrs
Unit – 3		
5.	Reinforcement Learning Reinforcement Learning: Introduction, Applications, Model of the environment, Policy search, Learning to optimize rewards and value functions, Evaluating actions: The credit assignment problem, Policy gradients, Markov decision processes, Q-learning.	6 hrs
Text Books: 1. Tom Mitchell., Machine Learning, McGraw Hill, McGraw-Hill Science, 3 rd edition. 2. Christopher Bishop., Pattern Recognition and Machine Learning, Springer, 2006.		
References Books: 1. Hands-On Machine Learning with Scikit-Learn and TensorFlow, Concepts, Tools, and Techniques to Build Intelligent Systems, AurelianGerona, Publisher: O'Reilly Media , July 2016. 2. Advanced Machine Learning with Python Paperback, 28 Jul 2016 by John Hearty.		



FORM
ISO 9001: 2008
School of Computer Science & Engineering

Syllabus copies of the courses highlighting the focus on employability/ entrepreneurship/ skill development

List of experiments:

Experiment No.	Brief description about the experiment	Number of slots
1.	Introduction to Scikit and TensorFlow Simple programs with TensorFlow	1
2.	Linear Regression Nonlinear Regression Logistic Regression Activation Functions	1
3.	Training a multi-layer perceptron using API's	1
4.	Training a neural network – construction, execution and use of neural network.	1
5.	Training Neural Networks - a sequence classifier and to predict time series.	1
6.	Classification of Human Facial Expressions using Neural Networks	1
7.	Principal Component Analysis on <ul style="list-style-type: none">● simple matrix● on iris dataset	1
8.	Course Project : Students in a group of four shall implement machine learning solution to a real world problem using Scikit Ex: <ul style="list-style-type: none">● Sentiment Classification using LSTM , encoder-decoder, Natural Language Processing● Playing Solitaire using CNN and Deep Reinforcement Learning	4

Scheme for End Semester Examination (ESA)

UNIT	6 Questions to be set of 20 Marks Each	Chapter numbers	Instructions
I	Q.No.-1, Q.No.-2	1, 2	Solve
II	Q.No.-4, Q.No.-5	3, 4	Solve
III	Q.No.-7	5	Solve
	Q.No.-8	5	



FORM
ISO 9001: 2008
School of Computer Science & Engineering

Syllabus copies of the courses highlighting the focus on employability/ entrepreneurship/ skill development

List of Experiments

Expt. No.	Experiments	No. of Slots
1	Introduction to Data Science , Basics of Python libraries	2
2	Pre-processing: Assessing and analyzing data, cleaning, transforming and adding new features	2
3	Learning model: Constructing and testing learning model	1
4	Post-processing: Creating final predictions	1

Scheme for End Semester Assessment (ESA)

UNIT	8 Questions to be set of 20 Marks Each	Chapter Numbers	Instructions
I	Q.No.-1, Q.No.-2, Q.No.-3,Q. No- 4	1, 2	Solve Any 3
II	Q.No.-5, Q.No.-6, Q.No.-7,Q.No-8	3, 4,5	Solve Any 3
III	Lab exam	1,2,3,4,5	Lab exam evaluation



FORM
ISO 9001: 2008
School of Computer Science & Engineering

Syllabus copies of the courses highlighting the focus on employability/ entrepreneurship/ skill development

Program: Bachelor of Engineering		
Course Title: System Software Lab		Course Code: 19ECSP302
L-T-P: 0-0-1.5	Credits: 1.5	Contact Hrs: 3 hrs/week
ISA Marks: 80	ESA Marks: 20	Total Marks: 100
Teaching Hrs: 36	Exam Duration: 3hrs	

Sl No	Experiments	Slots/Hrs
1.	Practice programs on user defined functions , structures and programs on file handling	3 hrs
2.	Introduction to basics of given assembly language Programs	3 hrs
3.	Evaluation on given assembly language Program	3 hrs
4.	Implementation of Pass 1 Assembler	3 hrs
5.	Implementation of Pass 2 Assembler	6 hrs
6.	Implementation of Pass 1 Linking loader	3 hrs
7.	Implementation of Pass 2 linking loader	6 hrs
8.	Course Project on identifying machine to implement assembler , learning its architectural features and design Pass 1 Assembler or Pass2 Assembler	6 hrs

Reference Books:

1. Leland.L.Beck and D. Manjula, System Software, 3rd edition, Pearson Education, 2011.
2. Alfred V Aho, Monica S. Lam, Ravi Sethi, Jeffrey D Ullman, Compilers- Principles, Techniques and Tools, 2nd Edition, Addison-Wesley, 2011.



FORM
ISO 9001: 2008
School of Computer Science & Engineering

Syllabus copies of the courses highlighting the focus on employability/ entrepreneurship/ skill development

Program: Bachelor of Engineering		
Course Title: Mini Project		Course Code: 15EC3W301
L-T-P: 0-0-3	Credits: 3	Contact Hrs: 3 hrs/week
CIE Marks: 50	SEE Marks: 50	Total Marks: 100
Teaching Hrs: 39	Exam Duration: 3 Hrs	

Student Evaluation Matrix

Sl. No	Continuous Internal Evaluation	Assessment	Weightage in Marks
1	Review 1 :	Problem identification and Software Requirement Specification (SRS)	10
2.	Review 2 :	Software Design	10
3.	Review 3 :	Construction (testing and final demo)	15
4.		Individual contribution to team	10
5.		Project report	05
Total			50



Syllabus copies of the courses highlighting the focus on employability/ entrepreneurship/ skill development

Program: Bachelor of Engineering		
Course Title: Data Mining & Analysis		Course Code: 18ECSC301
L-T-P: 3-0-1	Credits: 4	Contact Hrs: 5 hrs/week
ISA Marks: 80	ESA Marks: 20	Total Marks: 100
Teaching Hrs: 40	Exam Duration: 3hrs	
Unit –I		
1	Data Pre-Preprocessing Introduction to data mining, Data Warehouse and OLAP Technology for Data mining: Data Warehouse, Multidimensional Data Model, Data Warehouse Architecture, Major tasks in data preprocessing- data reduction, data transformation and data discretization, data cleaning and data integration.	08 hrs
2	Frequent Pattern Mining Frequent item sets and association rules; Item set mining algorithms; Generating association rules; Summarizing item sets: maximal and closed frequent item sets; Interesting patterns: pattern evaluation methods;	08 hrs
Unit –II		
3	Classification Techniques Probabilistic classification: naïve Bayes classifier, K-nearest neighbours; Decision tree classifier: decision tree induction, tree pruning; Model evaluation and selection: metrics, cross validation, random sampling, ROC curves;	08hrs
4	Cluster Analysis Cluster Analysis- Partitioning methods, Hierarchical Methods, Density based methods, Outlier Detection.	08hrs
Unit –III		
5	Advanced Mining Techniques Popular data pre-processing techniques: One hot encoding, stacking; Techniques to improve classification accuracy: ensemble methods, random forests, XGBoosting; Bias-variance trade-off; Post processing: Visualization and Interpretation;	08 hrs
Text Books:		
1. Jiawei Han, MichelineKamber and Jian Pei, Data Mining: Concepts and Techniques, 3rd edition, Morgan Kaufmann, 2012.		
Reference Books:		
1. Ian H. Witten, Eibe Frank, Mark A. Hall and Christopher J. Pal, Data Mining: Practical Machine Learning Tools and Techniques, Morgan Kaufmann; 4th edition, 2016.		
2. Pang-Ning, Michael Steinbach and Vipin Kumar, Introduction to Data Mining, Pearson, International edition, 2016.		
3. Mohammed J. Zaki and Wagner Meira, Jr., Data Mining and Analysis: Fundamental Concepts and Algorithms, Cambridge University Press, 2014.		
4. M. H. Dunham, Data Mining: Introductory and Advanced Topics, Pearson Education, 1st edition, 2006.		



FORM
ISO 9001: 2008
School of Computer Science & Engineering

Syllabus copies of the courses highlighting the focus on employability/ entrepreneurship/ skill development

Program: Bachelor of Engineering		
Course Title: Computer Networks-II		Course Code: 20ECSC303
L-T-P: 3-0-0	Credits: 3	Contact Hrs: 70
ISA Marks: 50	ESA Marks: 50	Total Marks: 100
Teaching Hrs: 30	Exam Duration: 3 hrs	



FORM
ISO 9001: 2008
School of Computer Science & Engineering

Syllabus copies of the courses highlighting the focus on employability/ entrepreneurship/ skill development

Unit –I		
1	Network Layer- Routing Algorithms The Link-State (LS) Routing Algorithm, The Distance-Vector (DV) Routing Algorithm, Hierarchical Routing, Routing in the Internet ,intra-AS Routing in the Internet: RIP , Intra-AS Routing in the Internet: OSPF, Inter-AS Routing: BGP.	08hrs
2	Network Layer Broadcast and Multicast Routing, Broadcast Routing Algorithms, Error Reporting, Multicasting: IGMP Group Management, IGMP Messages, Message Format, and IGMP Operation.	08hrs
Unit –II		
3	Data Link Layer Introduction to the Link Layer, Error-Detection and -Correction Techniques : Parity Checks, Check summing Methods, Cyclic Redundancy Check (CRC),Hamming Code, Multiple Access Links and Protocols: Channel Partitioning Protocols, Random Access Protocols: Aloha, Slotted Aloha, CSMA, CSMA/CD, CSMA/CA, Taking-Turns Protocols, The Link-Layer Protocol for Cable Internet Access.	08hrs
4	Switched Local Area Networks Link-Layer Addressing and ARP, Ethernet and LAN standards, Link-Layer Switches, Virtual Local Area Networks (VLANs),Multiprotocol Label Switching (MPLS), Data Center Networking, Retrospective: A Day in the Life of a Web Page Request.	08hrs
Unit –III		
5	Wireless and Mobile Networks Wireless Links and Network Characteristics, 802.11 Wireless LANs, Architecture, MAC Protocol, Frame, Mobility, Personal Area Networks: Bluetooth and Zigbee.Cellular Networks and Internet Access, Mobility, Mobile IP, Managing Mobility in Cellular Network.	04hrs
6	Multimedia Networking: Multimedia Networking Applications, Streaming Stored Video, Voice-over-IP, Protocols for Real-Time Conversational Applications.	04hrs
Text Books:		
1. J. F. Kurose, K. W. Ross, Computer Networking, A Top-Down Approach, 7th Edition, Pearson Education, 2017		
2. Behrouz A. Forouzan , TCP/IP protocol suite, 4th , McGraw Hill, 2010.		
Reference Books:		
4. Peterson, Larry L, Computer networks : a systems approach, 5th Edition, The Morgan Kaufmann series in networking, 2012		
5. Dimitri P. Bertsekas and Robert G. Gallager, Data Networks (2nd Edition),PHI,2009.		

Scheme for End Semester Assessment (ESA)

UNIT	8 Questions to be set of 20 Marks Each	Chapter Numbers	Instructions
I	Q.No.-1, Q.No.-2, Q.No.-3	1, 2	Solve Any 2
II	Q.No.-4, Q.No.-5, Q.No.-6	3,4	Solve Any 2
III	Q.No.-7	5	Solve Any 1
	Q.No.-8	6	

Program: Bachelor of Engineering		
Course Title: Computer Network Lab		Course Code: 20ECSP305
L-T-P: 0-0-1.5	Credits: 1.5	Contact Hrs: 3hrs/week
ISA Marks: 80	ESA Marks: 20	Total Marks: 100



FORM
ISO 9001: 2008
School of Computer Science & Engineering

Syllabus copies of the courses highlighting the focus on employability/ entrepreneurship/ skill development

Teaching Hrs: 42	Exam Duration: 3 hrs	

List of Experiments

S.No	Experiments	Number of lab Slots (3 hrs)
1.	Demonstration of Mininet.	1
2.	Traffic measurement and traffic volume control using the POX controller.	1
3.	Implementation of load balancing/routing technique.	2
4.	Error Detection and Correction using Socket programming.	1
5.	Demonstration of Junos.	1
6.	Configuration and analysis of VLAN.	1
7.	Configuration and analysis of STP/MPLS.	1
8.	Configuration and analysis of OSPF and BGP routing protocols.	2
9.	Experimental analysis of the Handover Procedure in a WiFi Network.	1
10.	Performance analysis of IEEE 802.11 MAC protocols.	1

Course Content

Course Code: 21ECSC307	Course Title: Blockchain and Distributed Ledgers	
L-T-P : 2-0-1	Credits: 3	Contact Hrs: 30
ISA Marks: 50	ESA Marks: 50	Total Marks: 100
Teaching Hrs: 30	Exam Duration: 3 hrs	



Syllabus copies of the courses highlighting the focus on employability/ entrepreneurship/ skill development

Content	Hrs
Unit – 1	
Introduction Overview of blockchain, Digital Money to Distributed Ledgers, Design Primitives: Protocols, Security, Consensus, Permissions, Privacy, Types of blockchain, blockchain platforms, Blockchain Architecture and use cases, Introduction to Bitcoin	06 hrs
Introduction to cryptography, Symmetric key crypto, Public key crypto: Introduction, RSA, Diffie-Hellman, PKI, Hash Functions: Introduction, SHA, Digital signature Schemes: RSA, Digital Signature Standard, Merkle trees.	06 hrs
Unit – 2	
Consensus Mechanisms and Mining Basic consensus mechanisms, Requirements for the consensus protocols, Proof of Work, Proof of State, Proof of Activity, Practical Byzantine Fault Tolerance (PBFT), Federated PBFT, RAFT, Consensus protocols in Blockchain platforms, Scalability issues of consensus protocols.	06 hrs
Ethereum Ethereum transactions, accounts, smart contracts, smart contract development, Solidity basics, basic contracts, distributed storage and IPFS, Ethereum scaling	06 hrs
Unit – 3	
Blockchain Applications Blockchain in Financial Software and Systems: Settlements, KYC, Insurance Government: Digital identity, land records, public distribution system, social welfare systems, Blockchain for cyber security: Cloud forensics, Identity management, Intrusion detection	06 hrs

References Books

1. Melanie Swan, "Blockchain: Blueprint for New Economy", 1st Edition, O'Reilly Media, 2014.
2. ArshdeepBhaga, Vijay Madiseti, "Blockchain Applications: A Hands-On Approach", 1st Edition, VPT, January 31, 2017.



FORM
ISO 9001: 2008
School of Computer Science & Engineering

Syllabus copies of the courses highlighting the focus on employability/ entrepreneurship/ skill development

Program: Bachelor of Engineering		
Course Title: Web Technologies Lab		Course Code: 21ECSP304
L-T-P: 0-0-2	Credits: 2	Contact Hrs: 4hrs/week
ISA Marks: 80	ESA Marks: 20	Total Marks: 100
Teaching Hrs: 30	Exam Duration: 3 hrs	

1	Introduction to HTML basics, JavaScript Introduction to World Wide Web, Web Application Architecture, HTML Basics, Cascading Style Sheets, JavaScript Basics	4 hrs
2	RESTful API using NodeJS and Express Introduction to Node.js .Building servers using the http and net modules, Node modules and events, Express, REST API client, Postman, Accessing Data, Data Security using Bcrypt. API security using JWT tokens.	12 hrs
3	Angular Building blocks of Angular Apps, Components, Templates, Directives. Services, Dependency injection, Bindings, observables, pipes, component communications, Forms, Interacting with servers using HTTP. RouteGuard, Interceptors, Bundling and deploying applications, Hosting	12 hrs
4	React JSX, React Components, Interaction of Components, Lifecycle methods, Form.	8 hrs
Reference Books:		
<ol style="list-style-type: none"> 1. Robert W. Sebesta."Programming the World Wide Web", Pearson Publications 8th Edition, 2014. 2. Nathan Murray, Felipe Coury, et al, "ng-book: The Complete Guide to Angular", FullStack.io Publications, 2019 3. AzatMardan, "Practical Node.js: Building Real-World Scalable Web Apps", 2nd Edition Apress, 2018. 4. Den Ward, "React Native Cookbook: Recipes for solving common React Native development problems", 2nd Edition, 2019 		

Program: Bachelor of Engineering		
Course Title: Distributed and Cloud Computing		Course Code: 20ECSC305
L-T-P: 2-0-1	Credits: 3	Contact Hrs: 3hrs/week
ISA Marks: 50	ESA Marks: 50	Total Marks: 100
Teaching Hrs: 30	Exam Duration: 3 hrs	



Syllabus copies of the courses highlighting the focus on employability/ entrepreneurship/ skill development

Unit –I		
1	Distributed System Models and Enabling Technologies Scalable Computing over the Internet, Technologies for Network-Based Systems, System Models for Distributed and Cloud Computing	4 hrs
2	Virtual Machines and Virtualization of Clusters Implementation Levels of Virtualization, Virtualization Structures/Tools and Mechanisms, Virtualization of CPU, Memory, and I/O Devices, Virtual Clusters and Resources Management.	4 hrs
3	Cloud Platform Architecture over Virtualized Data Centers Cloud Computing and Service Models, Architectural Design of Compute and Storage Clouds, Public Cloud Platforms.	4 hrs
Unit –II		
4	Cloud Programming and Software Environments Features of Cloud and Grid Platforms, Parallel and Distributed Programming Paradigms, Programming Support of Google App Engine.	4 hrs
5	Cloud Resource Management Policies and mechanisms for resource management, Applications of control theory to task scheduling on a cloud, Scheduling algorithms for computing clouds. Fair queuing, Start-time fair queuing, Borrowed virtual time.	4 hrs
6	Cloud Security Cloud security risks, Privacy; privacy impact assessment, Trust, Security of virtualization. Security risks posed by shared images, Security risks posed by a management OS, Xoar - breaking the monolithic design of the TCB, A trusted virtual machine monitor.	4 hrs
Unit –III		
7	Docker Containers Introduction, Docker swarm, Kubernetes.	3 hrs
8	Building containerized applications Microservice architecture, building micro services and containerized applications.	3 hrs
Text Books:		
6. Kai Hwang, Geoffrey C. Fox, Jack J. Dongarra, Distributed and Cloud Computing from Parallel Processing to the Internet of Things, Elsevier, 2013.		
7. Dan C. Marinescu , Cloud Computing Theory and Practice, Elsevier, 2013.		
8. Nigel Poulton, The Kubernetes Book, Packt Publishing, 2019.		
Reference Books:		
9. RajkumarBuyya, Christian Vecchiola, S.ThamaraiSelvi, Mastering Cloud Computing, McGraw Hil, 2013.		
10. Anthony T. Velte, Toby J. Velte, Robert Elsenpeter, Cloud Computing, A Practical Approach, McGraw Hil, 2010.		

List of Experiments:

Expt./Job No.	Brief description about the experiment/job
1.	Hypervisors (Type-I and Type-II). Virtual machines with Para/Full Virtualization
2.	Implementation of cloud service models(IaaS, PaaS, SaaS)
3.	OS-level virtualization
4.	Building containerized application
5.	Cloud resource scheduling and security mechanisms



Syllabus copies of the courses highlighting the focus on employability/ entrepreneurship/ skill development

Scheme for End Semester Assessment (ESA)

UNIT	8 Questions to be set of 20 Marks Each	Chapter Numbers	Instructions
I	Q.No.-1, Q.No.-2, Q.No.-3	1, 2, 3	Solve Any 2 out of 3
II	Q.No.-4, Q.No.-5, Q.No.-6	4,5,6	Solve Any 2 out of 3
III	Q.No.-7	7	Solve Any 1 out of 2
	Q.No.-8	8	



Syllabus copies of the courses highlighting the focus on employability/ entrepreneurship/ skill development

Program: Bachelor of Engineering		
Course Title: Internet of Things		Course Code: 17ECSE303
L-T-P: 2-0-1	Credits: 3	Contact Hrs: 4 hrs/week
ISA Marks: 50	ESA Marks: 50	Total Marks: 100
Teaching Hrs: 30 hrs	Exam Duration: 3 hrs	

Unit –I		
1	Introduction to Internet of Things (IoT) Definition & Characteristics of IoT, Things in IoT, IoT protocols, IoT functional blocks, communication models and APIs.	4 hrs
2	IoT Architecture Enabling technologies: Sensors, Zigbee, Bluetooth/BLE, IoT ecosystem, Data Link protocols: IEEE 802.15.4e, IEEE 802.11 ah, DASH7, Low Power Wide Area Network (LPWAN), NB-IoT, LoRa	4 hrs
3	Network protocols Routing Protocol for Low-Power and Lossy Networks (RPL), cognitive RPL (CORPL), Channel-Aware Routing Protocol (CARP), Low power Wireless Personal Area Networks (LoWPAN), IPV6, 6LoWPAN, Route-Over & Mesh-Under techniques	4 hrs
Unit –II		
4	Application and Security protocols Message Queue Telemetry Transport (MQTT), MQTT for Sensor Networks, Secure MQTT, Advanced Message Queuing Protocol (AMQP), Constrained Application Protocol (CoAP), OPC UA, TLS/DTLS, LWM2M, oneM2M	4 hrs
5	IoT Platforms Design Methodology IoT Design Methodology, Case Study on IoT System for Weather Monitoring etc., Basic building blocks of an IoT device, Raspberry Pi, interface (serial, SPI, I2C), IoT Operating Systems: Contiki, RIOT; IETF Device Classes, Microcontrollers & RF; Power Management in IoT.	4 hrs
6	Programming with Raspberry Pi & WiFi controllers (CC3220/ESP8266) & 6LoWPAN Controller (CC2650) XML, JSON, SOAP and REST-based approach, WebSocket protocol.	4 hrs
Unit –III		
7	IoT prototyping Business models, example applications: Case studies on Home automation, Cities, Environment, Energy, Agriculture, Health with emphasis on data analytics and security. Industrial IoT (IIoT), Role of AI/ML in IoT.	6 hrs
Text Books:		
<ol style="list-style-type: none"> ArshdeepBahga, Vijay Madiset , Internet of Things (A Hands-on-Approach) Universities Press- 2014 Olivier Hersent, David Boswarthick, Omar Elloumi, The Internet of Things: Key Applications and Protocols, John Wiley & Sons – 2012. 		
Reference Books:		
<ol style="list-style-type: none"> Subhas Chandra Mukhopadhyay ,Internet of Things Challenges and Opportunities Springer- 2014. Zach Shelby, Carsten Bormann, “6LoWPAN: The Wireless Embedded Internet”, Wiley - 2009. 		

List of Experiments



FORM
ISO 9001: 2008
School of Computer Science & Engineering

Syllabus copies of the courses highlighting the focus on employability/ entrepreneurship/ skill development

Expt./Job No.	Brief description about the experiments	No. of Lab slots per batch (estimate)
1.	Programming with Raspberry Pi	3
2.	Cloud service interface for data storage and retrieval	2
3.	Performance analysis of Data link protocols, routing and application protocols	3
4.	Open Ended Experiment with focus on data analytics and security	2

Scheme for Semester End Examination (SEE)

UNIT	8 Questions to be set of 20 Marks Each	Chapter Numbers	Instructions
I	Q.No.-1, Q.No.-2, Q.No.-3	1, 2,3	Solve Any 2 out of 3
II	Q.No.-4, Q.No.-5, Q.No.-6	4,5,6	Solve Any 2 out of 3
III	Q.No.-7	7	Solve Any 1 out of 2



FORM
ISO 9001: 2008
School of Computer Science & Engineering

Syllabus copies of the courses highlighting the focus on employability/ entrepreneurship/ skill development



FORM
ISO 9001: 2008
School of Computer Science & Engineering

Syllabus copies of the courses highlighting the focus on employability/ entrepreneurship/ skill development

Program: Bachelor of Engineering		
Course Title: Algorithmic Problem Solving		Course Code: 17ECSE309
L-T-P: 0-0-6	Credits: 6	Contact Hrs: 74 hrs
ISA Marks: 70	ESA Marks: 30	Total Marks: 100
Teaching Hrs: 74 hrs	Exam Duration: 2-3 days	

Unit –I		
1	Building Blocks, Strategies and Performance Understanding Coding Platforms and Tools, Data Structures and Algorithms Revisited, Warm up Problems, Parsing and Formatting Text, Code Performance Analysis and Tools	12 hrs
2	Advanced Data Structures Matrix, Grids, Trees and variants, Lists, Skip lists, Hash, Trie and variants	10 hrs
3	Dynamic Programming Memory Functions, Optimization Problems	8 hrs
Unit –II		
4	Graph algorithms Traversal Algorithms, Shortest Path Algorithms, Spanning Tree Algorithms and Variants	25 hrs
5	Introduction to Computational Geometry Points, Line Segments, Polygons and Basics of Geometric Problems	5 hrs
Unit –III		
6	Chapter 6: Problem Solving Assortment of Problems and Techniques	14 hrs
Text Books: 1. Levitin A., Introduction to the Design and Analysis of Algorithms, Third Edition, Pearson Education, 2017. 2. Levitin A, Levitin M, Algorithmic Puzzles, First Edition, Oxford University Press, 2011.		
References: 1. Thomas H. Cormen, Charles E. Leiserson, Ronald L. Rivest, Clifford Stein, Introduction to Algorithms, Third Edition, MIT Press, 2010. 2. HackerRank / CodeChef Platforms		



FORM
ISO 9001: 2008
School of Computer Science & Engineering

Syllabus copies of the courses highlighting the focus on employability/ entrepreneurship/ skill development

Program: Bachelor of Engineering		
Course Title: Computer Vision		Course Code: 18ECSE301
L-T-P: 2-0-1	Credits: 3	Contact Hrs: 3hrs/week
ISA Marks: 80	ESA Marks: 20	Total Marks: 100
Teaching Hrs: 30	Lab Slots: 10	Exam Duration: 3 hrs

Unit – 1		
1	Introduction Computer Vision Overview, Pixels and image representation, Filters: Linear systems, Convolutions and cross-correlations; Lab: Basics, Filters	4hrs
2	Features and filtering Edge detection: Gaussian, Sobel filters, Canny edge detector, Features and fitting: RANSAC Local features, Harris corner detection, Feature descriptors: Difference of gaussians, Scale invariant feature transform; Lab: Filters, Edges, Features	8hrs
Unit – 2		
3	Semantic segmentation Perceptual grouping, Agglomerative clustering, Super pixels and over segmentation; Clustering: K-means, Mean shift; Visual Bag of Words: Texture features, Visual bag of words; Lab: Resizing, clustering, recognition	6 hrs
4	Motion Optical Flow, Lucas-Kanade method, Horn-Schunk Method, Pyramids for large motion, Tracking: Feature Tracking, Lucas KanadeTomasi (KLT) tracker; Lab: Object detection, optical flow	6hrs
Unit – 3		
5	Advanced Techniques Image stitching, Image pyramids, Object recognition, Dimensionality reduction, Face identification, Detecting objects by parts	6hrs
Reference Books:		
<ol style="list-style-type: none"> 1. Richard Szeliski, Computer Vision: Algorithms and Applications, Springer, 2011. 2. D. Forsyth and J. Ponce, Computer Vision: A Modern Approach, Pearson Education India, 2ndEd, 2015. 3. R. I. Hartley and A. Zisserman, Multiple View Geometry in Computer Vision, Cambridge University Press, 2nd Edition, 2004. 		

Scheme for End Semester Assessment (ESA)

UNIT	8 Questions to be set of 20 Marks Each	Chapter Numbers	Instructions
I	Q.No.-1, Q.No.-2, Q.No.-3	1, 2	Solve Any 3 out of 4
II	Q.No.-4, Q.No.-5, Q.No.-6	3, 4	Solve Any 3 out of 4
III	Lab exam	5	Lab exam evaluation



Syllabus copies of the courses highlighting the focus on employability/ entrepreneurship/ skill development

Program: Bachelor of Engineering		
Course Title: Embedded Intelligent Systems		Coursecode: 18ECSE302
L-T-P: 0-0-3	Credits: 3	Contact Hrs: 6hrs/week
ISA Marks: 80	ESA Marks: 20	Total Marks: 100
Teaching Hrs: 60	Exam Duration: 3 hrs	
1	Basics of embedded systems Linux Application Programming, System V IPC, . Linux Kernel Internals and Architecture , Kernel Core , Linux Device Driver Programming, Interrupts & Timers ,Sample shell script, application program, driver source build and execute	10 hrs
2	Heterogeneous computing Basics of heterogeneous computing with various hardware architectures designed for specific type of tasks, Advanced heterogeneous computing with a.Introduction to Parallel programming b.GPU programming (OpenCL)c. Open standards for heterogeneous computing (Openvx) ,Basic OpenCL examples - Coding, compilation and execution	12hrs
3	ML Frameworks lab with the target device Caffe, tensorflow, TF Lite machine learning frameworks & architecture ,Modelparsing, feature support and flexibility,Supported layers , advantages and disadvantages with each of these frameworks, Android NN architecture overview , Full stack compilation and execution on embedded device	16hrs
4	Model Development and Optimization Significance of on device AI,Quantization , pruning, weight sharing, Distillation,Various pre-trained networks and design considerations to choose a particular pre-trained model ,Federated Learning , Flexible Inferencing	8hrs
5	Android Anatomy Android Architecture ,Linux Kernel , Binder , HAL Native Libraries , Android Runtime, Dalvik Application framework , Applications, IPC	8hrs
Text Books		
<ol style="list-style-type: none"> Linux System Programming , by Robert Love , Copyright © 2007 O'Reilly Media Heterogeneous Computing with OpenCL, 2nd Edition by Dana Schaa, Perhaad Mistry, David R. Kaeli, Lee Howes, Benedict Gaster , Publisher: Morgan Kaufmann 		
Reference Books:		
<ol style="list-style-type: none"> Deep Learning , MIT Press book ,Goodfellow, Bengio, and Courville's Beginning Android , by Wei-Meng Lee , Publisher: Wrox , O'Reilly Media 		

Scheme for End Semester Assessment (ESA)

UNIT	Experiments to be set of 10 Marks Each	Chapter Numbers	Instructions
I	Project Examination	1,2,3,4,5	Project implementation and demonstration 20 marks



Syllabus copies of the courses highlighting the focus on employability/ entrepreneurship/ skill development

Program: Bachelor of Engineering		
Course Title: Parallel Computing		Course Code: 17ECSE307
L-T-P: 3-0-0	Credits: 3	Contact Hrs: 03 hrs/week
ISA Marks: 50	ESA Marks: 50	Total Marks: 100
Teaching Hrs: 43	Exam Duration: 03hrs	

Unit –I		
1	Introduction to Parallel Computing & Parallel Programming Platforms Motivating Parallelism, Scope of Parallel Computing, Implicit Parallelism: Trends in Microprocessor Architectures, Limitations of Memory System Performance, Dichotomy of Parallel Computing Platforms, Physical Organization of Parallel Platforms, Communication Costs in Parallel Machines.	8 hrs
2	Principles of Parallel Algorithm Design Preliminaries, Decomposition Techniques, Characteristics of Tasks and Interactions, Mapping Techniques for Load Balancing, Methods for Containing Interaction Overheads, Parallel Algorithm Models.	8 hrs
Unit –II		
3	Analytical Modeling of Parallel Programs Sources of Overhead in Parallel Programs, Performance metrics for parallel systems, The effect of Granularity on performance, Scalability of Parallel Systems, Minimum execution time and minimum cost optimal execution time, Asymptotic analysis of Parallel programs, Other Scalability Metrics.	8 hrs
4	Programming Using the Message Passing Paradigm Principles of Message – Passing Programming, The Building Blocks, and MPI: The Message passing Interface, Overlapping Communication with Computation, Collective Communication and Computation Operations, Groups & Communicators.	8 hrs
Unit –III		
5	Pthreads and Synchronization Thread Basics, POSIX Thread API, Synchronization Primitives in Pthreads, Controlling Thread and Synchronization Attributes, Thread Cancellation, Composite Synchronization Constructs.	4 hrs
6	OpenMP Open MP programming model, Specifying tasks in openMP, Synchronization constructs in openMP, Data handling in OpenMP, Open MP library functions, Environment variables in OpenMP, Explicit Thread versus OpenMP based programming.	4 hrs
Text Books: 1. Ananth Grama, George Karypis, Vipin Kumar and Anshul Gupta, Introduction to Parallel Computing, Second Edition, Pearson India, 2013		
Reference Books: 1. Michael Quinn, Parallel Computing Theory and Practice, Tata McGraw Hill, 2003		



Syllabus copies of the courses highlighting the focus on employability/ entrepreneurship/ skill development

Scheme for End Semester Assessment (ESA)

UNIT	8 Questions to be set of 20 Marks Each	Chapter Numbers	Instructions
I	Q.No.-1, Q.No.-2, Q.No.-3	1, 2	Solve Any 2
II	Q.No.-4, Q.No.-5, Q.No.-6	3,4	Solve Any 2
III	Q.No.-7	5	Solve Any 1
	Q.No.-8	5	



Syllabus copies of the courses highlighting the focus on employability/ entrepreneurship/ skill development

Program: Bachelor of Engineering		
Course Title: Quantum Computing		Course Code: 17ECSE306
L-T-P: 3-0-0	Credits: 3	Contact Hrs: 3hrs
ISA Marks: 50	ESA Marks: 50	Total Marks: 100
Teaching Hrs: 40	Exam Duration: 3hrs	

Unit –I		
1	Introduction and Background: Overview, Computers and the Strong Church–Turing Thesis, The Circuit Model of Computation, A Linear Algebra Formulation of the Circuit Model, Reversible Computation, A Preview of Quantum Physics, Quantum Physics and Computation	6 hrs
2	Linear Algebra and the Dirac Notation: The Dirac Notation and Hilbert Spaces, Dual Vectors, Operators, The Spectral Theorem, Functions of Operators, Tensor Products, The Schmidt Decomposition Theorem, Some Comments on the Dirac Notation	6 hrs
3	Introduction to Quantum Toolbox in Python: Installation, Basics and Quantum mechanics	4 hrs
Unit –II		
4	Qubits and the Framework of Quantum Mechanics: The State of a Quantum System, Time-Evolution of a Closed System, Composite Systems, Measurement, Mixed States and General Quantum Operations, Mixed States, Partial Trace, General Quantum Operations	6 hrs
5	A Quantum Model of Computation: The Quantum Circuit Model, Quantum Gates, 1-Qubit Gates, Controlled-U Gates, Universal Sets of Quantum Gates, Efficiency of Approximating Unitary Transformations, Implementing Measurements with Quantum Circuits	6 hrs
6	Exploring Python for Solving Problems / Projects using Quantum Computing.	4 hrs
Unit –III		
7	Introductory Quantum Algorithms: Probabilistic Versus Quantum Algorithms, Phase Kick-back, The Deutsch Algorithm, The Deutsch–Jozsa Algorithm, Simon’s Algorithm	4 hrs
8	Case Studies and Projects done during the course: Image processing, Data Sciences, Machine Learning, Networking	4 hrs
Text Books		
1. Phillip Kaye, Raymond Laflamme and Michele Mosca “An Introduction to Quantum Computing “, Oxford University, Press, 2007		
2. User Guide - Quantum Toolbox in Python, Release 4.2.0 – Qutip.org		

Scheme for End Semester Assessment (ESA)

UNIT	8 Questions to be set of 20 Marks Each	Chapter Numbers	Instructions
I	Q.No.-1, Q.No.-2, Q.No.-3	1, 2,3	Solve Any 2
II	Q.No.-4, Q.No.-5, Q.No.-6	4,5,6	Solve Any 2
III	Q.No.-7	7	Solve Any 1
	Q.No.-8	8	



FORM
ISO 9001: 2008
School of Computer Science & Engineering

Syllabus copies of the courses highlighting the focus on employability/ entrepreneurship/ skill development

Program: Bachelor of Engineering		
Course Title: Web Technologies Lab		Course Code: 18ECSP304
L-T-P: 0-0-2	Credits: 2	Contact Hrs: 4hrs/week
ISA Marks: 80	ESA Marks: 20	Total Marks: 100
Teaching Hrs: 32	Exam Duration: 3 hrs	

1	<p>Javascript Frameworks</p> <p>Introduction to HTML, CSS, and JavaScript Basics</p> <p>Angular 4: Introduction, Navigation: Angular router, Dependency injection, Bindings, observables, and pipes, component communications, forms, Interacting with servers using HTTP and Web Sockets, Bundling and deploying applications.</p> <p>Node.js Introduction to Node.js Building servers using the http and net modules, Node modules and events, Express, Accessing Data..</p>	20hrs
2	<p>Python Frameworks</p> <p>Introduction to Python Frameworks, components of frameworks, building RESTful web services.</p>	6 hrs
3	<p>Using Python full stack frameworks</p> <p>Django: Introduction to Django, Django's take on MVC: Model, View and Template, Django Forms: Form classes, Validation, Authentication, Advanced Forms processing techniques, working with databases, Integrate with RESTful web services.</p>	6 hrs
<p>Reference Books:</p> <ol style="list-style-type: none"> 1. Robert W. Sebesta."Programming the World Wide Web", Pearson Publications 8th Edition, 2014. 2. Felipe Coury, Ari Lerner et.al, "ng-book: The Complete Guide to Angular4", FullStack.io Publications, 2017. 3. AzatMardan, "Practical Node.js: Building Real-World Scalable Web Apps", 2nd Edition Apress, 2018. 4. Daniel Rubio,"BeginningDjango: Web Application Development and Deployment with Python" 1st edition, ApressPublication , 2017. 		

Tentative Lab Plan

Expt./ Job No.	Lab assignments/experiment	No. of Lab. Slots per batch (estimate)
1	Demonstration on HTML ,CSS, Javascript	02
2	Demonstration on Angular.js	02
2	Exercise on Angular.js	01
3	Demonstration on Node.js	02
4	Exercise on Node.js	01
5	Demonstration on Django	02
6	Exercise on Django	01
9	Structured enquiry 1 – JavaScript Framework	02
10	Structured enquiry 2 – Django	02



Syllabus copies of the courses highlighting the focus on employability/ entrepreneurship/ skill development

Course Code: 21ECSC307	Course Title: Blockchain and Distributed Ledgers	
L-T-P : 2-0-1	Credits: 3	Contact Hrs: 30
ISA Marks: 50	ESA Marks: 50	Total Marks: 100
Teaching Hrs: 30		Exam Duration: 3 hrs

Content	Hrs
Unit – 1	
Introduction Overview of blockchain, Digital Money to Distributed Ledgers, Design Primitives: Protocols, Security, Consensus, Permissions, Privacy, Types of blockchain, blockchain platforms, Blockchain Architecture and use cases, Introduction to Bitcoin	06 hrs
Introduction to cryptography, Symmetric key crypto, Public key crypto: Introduction, RSA, Diffie-Hellman, PKI, Hash Functions: Introduction, SHA, Digital signature Schemes: RSA, Digital Signature Standard, Merkle trees.	06 hrs
Unit – 2	
Consensus Mechanisms and Mining Basic consensus mechanisms, Requirements for the consensus protocols, Proof of Work, Proof of State, Proof of Activity, Practical Byzantine Fault Tolerance (PBFT), Federated PBFT, RAFT, Consensus protocols in Blockchain platforms, Scalability issues of consensus protocols.	06 hrs
Ethereum Ethereum transactions, accounts, smart contracts, smart contract development, Solidity basics, basic contracts, distributed storage and IPFS, Ethereum scaling	06 hrs
Unit – 3	
Blockchain Applications Blockchain in Financial Software and Systems: Settlements, KYC, Insurance Government: Digital identity, land records, public distribution system, social welfare systems, Blockchain for cyber security: Cloud forensics, Identity management, Intrusion detection	06 hrs



FORM
ISO 9001: 2008
School of Computer Science & Engineering

Syllabus copies of the courses highlighting the focus on employability/ entrepreneurship/ skill development

Program: Bachelor of Engineering		
Course Title: Semantic Web		Course Code: 19ECSE303
L-T-P: 3-0-0	Credits: 3	Contact Hrs: 40
ISA Marks: 50	ESA Marks: 50	Total Marks: 100
Teaching Hrs: 40	Exam Duration: 03 hrs	

Unit –I		
1	Introduction to Semantics History of the Web, Limitations, Vision of Semantic Web, Principles, Data Integration Across Web, Data Modeling Methods, Semantic Relationships, Metadata, Perpetual Data	4 hrs
2	Expressing Meaning Triple Store, Merging Graphs, Querying: Case Study	4 hrs
3	Using Semantic Data Query Language, Feed Forward Inference, Searching for Connections, Linked Data, Freebase	8 hrs
Unit –II		
4	Working with Semantics RDF—The Basis of the Semantic Web, OWL, Metadata with RDF, Metadata Taxonomies, Ontology	8 hrs
5	Reasoning and Social Web Reasoning types: Approximate Reasoning and Bounded Reasoning, Social Semantic Web, Semantic Crawlers	8 hrs
Unit –III		
6	Semantic Modeling Semantic Modeling, Semantic Web Applications, Logic for Semantic Web, Case Studies: Dr. Watson, Yahoo! SearchMonkey	8 hrs
Text Books		
<ol style="list-style-type: none"> Grigoris Antoniou, Paul Groth, Frank van Harmelen and Rinke Hoekstra, A Semantic Web Primer, MIT Press; 3rd edition, 2012. Toby Segaran, Colin Evans, and Jamie Taylor, Programming the Semantic Web: Build Flexible Applications with Graph Data, O'Reilly Media; 2 edition, July 2009. 		
Reference Books:		
<ol style="list-style-type: none"> Pascal Hitzler, Markus Krötzsch, Sebastian Rudolph, Foundations of Semantic Web Technologies, Chapman and Hall; 1st edition, 2009. Dean Allemang, and James Hendler, Semantic Web for the Working Ontologist, Effective Modeling in RDFS and OWL, Morgan Kaufmann; 2nd edition, 2011. John Hebel, Matthew Fisher, Ryan Blace, Andrew Perez-Lopez, and Mike Dean (Foreword), Semantic Web Programming, Wiley Publishers, 1 edition 2009. 		

Scheme for End Semester Assessment (ESA)

UNIT	8 Questions to be set of 20 Marks Each	Chapter Numbers	Instructions
I	Q.No.-1, Q.No.-2, Q.No.-3	1, 2,3	Solve Any 2
II	Q.No.-4, Q.No.-5, Q.No.-6	4,5	Solve Any 2
III	Q.No.-7	6	Solve Any 1
	Q.No.-8	6	



FORM
ISO 9001: 2008
 School of Computer Science & Engineering

Syllabus copies of the courses highlighting the focus on employability/ entrepreneurship/ skill development

Program: Bachelor of Engineering		
Course Title: Data Integration and Cloud Services (0-0-3)		Coursecode: 21ECSE332
L-T-P: 0-0-3	Credits: 3	Contact Hrs: 6hrs/week
ISA Marks: 80	ESA Marks: 20	Total Marks: 100
Teaching Hrs: 60	Exam Duration: 3 hrs	
1	Data Integration for Developers: Introduction to PowerCenter, Folders, Sources, and Targets, Design Objects, File Lookups, Relational Lookups, Database Joins in PowerCenter, Workflow Logic, Merging, Routing, and Sorting Data, Command Tasks, Debugging, Parameterization, Updating Database Tables, Mapplets, Mapping Design Workshop, Addendum.	20 hrs
2	PowerCenter Architecture and Transformations: PowerCenter 10 Architecture, Parameter Files, User-Defined and Advanced Functions, Pivoting Data, Dynamic Lookups, Stored Procedure and SQL Transformations, Troubleshooting Methodology and Error Handling, Transaction Processing, Transaction Control Transformation, Recovery, Command Line Programs, Performance Tuning Methodology, Performance Tuning Mapping Design, Memory Optimization, Performance Tuning: Pipeline Partitioning.	20 hrs
3	Cloud Application Integration Services: Overview of Cloud Application Integration, Understand the Basics: Process Designer, Working with Assets, Adding Web Services to a Process, Fault Handling, Introduction to Guides Designer, API Management, CAI and CDI Integration, Troubleshooting, Tips & Tricks, Best Practices.	10 hrs
4	Cloud Data Integration Services: Informatica Cloud Overview, Runtime Environments and Connections, Synchronization Task, Cloud Mapping Designer, Cloud Mapping Designer – Transformations, Mapping Parameters, Expression Macro and Dynamic Linking, Replication Task, Masking Task, Mass Ingestion Task, Task flows, Hierarchical Connectivity, Intelligent Structure Model.	10 hrs
Text book: 1. Learning Informatica PowerCenter 10.X, Second Edition, Rahul Malewar, Publisher: Packt, 2017.		
Reference book: 1. Data Mining Concepts and Techniques, Third Edition, Jiawei Han, Micheline Kamber, Jian Pei, Publisher: Elsevier, 2012.		

Course Title: The ARM Architecture		Coursecode: 19ECSE302
L-T-P: 2-1-0	Credits: 3	Contact Hrs: 4 hrs/week
ISA Marks: 50	ESA Marks: 50	Total Marks: 100
Teaching Hrs: 30	Exam Duration: 3 hrs	



FORM
ISO 9001: 2008
School of Computer Science & Engineering

Syllabus copies of the courses highlighting the focus on employability/ entrepreneurship/ skill development

Unit –I		
1	ARM Embedded Systems and Processor Fundamentals The RISC Design Philosophy , The ARM Design Philosophy, Embedded System Hardware, Embedded System Software, Registers, Current Program Status Register, Pipeline, Exceptions, Interrupts, and the Vector Table, Core Extensions, Architecture Revisions, ARM Processor Families	06 hrs
2	Introduction to the ARM Instruction Set & Assembly Programming Data Processing Instructions, Branch Instructions, Load-Store Instructions, Software Interrupt Instruction, Program Status Register Instructions, Loading Constants, ARMv5E Extensions, Conditional Execution, Thumb instruction set.	06 hrs
Unit –II		
3	Efficient C Programming Overview of C Compilers and Optimization, Basic C Data Types, C Looping Structures, Register Allocation, Function Calls, Pointer Aliasing, Structure Arrangement, Bit-fields, Unaligned Data and Endianness, Division.	06 hrs
4	Writing and Optimizing ARM Assembly Code Writing Assembly Code, Profiling and Cycle Counting, Instruction Scheduling, Register Allocation, Conditional Execution, Looping Constructs, Bit Manipulation, Efficient Switches, Handling Unaligned Data.	06 hrs
Unit –III		
5	Introduction to LPC-2148 controller Input output Ports, Pin select registers, Input output select registers, direction control and control registers, Introduction to interfacing standards	03 hrs
6	ARM Interfacing ARM interfacing to peripherals like LED, LCD, Seven segments, Motors, Converters, Keypad.	03 hrs
Text Books 1. Andrew N.Sloss et al, ARM System Developer’s Guide- Designing and Optimizing System Software		
Reference Books: 1. Marilyn Wolf, Computers as Components: Principles of embedded computing system design, Morgan Ka, 2012 2. Steve Furber, ARM System-on-chip Architecture, 2, Pearson, 2000		

Tutorial Plan

Expt./ Job No.	assignments/experiment	No. of Lab. Slots per batch (estimate)
1	ALP on arithmetic instructions set	01
2	ALP on logical instructions set	01
3	ALP on loop and branch instructions	01
4	Interface LED and Seven segments to ARM for displaying message.	01
5	Interface LCD to ARM for displaying message.	01
6	Interface Keypad to read the characters	01
7	Rotate DC and stepper motor for variable speed and direction	01
8	Interface DAC to ARM controller	01

Scheme for End Semester Assessment (ESA)

UNIT	8 Questions to be set of 20 Marks Each	Chapter Numbers	Instructions
I	Q.No.-1, Q.No.-2, Q.No.-3	1,2	Solve Any 2 out of 3
II	Q.No.-4, Q.No.-5, Q.No.-6	3,4	Solve Any 2 out of 3
III	Q.No.-7, 8	5	Solve Any 1 out of 2



FORM
ISO 9001: 2008
School of Computer Science & Engineering

Syllabus copies of the courses highlighting the focus on employability/ entrepreneurship/ skill development



FORM
ISO 9001: 2008
School of Computer Science & Engineering

Syllabus copies of the courses highlighting the focus on employability/ entrepreneurship/ skill development

Program: Bachelor of Engineering		
Course Title: Minor Project		Course Code: 15ECSW302
L-T-P: 0-0-6	Credits: 6	Contact Hrs: 3 hrs/week
ISA Marks: 50	ESA Marks: 50	Total Marks: 100
Teaching Hrs: 39	Exam Duration: 3hrs	

Sixth semester minor project themes:

Networking	Data Engineering	System Engineering
<ul style="list-style-type: none"> ● Internet of Things ● Cloud Computing ● SDN(Software Defined Network) ● SNA(Social Network Analysis) 	<ul style="list-style-type: none"> ● Data Analytics <p><i>Data Processing:</i></p> <ul style="list-style-type: none"> ● Image and video processing ● Computer Vision and Graphics ● NLP(Natural Language Processing) 	<ul style="list-style-type: none"> ● Parallel Computing ● HPC(High Performance Computing) ● Parallel system design

Student Evaluation Matrix:

Project will have 3 internal reviews as follows:

Continuous internal Evaluation	Review Expectation
Review-1	Problem Definition and Synopsis
Review-2	Requirements, Algorithms, Design
Review-3	Implementation

Scheme for End Semester Assessment (ESA)

Sl.No	Expectation	Marks
1	Write up 1. Problem Statement. 2. Existing and Proposed system. 3. System Model with brief description. 4. Functional and Non Functional Requirements.	05
2	Presentation: Prepare minimum of 15-18 slides of presentation with consultation of your respective guides.	08
3	Demo (Complete execution of the project with results) and Viva voce.	25
4.	Project Report.	12



FORM
ISO 9001: 2008
School of Computer Science & Engineering

Syllabus copies of the courses highlighting the focus on employability/ entrepreneurship/ skill development

Program: Bachelor of Engineering		
Course Title: Big Data and Analytics		Course Code: 17ECSC401
L-T-P: 2-1-0	Credits: 3	Contact Hrs: 4 hrs/week
ISA Marks: 50	ESA Marks: 50	Total Marks: 100
Teaching Hrs: 54		Exam Duration: 3 hrs

Unit –I		
1	Introduction : What is Big Data?, Data Analytics, Data Analytics Life Cycle, Big Data Characteristics, Different Types of Data.	4 hrs
2	Big Data Storage : Clusters, File Systems and Distributed File Systems, NoSQL, Sharding, Replication, Combining Sharding and Replication. On Disk Storage Devices, In-memory Storage Devices. Sharding, Replication, Combining Sharding and Replication.	6 hrs
3	Big Data Processing : Parallel Data Processing, Distributed Data Processing, Hadoop, Map Reduce	3 hrs
Unit –II		
4	Big Data Modeling: Data Model Structures, Data Model Operations, Processing Workloads, Processing in Batch Mode, Processing in Real-time Mode.	6 hrs
5	Big Data Technologies : MongoDB - What is MongoDB? WhyMongoDB? Terms Used in RDBMS and MongoDB, Data Types in MongoDB, MongoDB Query Language.	6 hrs
Unit –III		
6	Big Data Visualization : Hive - What is Hive?, Hive Architecture, Hive Data Types, Hive File Format, Hive Query Language (HQL), RCFfile Implementation, User-Defined Function (UDF).	5 hrs
Text Books:		
2. Thomas Erl, WajidKhattak, and Paul Buhler, Big Data Fundamentals Concepts, Drivers & Techniques, Prentice Hall, 2015.		
3. SeemaAcharya, SubhashiniChellappan, Big Data and Analytics, Wiley India Pvt Ltd 2014.		
Reference Books:		
2. Frank J Ohlhorst, Big Data and Analytics: Turning Big Data into Big Money, Wiley and SAS Business Series, 2012.		
3. Colleen Mccue, Data Mining and Predictive Analysis: Intelligence Gathering and Crime Analysis, Elsevier, 2007.		

Scheme for Semester End Examination (ESA)

UNI T	8 Questions to be set of 20 Marks Each	Chapter Numbers	Instructions
I	Q.No.-1, Q.No.-2, Q.No.-3	1,2,3	Solve Any 2
II	Q.No.-4, Q.No.-5, Q.No.-6	4,5	Solve Any 2
III	Q.No.-7	6	Solve Any 1
	Q.No.-8	6	



FORM
ISO 9001: 2008
School of Computer Science & Engineering

Syllabus copies of the courses highlighting the focus on employability/ entrepreneurship/ skill development

Program: Bachelor of Engineering		
Course Title: Information Security		Course Code: 20ECSC402
L-T-P: 2-0-1	Credits: 3	Contact Hrs: 4 hrs/week
ISA Marks: 50	ESA Marks: 50	Total Marks: 100
Teaching Hrs: 45	Exam Duration: 3 hrs	

Unit –I		
1	Cryptography Basics: Introduction, Classic Crypto: Modern Crypto, Taxonomy of Cryptography and Cryptanalysis. Symmetric Key Crypto: Stream Ciphers, Block Ciphers- AES, DES , IDEA, Block cipher modes, Message Integrity	06 hrs
2	Public Key Crypto and Hash Functions: Introduction, Knapsack, RSA, Diffie-Hellman, Elliptic Curve Cryptography, Uses for Public Key Crypto, Public Key Infrastructure, X.509 Certificates.	06 hrs
Unit –II		
3	Data Integrity Algorithms: Cryptographic Hash Functions: applications and requirements, Hash functions based on cipher block chaining, Secure Hash algorithm, Message authentication codes: requirements and functions, HMAC , Digital Signatures, and Digital Signature Standard.	06hrs
4	Authentication and Authorization: Introduction, Authentication Methods: Passwords, Biometrics, Two-Factor Authentication, Single Sign-On, Protocols. Introduction to authorization , Access Control Matrix, Multilevel Security Models, Multilateral Security, Firewalls, Intrusion Detection	06hrs
Unit –III		
5	Application and Transport Security Protocols: Introduction, Authentication protocols, Secure Socket Layer, IPsec, Kerberos, GSM, Pretty Good Privacy and S/MIME, Transport Layer Security, HTTPs, Kerberos	03 hrs
6	Network and Wireless Security Protocols:IPSec overview, Encapsulating security payload, combining security associations, Internet key exchange, GSM Security, IEEE 802.11 Wireless LAN Security.	03 hrs
Text Books (List of books as mentioned in the approved syllabus)		
<ol style="list-style-type: none"> William Stallings, Cryptography and Network Security Principles And Practices, 7th Edition, Pearson, 2017. Mark Stamp, “Information Security: Principles and Practices”, 2nd Edition, John Wiley and Sons, 2011. 		
References		
<ol style="list-style-type: none"> Michael E. Whitman and Herbert J. Mattord, “Principles of Information Security”, 2nd Edition, Thompson, 2005. Christof Paar Jan Pelzl, “Understanding Cryptography”, Springer-Verlag Berlin Heidelberg 2010 Nigel Poulton, TheKubernetes Book, Packt Publishing, 2019. 		

List of lab Experiments:



FORM
ISO 9001: 2008
School of Computer Science & Engineering

Syllabus copies of the courses highlighting the focus on employability/ entrepreneurship/ skill development

Expt./Job No.	Brief description about the experiment/job	No. of Lab. Slots
9.	Implementation of substitution cipher	1
10.	Demo and practice on Crypto Library	1
11.	Performance analysis of symmetric key algorithm algorithms	2
12.	Performance analysis of asymmetric key algorithm algorithms	2
13.	Performance analysis of Hash algorithms	2
14.	Course project	7

Scheme for End Semester Assessment(ESA)

UNIT	8 Questions to be set of 20 Marks Each	Chapter Numbers	Instructions
I	Q.No.-1, Q.No.-2, Q.No.-3	1, 2	Solve Any 2
II	Q.No.-4, Q.No.-5, Q.No.-6	3, 4	Solve Any 2
III	Q.No.-7, Q.No.-8	5, 6	Solve Any 1



FORM
ISO 9001: 2008
School of Computer Science & Engineering

Syllabus copies of the courses highlighting the focus on employability/ entrepreneurship/ skill development

Program: Bachelor of Engineering			
Course Title: Cyber Security		Course Code: 19ECSE401	
L-T-P: 2-0-1	Credits: 3	Contact Hrs: 2hrs/week	
ISA Marks: 50	ESA Marks: 50	Total Marks: 100	
Teaching Hrs: 30	Exam Duration: 3 hrs		

Unit –I		
1	Introduction to Cybercrime: Cybercrime definition and origins of the world, Cybercrime and information security, Classifications of cybercrime, A global Perspective on cybercrimes. Cyber attack plans, Social Engineering, Cyber stalking, Cyber cafe and Cybercrimes, Botnets, Proliferation of Mobile and Wireless Devices, Credit Card Frauds in Mobile and Wireless Computing Era.	6 hrs
2	Methods used in Cybercrime: Phishing, password Cracking, Key loggers and Spyware, Virus and Worms, Trojan and backdoors, Steganography, DOS and DDOS attack, SQL injection, Buffer Overflow, Identity theft.	6 hrs
Unit –II		
3	Cybercrimes and Cyber security: The Legal Perspectives Why do we need Cyber law: The Indian Context, The Indian IT Act, Digital Signature and the Indian IT Act, Amendments to the Indian IT Act, Cybercrime and Punishment.	6 hrs
4	Cybercrime- Real-Life Examples: Illustrations, Examples and Case studies Introduction, Real-Life Examples, Case Studies: Illustrations of Financial Frauds in Cyber Domain, Digital Signature-Related Crime Scenarios, Online Scams.	6 hrs
Unit –III		
5	Digital Forensics: Historical background of cyber forensic, Forensic analysis of email, Digital forensic life cycle, Network forensic, Setting up a computer forensic Laboratory, Forensic analysis of digital media	6 hrs
Text Books:		
1. Nina Godbole & Sunit Belapure, Cyber Security, Wiley India, 2012		
2. Robert M Slade, Software Forensics, Tata McGraw - Hill, New Delhi, 2005		
Reference Books:		
1. Kevin Mandia, Chris Prosis, Matt Pepe, Incident Response and Computer Forensics, Tata McGraw -Hill, New Delhi, 2006		

Scheme for Semester End Examination (ESA)

UNI T	8 Questions to be set of 20 Marks Each	Chapter Numbers	Instructions
I	Q.No.-1, Q.No.-2, Q.No.-3	1,2	Solve Any 2
II	Q.No.-4, Q.No.-5, Q.No.-6	3,4	Solve Any 2
III	Q.No.-7,8	5	Solve Any 1



FORM
ISO 9001: 2008
School of Computer Science & Engineering

Syllabus copies of the courses highlighting the focus on employability/ entrepreneurship/ skill development

Program: Bachelor of Engineering		
Course Title: Software Testing		Course Code: 18ECSE407
L-T-P: 3-0-0	Credits: 3	Contact Hrs: 03 hrs/week
ISA Marks: 50	ESA Marks: 50	Total Marks: 100
Teaching Hrs: 40	Exam Duration: 3 hrs	

Unit – 1		
1	Software Testing Principles: Need for testing ,The Psychology and Economics of Program Testing Program ,Inspections, Walkthroughs, and Reviews.	04hrs
2	Test-Case Design: Overview, White box testing, Error Guessing, strategies , Module (Unit) Testing-Incremental Testing, Top-down versus Bottom-up Testing, Performing the Test.	06hrs
3	Higher-Order Testing: Function testing, System testing, Acceptance testing, Installation testing, Test planning and Control, Test completion criteria, Extreme testing.	06hrs
Unit – 2		
4	Testing Tools and Standards: Automated Tools for Testing - Static code analyzers - Test case generators - GUI Capture/Playback – Stress Testing - Testing Client – server applications – Testing compilers and language processors - Testing web-enabled applications.	10hrs
5	CMM Model and its stages – Introduction to PCMM, CMMI and Six Sigma concept – ISO 9000.	06hrs
Unit – 3		
6	Software Quality and Testing: Introduction to software quality and quality control – Benefits of quality control - Quality assurance - quality circles and quality improvement.	04hrs
7	Introduction to quality cost – Measuring quality cost – Total Quality Management (TQM).Architecture, Process, memory and file management in Mobile OS, Network OS.	04hrs
Text Books:		
<ol style="list-style-type: none"> Glenford J. Myers, Tom Badgett, Corey Sandler, and Todd M. Thomas, “The Art ofSoftware Testing”, John Wiley & Sons, Second edition, 2004. Roger S. Pressman, “Software Engineering. A Practitioners Approach”, McGraw-HillInternational Edition, Seventh edition, 2009. 		
References:		
<ol style="list-style-type: none"> William E. Perry, “Effective Methods for Software Testing”, John Wiley & Sons, Secondedition, 2000. Boris Beizer, “Techniques for Functional Testing of Software and Systems”, John Wiley & Sons, 1995. P.C. Jorgensen, “Software Testing - A Craftman's Approach”, CRC Press, 1995. Boris Beizer, “Software Testing Techniques”, Van Nostrand Reinhold, Second edition,1990. 		

Scheme for End Semester Assessment(ESA)

UNIT	8 Questions to be set of 20 Marks Each	Chapter Numbers	Instructions
I	Q.No.-1, Q.No.-2, Q.No.-3	1, 2, 3	Solve Any 2
II	Q.No.-4, Q.No.-5, Q.No.-6	4, 5	Solve Any 2
III	Q.No.-7, Q.No.-8	6, 7	Solve Any 1



FORM
ISO 9001: 2008
School of Computer Science & Engineering

Syllabus copies of the courses highlighting the focus on employability/ entrepreneurship/ skill development

Program: Bachelor of Engineering		
Course Title: Social Network Analysis		Course Code: 18ECSE402
L-T-P: 3-0-0	Credits: 3	Contact Hrs: 03 hrs/week
ISA Marks: 50	ESA Marks: 50	Total Marks: 100
Teaching Hrs: 40	Exam Duration: 03 hrs	

Unit –I		
1	Introduction Introduction : Motivation, different sources of network data, types of networks, tools for visualizing network data.	06 hrs
2	Structural properties of networks Structural properties of networks : Notions of centrality, cohesiveness of subgroups, roles and positions, structural equivalence, equitable partitions, stochastic block models.	10 hrs
Unit –II		
3	Cascading properties of networks Cascading properties of networks : Information/influence diffusion on networks, maximizing influence spread, power law and heavy tail distributions, preferential attachment models.	10 hrs
4	Small world phenomenon Small world phenomenon : Six Degrees of Separation, Structure and Randomness, Decentralized Search, Empirical Analysis and Generalized Models, Core-Periphery Structures and Difficulties in Decentralized Search, Advanced Material: Analysis of Decentralized Search.	06 hrs
Unit –III		
5	Mining Graphs- I Mining Graphs- I : Community and cluster detection: random walks.	04 hrs
6	Mining Graphs- II Mining Graphs- II : Spectral methods; link analysis for web mining.	04 hrs
Text Books		
<ol style="list-style-type: none"> Stanley Wasserman, Katherine Faust, Social network analysis: methods and applications, Cambridge University Press, 1994. David Easley and Jon Kleinberg, Networks, Crowds, and Markets: Reasoning About a Highly Connected World., Cambridge University Press, 2010. 		
Reference Books:		
<ol style="list-style-type: none"> Peter R. Monge, Noshir S, Contractor, Theories of communication networks, Oxford University Press, 2003. Duncan Watts, Six degrees: the science of a connected age. Norton, 2004. 		

Scheme for Semester End Examination (ESA)



FORM
ISO 9001: 2008
School of Computer Science & Engineering

Syllabus copies of the courses highlighting the focus on employability/ entrepreneurship/ skill development

UNIT	8 Questions to be set of 20 Marks Each	Chapter numbers	Instructions
I	Q.No.-1, Q.No.-2, Q.No.-3	1, 2	Solve Any 2 out of 3
II	Q.No.-4, Q.No.-5, Q.No.-6	3, 4	Solve Any 2 out of 3
III	Q.No.-7	5	Solve Any 1 out of 2
	Q.No.-8	6	

Program: Bachelor of Engineering		
Course Title: C# Programming and .NET		Course Code: 18ECSE409
L-T-P: 3-0-0	Credits: 3	Contact Hrs: 3hrs/week
ISA Marks: 50	ESA Marks: 50	Total Marks: 100
Teaching Hrs: 40	Exam Duration: 3 hrs	



Syllabus copies of the courses highlighting the focus on employability/ entrepreneurship/ skill development

Unit –I		
1	<p>The Philosophy of .NET Understand the motivation behind the .NET platform, Common Language Infrastructure (CLI). Know the role of the Common Type System (CTS), the Common Language Specification (CLS) and the Common Language Runtime (CLR), Understand the assembly, metadata, namespace, type distinction, Contrast single-file and multi-file assemblies, Know the role of the Common Intermediate Language (CIL), Platform independent .NET(Mono / Portable .NET distributions).</p>	5hrs
2	<p>C# Language Fundamentals Language Fundamentals, Reference and value Types, primitive types the Nullable and enum types, Classes and objects, Defining classes Creating objects, Using static members, Overloading Methods, Various Constructors. Encapsulating data, access modifiers, properties, indexers arrays and readonly fields. Structures. String and DateTime classes, three pillars of OOPs</p>	7 hrs
3	<p>Exceptions and Object Life Time Ode to Errors, Bugs and Exceptions, The Role of .NET Exception handling, the System. Exception base class, Throwing a generic Exception, Catching Exceptions, CLR System-Level Exceptions (System.SystemException), Custom Application-Level Exceptions (System.ApplicationException). Handling Multiple Exception, The Finally Block, The Last Chance Exception, Understanding Object Life time. The CIL of “new”, The Basics of Garbage Collection</p>	4 hrs
Unit –II		
4	<p>Event handling paradigm Interfaces and Collections Understanding the .NET Delegate type, Multicast Delegate and events. Interfaces, overriding interface implementation. Explicit interface implementation, Collection, IEnumerable, IEnumerator, IList, IComparer and their Generic equivalent. Working with generic List, Stack, Dictionary and Queue</p>	6 hrs
5	<p>Programming Window Forms Applications Anatomy of a Form, Component Class, Control Class, Control Events, Responding to Keyboard Events, Form Class, Building Menus with Windows Forms, Building your Menu System, Creating Pop-Up Menu, Adding Controls to Forms (IDE-Free), Adding Controls to Forms (via VS.NET), Working with Basic Controls like Buttons, Configuring Tab Order.</p>	5 hrs
6	<p>Working with Database Introduction to ADO.NET, Connecting to a database, Understanding DataTables, Creating a DataAdapter, Referencing fields in a DataRow, Navigating records, Adding, editing, and deleting records, Building an ADO.NET example.</p>	5 hrs
Unit –III		
7	<p>Understanding the .NET Assemblies Problems with Classic.COM Binaries, An overview of .NET Assembly, Building a single file test assembly, A C# Client Application, A Visual Basic .NET Client Application, Cross-Language Inheritance, Exploring the Car Library’s Manifest, Exploring the Car Library’s Types.</p>	4 hrs
8	<p>Using .NET Assemblies Building a multi file assembly, Using the Multifile Assembly, Understanding the private Assemblies, Probing for private Assemblies (The Basics), Private Assemblies and XML Configuration Files, Probing for Private Assemblies(The details), Understanding Shared Assemblies, Understanding Shared Names, Building a Shared</p>	4 hrs



FORM
ISO 9001: 2008
School of Computer Science & Engineering

Syllabus copies of the courses highlighting the focus on employability/ entrepreneurship/ skill development

Assembly, Understanding Delay Signing, Installing/Removing Shared Assembly, Using a Shared Assembly.
Text Books: 1. Herbert Schildt, "The Complete Reference C# 4.0", Tata McGraw –Hill, 2010 2. Andrew Troelsen, "Pro C# with .NET 3.0", Special Edition, Dream tech Press, India, 2007.
Reference Books: 1. Stephen C. Perry, AtulKahate, Stephen Walther, Joseph Mayo, "Essential of .net and Related Technologies with a focus on C#, XML, ASP.net and ADO.net", 2 nd Edition, Pearson, 2009. 2. Paul J. Deitel, Harvey Deitel, "Visual C# 2010 for Programmers", 4 th Edition, Pearson, 2010. 3. Joseph Albahari and Ben Albhari, "C# 3.0/4.0 in Nutshell", 3 rd Edition, O'Rilley, 2007.

Course Content

Course Code: 20ECSE405	Course Title: Software Defined Networks	
L-T-P : 3-0-0	Credits: 3	Contact Hrs: 40
ISA Marks: 50	ESA Marks: 50	Total Marks: 100
Teaching Hrs: 40		Exam Duration: 3 hrs

Content	Hrs
Unit – 1	
Chapter No. 1.Introduction Evolving network requirements, Types of Network and Internet Traffic, The SDN approach, Data Center Networking: Big Data over SDN, Cloud Networking over SDN.	08 hrs
Chapter No. 2. SDN Data Plane and OpenFlow Data plane functions and protocols, OpenFlow logical network device, OpenFlow protocol, OpenFlow messages, OpenFlow events: Responding to switches.	08 hrs
Unit – 2	
Chapter No. 3.Control Plane SDN Control plane architecture, POX architecture, OpenDaylight architecture, REST, Mininet based examples,	08 hrs
Chapter No. 4.Programming SDNs Components in POX, POX APIs, Registering Components, The Event System: Handling Events, Creating Your Own Event Types, Raising Events, Binding to Components' Events, Working with packets, Working with sockets: ioworker, OpenFlow in POX.	08 hrs
Unit – 3	
Chapter No. 5.Software Application plane SDN Application Plane Architecture , Traffic Engineering, Measurement and Monitoring. Security Requirements, SDN Security.	04hrs
Chapter No. 6.Network Functions Virtualization (NFV) OpenFlow VLAN Support, Virtual Private Networks, Network Virtualization: A Simplified Example, Network Virtualization Architecture, Benefits of Network Virtualization.	04 hrs

Text Books (List of books as mentioned in the approved syllabus)

1. William Stallings, "Foundations of modern networking: SDN, NFV, QoE, IoT and Cloud", Addison Wesley; 1 edition, 2015.
2. Thomas D. Nadeau & Ken Gray, "SDN - Software Defined Networks", O'Reilly, 2013.



FORM
ISO 9001: 2008
School of Computer Science & Engineering

Syllabus copies of the courses highlighting the focus on employability/ entrepreneurship/ skill development

References

3. Sreenivas Voruganti, Sriram Subramanian, "Software-Defined Networking (SDN) with OpenStack", Packt Publishing, 2016.
4. 2. POX manual current documentation, <https://openflow.stanford.edu/display/ONL/POX+Wiki.html>

Program: Bachelor of Engineering		
Course Title: Software Architecture and Design Thinking		Course Code: 18ECSE410
L-T-P: 3-0-0	Credits: 3	Contact Hrs: 3hrs/week
ISA Marks: 50	ESA Marks: 50	Total Marks: 100
Teaching Hrs: 40	Exam Duration: 3 hrs	



Syllabus copies of the courses highlighting the focus on employability/ entrepreneurship/ skill development

Unit –I		
1	What Is Software Architecture? What Software Architecture Is and What It Isn't, Architectural Structures and Views, Architectural Patterns, What Makes a "Good" Architecture?	5 Hrs
2	Why Is Software Architecture Important? Inhibiting or Enabling a System's Quality Attributes, Reasoning About and Managing Change, Predicting System Qualities, Enhancing Communication among Stakeholders, Carrying Early Design Decisions, Defining Constraints on an Implementation, Influencing the Organizational Structure, Enabling Evolutionary Prototyping, Improving Cost and Schedule Estimates, Supplying a Transferable, Reusable Model, Allowing Incorporation of Independently Developed Components, Restricting the Vocabulary of Design Alternatives, Providing a Basis for Training	6 Hrs
3	The Many Contexts of Software Architecture Architecture in a Technical Context, Architecture in a Project Life-Cycle Context, Architecture in a Business Context, Architecture in a Professional Context, Stakeholders, How Is Architecture Influenced? What Do Architectures Influence?	5 Hrs
Unit –II		
4	Understanding Quality Attributes Architecture and Requirements, Functionality, Quality Attribute Considerations, Specifying Quality Attribute Requirements, Achieving Quality Attributes through Tactics, Guiding Quality Design Decisions	5 Hrs
5	Quality Attributes Tactics for Availability, Tactics for Interoperability, Tactics for Modifiability, Tactics for Performance, Tactics for Security, Tactics for Testability, Tactics for Usability,	6 Hrs
6	Architectural Tactics and Patterns Architectural Patterns, Overview of the Patterns Catalog, Relationships between Tactics and Patterns, Using Tactics Together	5 Hrs
Unit –III		
7	Architecture and Requirements Gathering ASRs from Requirements Documents, Gathering ASRs by Interviewing Stakeholders, Gathering ASRs by Understanding the Business Goals, Capturing ASRs in a Utility Tree, Tying the Methods Together	4 hrs
8	Designing an Architecture, Implementation, Testing and Evaluation Designing: Design Strategy, The Attribute-Driven Design Method, The Steps of ADD Implementation, and Testing: Architecture and Implementation, Architecture and Testing Evaluation: Evaluation Factors, The Architecture Tradeoff Analysis Method, Lightweight Architecture Evaluation	4 hrs
Textbooks:		
<ol style="list-style-type: none"> 1. Len Bass, Paul Clements, Rick Kazman, Software Architecture in Practice (3rd Edition), Addison-Wesley Professional; 3 edition 2. Frank Buschmann, Regine Meunier, Hans Rohnert, Peter Sommerlad, Michael Stal: Pattern- Oriented Software Architecture, A System of Patterns, Volume 1, John Wiley and Sons, 2012 (chapter 2) 		
Reference Books:		
<ol style="list-style-type: none"> 1. Richard N. Taylor, Nenad Medvidovic and Eric M. Dashofy: Software Architecture: Foundations, Theory, and Practice, Wiley- India 2012 2. Mary Shaw and David Garlan: Software Architecture-Perspectives on an Emerging Discipline, Prentice Hall of India, 2007 		



FORM
ISO 9001: 2008
School of Computer Science & Engineering

Syllabus copies of the courses highlighting the focus on employability/ entrepreneurship/ skill development

Scheme for Semester End Examination (ESA)

UNIT	8 Questions to be set of 20 Marks Each	Chapter Numbers	Instructions
I	Q.No.-1, Q.No.-2, Q.No.-3	1,2	Solve Any 2
II	Q.No.-4, Q.No.-5, Q.No.-6	3,4	Solve Any 2
III	Q.No.-7	5	Solve Any 1
	Q.No.-8	6	



Syllabus copies of the courses highlighting the focus on employability/ entrepreneurship/ skill development

Course Content

Program: Bachelor of Engineering		
Course Title: Senior Design Project		Course Code: 20ECSW401
L-T-P: 0-0-6	Credits: 6	Contact Hrs: 3 hrs/week
ISA Marks: 50	ESA Marks: 50	Total Marks: 100
Teaching Hrs: 39	Exam Duration: 3hrs	

Seventh semester senior design project theme: Usage of Design Principles in building the solution.

SDP aims to design and develop a solution using software design principles:- design patterns (creational, behavioral & structural) , User experience (UX) design and API (application programming interface) that are generally followed in industries.

Project domains:

Networking	Data Engineering	System Engineering
<ul style="list-style-type: none"> ● Internet of Things ● Cloud Computing ● SDN(Software Defined Network) ● SNA(Social Network Analysis) 	<ul style="list-style-type: none"> ● Data Analytics <p><i>Data Processing:</i></p> <ul style="list-style-type: none"> ● Image and video processing ● Computer Vision and Graphics ● NLP(Natural Language Processing) 	<ul style="list-style-type: none"> ● Parallel Computing ● HPC(High Performance Computing) ● Parallel system design

Student Evaluation Matrix:

Project will have 3 internal reviews as follows:

Continuous internal Evaluation	Review Expectation
Review-1	Literature Survey, Problem Analysis and Problem formulation
Review-2	Requirements, Design, design principles adopted in modules/components and Algorithms.
Review-3	Implementation and Testing.



FORM
ISO 9001: 2008
School of Computer Science & Engineering

Syllabus copies of the courses highlighting the focus on employability/ entrepreneurship/ skill development

Scheme for End Semester Assessment (ESA)

Sl.No	Expectation	Marks
1	Write up 5. Problem Statement and Objectives. 6. System design with brief description. 7. Concluding remarks.	05
2	Presentation: Prepare minimum of 15-18 slides of presentation with consultation of your respective guides.	05
3	Demo (Complete execution of the project with results) and Viva voce.	30
4.	Project Report.	10



8thSem Elective List

Program: Bachelor of Engineering		
Course Title: Natural Language Processing		Course Code: 18ECSE403
L-T-P: 2-0-1	Credits: 3	Contact Hrs: 04 hrs/week
ISA Marks: 50	ESA Marks: 50	Total Marks: 100
Teaching Hrs: 30	Exam Duration: 3 hrs	

Unit –I		
1	Introduction to NLP and Deep Learning Introduction to Natural Language Processing, Applications of Natural Language Processing, Word2vec introduction, Word2vec objective function gradients	5 hrs
2	Dependency Parsing, Recurrent Neural Networks Dependency Grammar , Neural dependency parsing, Recurrent Neural Networks and Language Models, Vanishing Gradients, Fancy RNNs	7 hrs
Unit –II		
3	Machine Translation, Seq2Seq and Attention Machine Translation, Seq2Seq and Attention, Advanced Attention	6 hrs
4	Transformer Networks , Coreference Resolution, Memory Networks Transformer Networks and CNNs, Tree Recursive Neural Networks and Constituency Parsing , Advanced Architectures and Memory Networks	6 hrs
Unit –III		
5	Reinforcement Learning Reinforcement Learning for NLP, Semi-supervised Learning for NLP, Future of NLP Models, Multi-task Learning and QA Systems	6 hrs
Text Books: 1. Yoav Goldberg. A Primer on Neural Network Models for Natural Language Processing , 2016.		
Reference Books: Dan Jurafsky and James H. Martin. Speech and Language Processing 3Ed. Draft. Ian Goodfellow, YoshuaBengio, and Aaron Courville. <i>Deep Learning</i> . MIT Press.		

List of experiments

Expt./Job No.	Brief description about the experiments	No. of Lab slots per batch (2 hrs)
1.	Installation of nltk tool kit in python and practicing of word tokenization, spellchecker programs.	1
2.	Compute softmax points (probabilities) for numerical stability.	1
3.	Implement the word2vec model for word vector representation.	1
4.	Implement the dependency parsing for the following sentence “I parsed this sentence correctly” and show at least three steps for parsing with stack and buffer status.	2
5.	Write a program to build seq2seq sentence from word corpora(Tensorflow).	1
6.	Implement the neural image caption generator.	2
7.	Implement question answering (QA) system, to answer the questions posed in natural language.	1



FORM
ISO 9001: 2008
School of Computer Science & Engineering

Syllabus copies of the courses highlighting the focus on employability/ entrepreneurship/ skill development

Scheme for End Semester Assessment(ESA)

UNIT	8 Questions to be set of 20 Marks Each	Chapter Numbers	Instructions
I	Q.No.-1, Q.No.-2, Q.No.-3	1, 2	Solve Any 2
II	Q.No.-4, Q.No.-5, Q.No.-6	4,5	Solve Any 2
III	Q.No.-7	6	Solve Any 1
	Q.No.-8		

Program: Bachelor of Engineering		
Course Title: Big Data Analytics		Course Code: 18ECSO401
L-T-P: 3-0-0	Credits: 3	Contact Hrs: 3hrs/week
ISA Marks: 50	ESA Marks: 50	Total Marks: 100
Teaching Hrs: 40	Exam Duration: 3 hrs	

Unit –I		
1	Introduction: Data Analytics, Data Analytics Life Cycle, Big Data Characteristics, Different Types of Data.	4hrs
2	Big Data Technologies: Parallel Data Processing, Distributed Data Processing, Hadoop , Spark	8hrs
3	Nosql: NoSQL Databases, Document databases, Key-value databases, Wide-column stores, Graph databases	4 hrs
Unit –II		
4	Big Data Modeling: Data Model Structures, Data Model Operations, Processing Workloads, Processing in Batch Mode, Processing in Real-time Mode.	8 hrs
5	MongoDB – Introduction to MongoDB, RDBMS and MongoDB, Data Types in MongoDB, MongoDB Query Language.	8 hrs
Unit –III		
6	Big Data Visualization: Hive - Hive Architecture, Hive Data Types, Hive File Format, Hive Query Language (HQL).	4 hrs
7	Big data applications and case study : Stock market analysis, weather data analysis	4 hrs
Text Books:		
3. Thomas Erl, WajidKhattak,and Paul Buhler, Big Data Fundamentals Concepts, Drivers & Techniques, Prentice Hall, 2015.		
4. SeemaAcharya, SubhashiniChellappan, Big Data and Analytics, Wiley India Pvt Ltd 2014		
Reference Books:		
4. Frank J Ohlhorst, Big Data and Analytics: Turning Big Data into Big Money, Wiley and SAS Business Series, 2012.		
5. Colleen Mccue, Data Mining and Predictive Analysis: Intelligence Gathering and Crime Analysis, Elsevier, 2007.		



Syllabus copies of the courses highlighting the focus on employability/ entrepreneurship/ skill development

Scheme for End Semester Assessment (ESA)

UNIT	8 Questions to be set of 20 Marks Each	Chapter Numbers	Instructions
I	Q.No.-1, Q.No.-2, Q.No.-3	1, 2,3	Solve Any 2 out of 3
II	Q.No.-4, Q.No.-5, Q.No.-6	4,5	Solve Any 2 out of 3
III	Q.No.-7	6	Solve Any 1 out of 2
	Q.No.-8	7	



Syllabus copies of the courses highlighting the focus on employability/ entrepreneurship/ skill development

Program: Bachelor of Engineering		
Course Title: Advanced Parallel Computing		Course Code: 18ECSE408
L-T-P: 3-0-0	Credits: 3	Contact Hrs: 03 hrs/week
CIE Marks: 50	SEE Marks: 50	Total Marks: 100
Teaching Hrs: 40	Exam Duration: 3 hrs	

Unit –I		
1	Introduction and History GPUs as Parallel Computers; Architecture of a Modern GPU; Parallel Programming Languages and Models; Overarching Goals; Evolution of Graphics Pipelines; The Era of Fixed- Function ; Graphics Pipelines; Evolution of Programmable Real-Time Graphics; Unified Graphics and Computing Processors; GPGPU; An Intermediate Step; GPU Computing; Scalable GPUs Recent Developments; Future Trends.	07 hrs
2	Introduction to CUDA Data Parallelism; CUDA Program Structure; A Matrix-Matrix Multiplication Example; Device Memories and Data Transfer; Kernel Functions and Threading; Function declarations; Kernel launch; Predefined variables; Runtime API.CUDA Thread Organization; Using block Id x and thread Id x ; Synchronization and Transparent Scalability; Thread Assignment ; Thread Scheduling and Latency Tolerance.	09 hrs
Unit –II		
3	CUDA Memories Importance of Memory Access Efficiency; CUDA Device Memory Types; A Strategy for Reducing Global Memory Traffic; Memory as a Limiting Factor to Parallelism; Global Memory Bandwidth; Dynamic Partitioning of SM Resources; Data Perfetching; Instruction Mix; Thread Granularity; Measured Performance.	07 hrs
4	Introduction to OPENCL Introduction to OPENCL; Background; Data Parallelism Model; Device Architecture; Kernel Functions; Device Management and Kernel Launch; Electrostatic Potential Map in OpenCL.	09 hrs
Unit –III		
5.	Case Study Concepts of Game Design, Applications like Matrix multiplication, MRI reconstruction Molecular Visualization and Gaming.	04 hrs
6.	Parallel Programming and Computational Thinking Goals of Parallel Programming, Problem Decomposition, Algorithm Selection, Computational Thinking.	04 hrs
Text Books:		
1. David B. Kirk, Wen-mei W. Hwu, “Programming Massively Parallel Processors: A Hands on Approach”, Morgan Kaufmann/Elsevier India reprint, 2010.		
Reference Books:		
1. Benedict R Gaster, Lee Howes, David Kaeli, Perhaad Mistry and Dana Schaa, “Heterogeneous Computing with OpenCL”, Morgan Kaufmann/Elsevier reprint, 2012.		



FORM
ISO 9001: 2008
School of Computer Science & Engineering

Syllabus copies of the courses highlighting the focus on employability/ entrepreneurship/ skill development

Scheme for End Semester Assessment(ESA)

UNIT	8 Questions to be set of 20 Marks Each	Chapter Numbers	Instructions
I	Q.No.-1, Q.No.-2, Q.No.-3	1, 2	Solve Any 2
II	Q.No.-4, Q.No.-5, Q.No.-6	3,4	Solve Any 2
III	Q.No.-7	5	Solve Any 1
	Q.No.-8	6	



FORM
ISO 9001: 2008
School of Computer Science & Engineering

Syllabus copies of the courses highlighting the focus on employability/ entrepreneurship/ skill development

Program: Bachelor of Engineering		
Course Title: Model Thinking		Course Code: 18ECSE411
L-T-P: 3-0-0	Credits: 3	Contact Hrs: 40 hrs
ISA Marks: 50	ESA Marks: 50	Total Marks: 100
Teaching Hrs: 40 hrs	Exam Duration: 03 hrs	

Unit –I		
1	Why Model Model Thinking - The Need, Advantages and Disadvantages, Segregation/Peer Effects, Case Study	4 hrs
2	Modeling People, Tipping Points & Economic Growth Rational Models, Behavioral Models, Rule Based Models, Percolation Models, Growth and its Kinds	6 hrs
3	Special Topics Standing Ovation Model, Game of Life, Lyapunov Functions: Equilibrium, A cycle, Randomness or Complexity, Coordination and Culture, Urn Models, Polya Process, Paths and Networks, Prisoners' Dilemma, Collective Action & Mechanism Design	6 hrs
Unit –II		
4	Randomness and Learning Models Luck as Randomness, Random Walks & Colonel Blotto, Replicator Dynamics, Fisher's Fundamental Theorem, Prediction and the Many Model Thinker, Social Models	8 hrs
5	Model Checking and Modelling Concurrent Systems Model Checking, Characteristics of Model Checking, Transition Systems, Parallelism and Communication, The State Space Explosion	8 hrs
Unit –III		
6	Linear-Time Properties Linear-Time Behavior, Safety Properties and Invariants, Liveness Properties, Fairness	4 hrs
7	Regular Properties Automata on Finite Words, Model-Checking Regular Safety Properties, Automata on Infinite Words, Model Checking with Omega-Regular Properties	4 hrs
Text Books:		
<ol style="list-style-type: none"> 1. Scott E Page, The Model Thinker, Basic Books Publication, 2018. 2. Christel Baier and Joost-Pieter Katoen, Principles of Model Checking (Representation and Mind Series), The MIT Press, 2008. 		
Reference Books:		
<ol style="list-style-type: none"> 1. Model Thinking Coursera online course from Michigan University. 		

Scheme for End Semester Assessment (ESA)

UNIT	8 Questions to be set of 20 Marks Each	Chapter Numbers	Instructions
I	Q.No.-1, Q.No.-2, Q.No.-3	1, 2,3	Solve Any 2
II	Q.No.-4, Q.No.-5, Q.No.-6	4,5	Solve Any 2
III	Q.No.-7	6	Solve Any 1
	Q.No.-8	7	



FORM
ISO 9001: 2008
School of Computer Science & Engineering

Syllabus copies of the courses highlighting the focus on employability/ entrepreneurship/ skill development



Syllabus copies of the courses highlighting the focus on employability/ entrepreneurship/ skill development

Program: Bachelor of Engineering		
Course Title: Essential of IT		Course Code: 15EC SO405
L-T-P: 3-0-0	Credits: 3	Contact Hrs: 40 hrs
ISA Marks: 50	ESA Marks: 50	Total Marks: 100
Teaching Hrs: 40 hrs	Exam Duration: 03 hrs	
Unit –I		
1	Introduction to computer systems: Components of computer systems, program execution cycle, computer networks, software and its classification, Operating System: introduction, memory management, process management, file management.	06 hrs
2	Programming basics: Introduction to problem solving, SDLC overview and need for object oriented approach, object oriented concepts, introduction to java, control structures, arrays, strings.	06 hrs
3	Classes and Objects: Class fundamentals, access specifiers, constructors and its types, method overloading, static members.	04 hrs
Unit –II		
4	Data structures: Introduction, Linear data structures: stack, queue, linked lists, Non-Linear data structures: trees, binary search tree, illustration using java collection framework.	05 hrs
5	Inheritance and Polymorphism: Inheritance: basics, types of inheritance, method overloading and overriding, dynamic method dispatch.	05 hrs
6	Packages, Interfaces and Exceptions: Introduction to packages, access protection, interfaces, exception handling mechanism, and user defined exceptions.	06 hrs
Unit –III		
7	Database Design Process: Characteristics of DBMS, ER model, mapping ER model to relational schema, normalization.	04 hrs
8	Structured Query Language: SQL data types, database languages, operators, aggregate functions, order by and group by clause, joins and sub queries.	04 hrs
Text Books: 1. Infosys Campus Connect Foundation Program Volume:1–3, Education and Research Department, Infosys Technologies Ltd, 2013. 2. Herbert Schildt, “Java The Complete Reference”, 8th Edition, McGraw-Hill, 2012.		
Reference Books: 1. Elmasri. and Navathe, “Fundamentals of Database Systems”, 6th Edition, Pearson Education, 2011. 2. Silberschatz, Galvin, and Gagne, "Operating System Concepts", 8th Edition, Wiley, 2009.		



Syllabus copies of the courses highlighting the focus on employability/ entrepreneurship/ skill development

Scheme for End Semester Assessment (ESA)

UNIT	8 Questions to be set of 20 Marks Each	Chapter Numbers	Instructions
I	Q.No.-1, Q.No.-2, Q.No.-3	1, 2,3	Solve Any 2
II	Q.No.-4, Q.No.-5, Q.No.-6	4,5	Solve Any 2
III	Q.No.-7	6	Solve Any 1
	Q.No.-8	7	



FORM
ISO 9001: 2008
School of Computer Science & Engineering

Syllabus copies of the courses highlighting the focus on employability/ entrepreneurship/ skill development

Program: Bachelor of Engineering		
Course Title: Software Engineering		Course Code: 15EC SO403
L-T-P: 3-0-0	Credits: 3	Contact Hrs: 3hrs/week
ISA Marks: 50	ESA Marks: 50	Total Marks: 100
Teaching Hrs: 40	Exam Duration: 3 hrs	

Unit –I		
1	Software Engineering process Professional software development, Software engineering ethics, Case studies, Software processes: Software process models, Process activities, Coping with change, The rational unified process, Continuous Integration and Continuous Deployment and Tools.	6hrs
2	Agile Software Development Agile methods, Plan-driven and agile development, Extreme programming, Agile project management.	4 hrs
3	Requirement Engineering Functional and Non-functional requirements; The software requirements Document, Requirement specification, Requirements Engineering Processes, Requirement’s elicitation and analysis; Requirements validation; Requirements management.	6 hrs
Unit –II		
4	System Modeling Context models, Interaction Models, Structural models, Behavioral models.	6 hrs
5	Architectural Design Architectural Design Decision, Architectural views, Architectural patterns, Application Architectures.	5 hrs
6	Object-Oriented design and implementation Object oriented design using UML, design patterns, Implementation Issues, Open source development.	5 hrs
Unit –III		
7	Software Testing Development Testing, Test Driven Development, Release Testing, User Testing.	4 hrs
8	Configuration management Change management, Version management, System building, Release management.	4 hrs
Text Books: 1. Ian Somerville, Software Engineering, 9th, Pearson Ed, 2015		
Reference Books: 1. Roger S. Pressman, Software Engineering: A Practitioners Approach, 7th, McGraw,2007 2. Shari Lawrence Pfleeger and Joanne M. Atlee, Software Engineering Theory and Practice, 3rd, Pearson Ed, 2006 3. Jalote, P, An Integrated Approach to Software Engineering, 3rd, Narosa Pub, 2005		

Scheme for End Semester Assessment (ESA)

UNIT	8 Questions to be set of 20 Marks Each	Chapter Numbers	Instructions
I	Q.No.-1, Q.No.-2, Q.No.-3	1, 2,3	Solve Any 2 out of 3
II	Q.No.-4, Q.No.-5, Q.No.-6	4,5,6	Solve Any 2 out of 3
III	Q.No.-7	7	Solve Any 1 out of 2
	Q.No.-8	8	



FORM
ISO 9001: 2008
School of Computer Science & Engineering

Syllabus copies of the courses highlighting the focus on employability/ entrepreneurship/ skill development



FORM
ISO 9001: 2008
School of Computer Science & Engineering

Syllabus copies of the courses highlighting the focus on employability/ entrepreneurship/ skill development

Program: Bachelor of Engineering		
Course Title: Industry Project		Course Code: 20ECSW494
Credits: 11	ISA Marks: 50	ESA Marks: 50
Total Marks: 100	Exam Duration: 3 hrs	L-T-P: 0-0-11

Overview of the Course
<p>The purpose of providing the Industry Project is to give you the opportunity for students, to apply the knowledge, skills and competencies they have acquired, in real life practice. An Industry Project involves a stay in a relevant company or organization.</p>
<p>The students who got placed in campus interviews may be offered Industry Project depending upon the need of the company. Other students who wish to do Industry Project are responsible to find a company on their own.</p>

Scheme for In Semester Assessment (ISA) and End Semester Assessment (ESA)

Course	Course Code	Max ISA marks	Max ESA marks	Minimum Passing Marks
Industry Project	18ECSW494	50	50	Students must secure minimum of 40% marks in both ISA and ESA.

Parameter	Marks
Write Up	10
Presentation	10
Project demo	25
Report	05
Total Marks	50

ESA Evaluation Parameters

	FORM ISO 9001: 2008 School of Computer Science & Engineering	
	Syllabus copies of the courses highlighting the focus on employability/ entrepreneurship/ skill development	

	FORM ISO 9001: 2008 Department of Computer Science & Engineering	Document #: FMCD2005	Rev: 1.0
	Curriculum Content- Course wise		Year: 2017-21

Program: Bachelor of Engineering		
Course Title: Industry Training		Course Code: 18ECSI493
Credits: 6	ISA Marks: 50	ESA Marks: 50
Total Marks: 100	Exam Duration: 3 hrs	L-T-P: 0-0-6

Overview of the Course: <p>Industry Training is a supervised, practical training periods for which Undergraduate, final year students earn academic credits. Industry Training provide excellent opportunities for students to put into practice much of the knowledge and skills acquired during their studies and to gain firsthand knowledge of the software industry. It is also an opportunity for employers to observe the student in the work environment and evaluate their potential for possible future employment.</p> <p>The companies selected for the Industry Training can range from start-ups to large scale industries. The students who got placed in campus interviews may be offered Industry Training depending upon the need of the company. Other students who wish to do internship are responsible to find a company on their own for the Training.</p>

Scheme for In Semester Assessment (ISA) and End Semester Assessment (ESA)

Course	Course Code	Max ISA marks	Max ESA marks	Minimum Passing Marks
Industry Training	18ECSI493	50	50	Students must secure minimum of 40% marks in both ISA and ESA.

ESA Evaluation Parameters

Parameter	Marks
Write Up	10
Presentation	10
Skills learned (Development, Testing)	25
Report	05



Course Content

Program: Bachelor of Engineering		
Course Title: Capstone Project		Course Code: 20ECSW401
L-T-P: 0-0-11	Credits: 11	Contact Hrs: 3 hrs/week
ISA Marks: 80	ESA Marks: 20	Total Marks: 100
Teaching Hrs: 45	Exam Duration: 3hrs	

Eight semester Capstone project theme: Usage of Design Principles in building the solution.

CP aims to design and develop a solution using software design principles:- design patterns (creational, behavioral & structural) , User experience (UX) design and API (application programming interface) that are generally followed in industries.

Project domains:

Networking	Data Engineering	System Engineering
<ul style="list-style-type: none"> • Internet of Things • Cloud Computing • SDN(Software Defined Network) • SNA(Social Network Analysis) 	<ul style="list-style-type: none"> • Data Analytics <p><i>Data Processing:</i></p> <ul style="list-style-type: none"> • Image and video processing • Computer Vision and Graphics • NLP(Natural Language Processing) 	<ul style="list-style-type: none"> • Parallel Computing • HPC(High Performance Computing) • Parallel system design

Student Evaluation Matrix:

Project will have 3 internal reviews as follows:

Continuous internal Evaluation	Review Expectation
Review-1	Literature Survey, Problem Analysis and Problem formulation
Review-2	Requirements, Design, design principles adopted in modules/components and Algorithms.
Review-3	Implementation and Testing.

Scheme for End Semester Assessment (ESA)

Sl.No	Expectation	Marks
1	Project demonstration	10
2	Results and Discussions	05



FORM
ISO 9001: 2008
School of Computer Science & Engineering

Syllabus copies of the courses highlighting the focus on employability/ entrepreneurship/ skill development

3	Relevance of project to ethical/ social/ legal/ economic concerns	05

Program: Bachelor of Engineering		
Course Title: Blockchain and Distributed Ledgers		Course Code:21ECSC307
L-T-P: 2-0-1	Credits: 3	Contact Hrs: 4 hrs/week
ISA Marks: 50	ESA Marks: 50	Total Marks: 100
Teaching Hrs: 30	Exam Duration: 3 hrs	

Unit –I		
1	Introduction Overview of blockchain, Digital Money to Distributed Ledgers, Design Primitives: Protocols, Security, Consensus, Permissions, Privacy, Types of blockchain, blockchain platforms, Blockchain Architecture and use cases, Introduction to Bitcoin, Bitcoin transactions and scripts	6 hrs
2	Cryptography Basics Introduction to cryptography, Public key crypto: Introduction, RSA, Digital certificate, PKI, Hash Functions: Introduction, SHA, Digital signature Schemes: RSA, Digital Signature Standard, Merkle trees.	6 hrs
Unit –II		
3	Consensus Mechanisms Basic consensus mechanisms, Requirements for the consensus protocols, Proof of Work, Proof of State, Proof of Activity, Practical Byzantine Fault Tolerance (PBFT), Federated PBFT, Consensus protocols in Blockchain platforms, Scalability issues of consensus protocols.	6 hrs
4	Blockchain Platforms Ethereum transactions, accounts, smart contracts, smart contract development, Solidity basics, basic contracts, distributed storage and IPFS, Ethereum scaling, architecture and components of Hyperledger, Fabric membership and identity management, chaincode as a smart contract	6 hrs
Unit –III		
5	Blockchain Applications Blockchain in Financial Software and Systems: Settlements, KYC, Insurance Government: Digital identity, land records, public distribution system, social welfare systems, Blockchain for cyber security: Cloud forensics, Identity management, Intrusion detection.	6 hrs
Reference Books:		
<ol style="list-style-type: none"> Narayanan, Bonneau, Felten, Miller and Goldfeder, “Bitcoin and Cryptocurrency Technologies: A Comprehensive Introduction”, Princeton University Press, 2016. Rogen Wattenhofer, “Blockchain Science : Distributed Ledger Technologies”, 1st Edition, Inverted Forest Publishing, 2019 		



FORM
ISO 9001: 2008
School of Computer Science & Engineering

Syllabus copies of the courses highlighting the focus on employability/ entrepreneurship/ skill development

3. Andreas A, Gavin Wood, "Mastering Ethereum: Building smart contracts and DApp", 1st Edition, O'Reilly Media, 2018.
4. Matt Zand, Xun Wu, Mark Anthony Morris, "Hands-On Smart Contract Development with Hyperledger Fabric V2", 1st Edition, O'Reilly Media, 2018.

Program: Bachelor of Engineering		
Course Title: Web Technologies Lab		Course Code: 21ECSP304
L-T-P: 0-0-2	Credits: 2	Contact Hrs: 4hrs/week
ISA Marks: 80	ESA Marks: 20	Total Marks: 100
Teaching Hrs: 30	Exam Duration: 3 hrs	

1	Introduction to HTML basics, JavaScript Introduction to World Wide Web, Web Application Architecture, HTML Basics, Cascading Style Sheets, JavaScript Basics	4 hrs
2	RESTful API using NodeJS and Express Introduction to Node.js .Building servers using the http and net modules, Node modules and events, Express, REST API client, Postman, Accessing Data, Data Security using Bcrypt. API security using JWT tokens.	12 hrs
3	Angular Building blocks of Angular Apps, Components, Templates, Directives. Services, Dependency injection, Bindings, observables, pipes, component communications, Forms, Interacting with servers using HTTP. RouteGuard, Interceptors, Bundling and deploying applications, Hosting	12 hrs
4	React JSX, React Components, Interaction of Components, Lifecycle methods, Form.	8 hrs
Reference Books:		
<ol style="list-style-type: none"> 5. Robert W. Sebesta."Programming the World Wide Web", Pearson Publications 8th Edition, 2014. 6. Nathan Murray, Felipe Coury, et al, "ng-book: The Complete Guide to Angular", FullStack.io Publications, 2019 7. AzatMardan, "Practical Node.js: Building Real-World Scalable Web Apps", 2nd Edition Apress, 2018. 8. Den Ward, "React Native Cookbook: Recipes for solving common React Native development problems". 2nd Edition,2019 		

Lab Plan

Expt./ Job No.	Lab assignments/experiment	Slots
1	Demonstration on HTML, JavaScript	02
2	Exercise on JavaScript	01



FORM
ISO 9001: 2008
School of Computer Science & Engineering

Syllabus copies of the courses highlighting the focus on employability/ entrepreneurship/ skill development

3	Demonstration on Node	03
4	Exercise on Node	01
5	Demonstration on Angular	02
6	Exercise on Angular	01
7	Demonstration on React	02
8	Exercise on React	01
9	Structured enquiry 1 – MEAN	02
10	Structured enquiry 2 – React	02

 KLE Technological University Creating Value Leveraging Knowledge	FORM ISO 9001: 2008	Document #: FMCD2005	Rev: 1.0
	Department of Electrical & Electronics Engineering		
	Syllabus		

Course Code: 19EEEC201

Course Title: Circuit Analysis

L-T-P-SS: 4-0-0

Credits: 4

Contact Hrs: 50

CIE Marks: 50

SEE Marks: 50

Total Marks: 100

Teaching Hrs: 50

Exam Duration: 3 hrs

Chapter No.	Unit-I	Hrs
1	Network Equations :Source Transformation, Star Delta transformation, Nodal Analysis, Super node, Mesh Analysis, Super mesh, Duality, Network Topology, Tie Set and Cut Set matrix formulation, Dot convention.	8 hrs
2	Network Theorems :Homogeneity, Superposition and Linearity, Thevenin's & Norton's Theorems, Maximum Power Transfer Theorem, Milman's theorem, Reciprocity principle, Application of theorems to both ac and dc networks	8 hrs
3	Two Port Networks :Two port variables, Z, Y, H, G, A- Parameter representations, Input and output impedance calculation, Series, Parallel and Cascade network connections, and their (suitable) models.	4 hrs
Unit-II		
4	First order circuits :Order of a system, Concept of Time constant, System Governing equation, System Characteristic equation, Basic RL & RC circuit, Transient response with initial conditions , Frequency response characteristics, R-C , R-L circuits as differentiator and integrator models, time and frequency domain responses R-C , R-L circuits as Low pass and high pass filters	8 hrs
5	Higher order circuits: Higher order R-C, R-L, and R-L-C networks, time domain and frequency domain representation, Series R-L-C circuit, Transient response, Damping factor, Quality factor, Frequency response curve , Peaking of frequency curve and its relation to damping factor, Resonance Parallel, R-L-C circuit, Tank circuit, Resonance, Quality factor and Bandwidth	12 hrs
Unit-III		
6	Sinusoidal Steady state analysis : Characteristics of sinusoids, Forced response to sinusoidal functions, The complex forcing function, Phasors & Phasor diagrams.	5 hrs
7	Polyphase Circuits : Polyphase systems, Single Phase three wire system, Three phase Y-Y connection, Delta connection, Analysis of balanced & unbalanced three phase circuits.	5 hrs

Text Books

- 1 W H Hayt, J E Kemmerly, S M Durban, Engineering Circuit Analysis, 6th, McGraw Hil, 2006
- 2 M E. Van Valkenburg, Network Analysis, 3rd, Pearson Ed, 2006

Reference Books:

- 1 Joseph Edminister, Mahmood Nahavi, Electric Circuits, 3rd, Tata McGraw, 1991
- 2 Bruce Carlson, Circuits, 3rd, Thomson Le, 2002
- 3 V. K. Aatre, Network Theory and Filter Design, 2nd, Wiley West, 2002
- 4 Anant Agarwal and Jeffrey H Lang, Foundations of Analog & Digital Electronics Circuits, 3rd, Morgan Kaufmann, 2006
- 5 Muhammad H . Rashid, Introduction to PSPICE using OrCAD for circuits and Electronics, 3rd, Pearson Ed, 2005

 KLE Technological University Creating Value Leveraging Knowledge	FORM ISO 9001: 2008	Document #: FMCD2005	Rev: 1.0
	Department of Electrical & Electronics Engineering		
	Syllabus		

Course Title: Analog Electronic Circuits

Course Code:15EEEC202

L-T-P-SS: 4-0-0

Credits: 4

Contact Hours: 4Hrs/week

CIE Marks: 50

SEE Marks: 50

Total Marks: 100

Teaching Hours: 50Hrs

Examination Duration: 3Hrs

Unit I	
Chapter 1: Applications of a Junction diode: Recap of piece-wise linear model, constant voltage drop model, ideal diode model, small signal model. Applications of diodes as a Clipping circuit and clamping circuits Voltage doubler.	06Hrs
Chapter 2: MOSFETs structure and physical operation: Device structure, operation with no gate voltage, creating a channel for current flow, applying small vds, operation as vds is increased, derivation of the id-vds relationship, the P-channel mosfet, complementary mos or cmos, operating the mos transistor in the sub threshold region. Current-voltage characteristics: circuit symbol, the id vs vds characteristics, finite output resistance in saturation, characteristics of the p-channel mosfet, the role of the substrate-the body effect, temperature effects, breakdown and input protection. MOSFET circuits at DC.	12 Hrs
Unit II	
Chapter 3:Current mirrors Basic current mirror, Widlar, Cascode and Wilson : Output impedance and Voltage swing.	08 Hrs
Chapter 4: MOSFET amplifiers : Biasing in MOS amplifier circuits, small signal operation and models, single stage mos amplifiers, the MOSFET internal capacitance and high frequency model, frequency response of CS amplifier.(CD and CG), Cascode Connection: Implications on gain and Bandwidth	12 Hrs
Unit III	
Chapter 5: Feedback Amplifiers : General feedback structure (Block schematic), Feedback desensitivity factor, positive and negative feedback Nyquist stability Criterion, RC phase shift oscillator, wein bridge oscillator, merits of negative feedback, feedback topologies: series-shunt feedback amplifier, series-series feedback amplifier, and shunt-shunt and shunt-series feedback amplifier with examples	06 Hrs
Chapter 6: Large Signal Amplifiers : Classification of amplifiers: (A, B, AB and C); Transformer coupled amplifier, push-pull amplifier Transistor case and heat sink.	06 Hrs

Text Books

1. A.S. Sedra & K.C. Smith, "Microelectronic Circuits", 5th Edition, Oxford Univ. Press, 1999.
2. Jacob Millman and Christos Halkias, "Integrated Electronics", McGraw Hill,

References

1. David A. Bell, "Electronic Devices and Circuits" 4thedition , PHI publication 2007.
2. Grey, Hurst, Lewis and Meyer, "Analysis and design of analog integrated circuits," 4thedition.
3. Thomas L. Floyd, "Electronic devices", Pearson Education, 2002
4. Richard R. Spencer & Mohammed S. Ghousi, " Introduction to Electronic Circuit Design", Pearson Education, 2003
5. J. Millman & A. Grabel, "Microelectronics"-2nd edition, McGraw Hill, 1987.
6. Behzad Razavi, "Fundamentals of Microelectronics", reprint 2015 Wiley publications.

 KLE Technological University Creating Value Leveraging Knowledge	FORM ISO 9001: 2008	Document #: FMCD2005	Rev: 1.0			
				Department of Electrical & Electronics Engineering		
				Syllabus		

Course Code: 19EEEC203

Course Title: Digital Circuits

L-T-P-Self Study: 4-0-0

Credits: 4

Contact Hrs: 50

ISA Marks: 50

ESA Marks: 50

Total Marks: 100

Teaching Hrs: 50

Exam Duration: 3 hrs

Content	Hrs
Unit – 1	
Chapter No. 1. Logic Families Logic levels, output switching times, fan-in and fan-out, comparison of logic families	2 hrs
Chapter No. 2. Principles of Combinational Logic Definition of combinational logic, canonical forms, Generation of switching equations from truth tables, Karnaugh maps-3,4 variables, Incompletely specified functions(Don't care terms), Simplifying Maxterm equations, Quine-McCluskey minimization technique- QuineMcCluskey using don't care terms, Reduced Prime Implicant Tables.	8 hrs
Chapter No. 3. Analysis and design of combinational logic General approach, Decoders-BCD decoders, Encoders, Digital multiplexers- Using multiplexers as Boolean function generators. Adders and subtractors-Cascading full adders, Look ahead carry adders, Binary comparators.	10 hrs
Unit – 2	
Chapter No. 4. Introduction to Sequential Circuits Basic Bistable Element, Latches, A SR Latch, Application of SR Latch, A Switch De-bouncer, The SR Latch, The gated SR Latch, The gated D Latch, The Master-Slave FlipFlops (Pulse-Triggered Flip-Flops): The Master-Slave SR Flip-Flops, The Master-Slave JK Flip-Flop, Edge Triggered Flip-Flop: The Positive Edge-Triggered D Flip-Flop, Negative-Edge Triggered D Flip-Flop; Characteristic Equations	10 hrs
Chapter No. 5. Analysis of Sequential Circuits Registers and Counters, Binary Ripple Counters, Synchronous Binary counters, Ring and Johnson Counters, Design of a Synchronous counters, Design of a Synchronous Mod-n Counter using clocked JK Flip-Flops Design of a Synchronous Mod-n Counter using clocked D, T or SR Flip-Flops.	10 hrs
Unit – 3	
Chapter No. 6. Sequential Circuit Design Introduction to Sequential Circuit Design, Mealy and Moore Models, State Machine notations, Synchronous Sequential Circuit Analysis, Construction of state Diagrams and counter design.	5 hrs

 KLE Technological University Creating Value Leveraging Knowledge	FORM ISO 9001: 2008	Document #: FMCD2005	Rev: 1.0
Department of Electrical & Electronics Engineering			
Syllabus			

Chapter No. 7. Introduction to memories Introduction and role of memory in a computer system, memory types and terminology, Read Only memory, MROM, PROM, EPROM, EEPROM, Random access memory, SRAM, DRAM, NVRAM.	5 hrs
---	-------

Text Books (List of books as mentioned in the approved syllabus)

1. Donald D Givone, Digital Principles and Design, Tata McGraw Hill, 2002
2. John M Yarbrough, Digital Logic Applications and Design, Thomson Learning, 2001
3. A Anand Kumar, Fundamentals of Digital Circuits, PHI, 2003

References

1. Charles H Roth, Fundamentals pf Logic Design, Thomson Learning, 2004
2. R.D.Sudhaker Samuel, Logic Design, Sanguine Technical Publishers, 2005
3. R P Jain, Modern Digital Electronics, Tata McGraw, 2000

 KLE Technological University Creating Value Leveraging Knowledge	FORM ISO 9001: 2008	Document #: FMCD2005	Rev: 1.0			
				Department of Electrical & Electronics Engineering		
				Syllabus		

Course Code: 19EEEC202

Course Title: Electrical Power Generation, Transmission & Distribution

L-T-P-Self Study: 3-0-0-0

Credits: 3

Contact Hrs: 40

ISA Marks: 50

ESA Marks: 50

Total Marks: 100

Teaching Hrs: 40

Exam Duration: 3 hrs

Content	Hrs
Unit - 1	
Chapter No. 1. Generating Stations. selection of Site, Classification, General arrangement and operation of Hydroelectric plant with components, General arrangement and operation of Thermal power plant with components, General arrangement and operation of Nuclear power plant with components, Safety of Nuclear power reactor, storing and processing of spent fuel.	5 hrs
Chapter No. 2. Substations and Economic operations Sub stations : Types, Bus-bar arrangement Schemes, location and substation equipment's Economics :Important terms and curves commonly used in system operation, effect of Voltage and frequency on loads , Scheduling of generators, Choice of size and number of generator units, Interconnection of power stations	5 hrs
Chapter No. 3. Typical Transmission & distribution systems Introduction, electric supply system, comparison of AC and DC systems, Standard Voltages of Transmission & Distribution. . Advantages of High Voltage Power Transmission. (effect of increase in voltage on weight of conductor, Line Efficiency & Line Voltage Drop) Feeders, Distributors & Service Mains. Conductor types.	2 hrs
Chapter No. 4. Overhead Transmission Line (Mechanical Design) Overhead transmission lines: introduction, components of a typical OH system. Line supports & placing of the conductors, single phase and three phase systems. Single circuit and double circuit.. Spacing of conductors, Length of span & Sag in OH lines. Sag calculation in conductors. (a) Suspended on level supports. (b) Supports at different levels. Effect of wind and ice. Tension and sag at erection. Corona Phenomena & Factors affecting corona in OH lines Expressions for Critical disruptive & visual critical voltage. and corona power loss	3 hrs
Unit - 2	
Chapter No. 5. Line parameters (Electrical Design) Introduction to transmission line constants i.e. Resistance, Inductance and capacitance . Distributed resistance of the transmission line, skin effect and proximity effect. Inductance of the single phase & three phase lines. Inductance calculation with equilateral and unsymmetrical spacing of the lines. Transposition of line conductors. Capacitance for single phase & three phase lines. Effect of earth on capacitance of the line. Numerical solutions on resistance calculations. Inductance & Capacitance calculations.	7 hrs
Chapter No. 6. Characteristics & Performance of Power transmission lines:	8 hrs

 KLE Technological University Creating Value Leveraging Knowledge	FORM ISO 9001: 2008	Document #: FMCD2005	Rev: 1.0			
				Department of Electrical & Electronics Engineering		
				Syllabus		

Introduction to Short transmission lines, calculations for short lines. Medium transmission lines. Nominal-T and π representation for transmission lines Long transmission lines. Long line solutions by Rigorous method, equivalent models, ABCD constants. .	
Unit - 3	
Chapter No. 7. Insulators Materials of insulators. Different types of insulators. Potential distribution over a string of suspension insulators. String efficiency and methods of increasing string efficiency. Testing of insulators.	5 hrs
Chapter No. 8. Underground Cables Underground Cables: Types of cables & material used for Insulation. Resistance, thermal rating of cables & charging current, Grading of cables Capacitance grading and inter sheath grading, testing of cables.	5 hrs

Text Books

1. Skrotzki and Wavopat, Power station Engineering and economics ., McGraw Hill, 1995

References

1. Soni, Gupta and Bhatnagar, A Course in Electrical Power, Dhanpatrai, 2014
 2. S M Singh, Electric Power generation , transmission and Distribution., Prentice Hall of India., 2012
 3. J B Gupta., Transmission and Distribution of Electrical power., Kataria, 2012
- V K Metha and Rohit Metha., Principles of Power System., S Chand & Company Ltd.,

 KLE Technological University Creating Value Leveraging Knowledge	FORM ISO 9001: 2008	Document #: FMCD2005	Rev: 1.0
	Department of Electrical & Electronics Engineering		
	Syllabus		

Course Title: Microcontroller Architecture & Programming

Course Code:

L-T-P: 0-1-1

Credits: 2

15EEEP201

Contact Hours:

CIE Marks: 80

SEE Marks:20

4Hrs/week

Total Marks: 100

Teaching + Lab. Hours: 48Hrs

Examination Duration:3 Hrs

1.	Overview of Architecture of 8051: <ul style="list-style-type: none"> • Processor Core and Functional Block Diagram • Description of memory organization • Overview of ALL SFR's and their basic functionality 	02+02 Hrs
2.	Low Level programming Concepts: <ul style="list-style-type: none"> • Addressing Modes • Instruction Set and Assembly Language programming(ALP) • Developing, Building, and Debugging ALP's 	02+02 Hrs
3.	Middle Level Programming Concepts: <ul style="list-style-type: none"> • Cross Compiler • Embedded C language implementation, programming, & debugging • Differences from ANSI-C • Memory Models • Library reference • Use of directives • Functions, Parameter passing and return types 	04+04Hrs
4.	On-Chip Peripherals Study,Programming, and Application: <ul style="list-style-type: none"> • Ports: Input/Output • Timers & Counters • UART • Interrupts 	04+04Hrs
5.	External Interfaces Study,Programming and Applications : <ul style="list-style-type: none"> • LEDES • Switches(Momentary type, Toggle type) • Seven Segment Display: (Normal mode, BCD mode,Internal Multiplexing & External Multiplexing) • LCD (8bit, 4bit, Busy flag, custom character generation) • Keypad Matrix 	04+04Hrs
6.	Selective Discussion during Project Development <ul style="list-style-type: none"> • A/D & D/A Converter • Stepper Motor, DC Motor • ZIGBEE • GSM/GPS • USB • MMC & SD • Ethernet MAC 	08+08Hrs

 KLE Technological University Creating Value Leveraging Knowledge	FORM ISO 9001: 2008	Document #: FMCD2005	Rev: 1.0
Department of Electrical & Electronics Engineering			
Syllabus			

Text Book*Text Books:*

1. Kenneth J. Ayala ; “The 8051 Microcontroller Architecture, Programming & Applications” 2e, Penram International, 1996 / Thomson Learning 2005
2. Muhammad Ali Mazidi and Janice Gillespie Mazidi and Rollin D. McKinlay; “The 8051 Microcontroller and Embedded Systems – using assembly and C ”- PHI, 2006 / Pearson, 2006

References *Books:*

1. Predko ; “Programming and Customizing the 8051 Microcontroller” –, TMH
2. Raj Kamal, “Microcontrollers: Architecture, Programming, Interfacing and System Design”, Pearson Education, 2005
3. Ajay V.Deshmukh; “Microcontrollers- Theory and Applications”,TMH,2005
4. Dr.RamaniKalpathi and Ganesh Raja; “Microcontroller and its applications”, Sanguine Technical publishers,Bangalore-2005

 KLE Technological University Creating Value Leveraging Knowledge	FORM ISO 9001: 2008	Document #: FMCD2005	Rev: 1.0
	Department of Electrical & Electronics Engineering		
	Syllabus		

Course Title: Digital Electronics Laboratory

Course Code: 15EEEP203

L-T-P: 0-0-1

Credits: 1

Contact Hours: 2Hrs/week

CIE Marks: 80

SEE Marks: 20

Total Marks: 100

Laboratory Hours: 28Hrs

Examination Duration: 3Hrs

List of Experiments:

1. Characterization of TTL & CMOS Gates– Propagation delay, Fan-in, Fan-out and Noise Margin.
2. Design and implement binary to gray, gray to binary, BCD to Ex-3 and Ex-3 to BCD code converters.
3. Design and implement BCD adder and Subtractor using 4 bit parallel adder.
4. Design and implement given functionality using decoders and multiplexers.
5. Design and implement n bit magnitude comparator using 4- bit comparators.
6. Design and implement Ring and Johnson counter using shift register.
7. Design and implement mod-6 synchronous and asynchronous counters using flip flops.
8. Design and implement a digital system to display a 3 bit counter on a 7 segment display. Demonstrate the results on a general purpose PCB.
9. Design and implement 1-bit serial adder. Demonstrate the results on a general purpose PCB.

Reference Books

1. Books/References: 1. K.A.Krishnamurthy “Digital lab primer”, Pearson Education Asia Publications, 2003.
2. “Electronic Principles” by A.P. Malvino, TaTa MGH,5th ED

	KLE Technological University Creating Value Leveraging Knowledge	FORM ISO 9001: 2008	Document #: FMCD2005	Rev: 1.0
Department of Electrical & Electronics Engineering				
Syllabus				

Course Title: Analog Electronics Laboratory

Course Code: 15EEEP202

L-T-P: 0-0-1

Credits: 1

Contact Hours: 2Hrs/week

CIE Marks: 80

SEE Marks: 20

Total Marks: 100

Laboratory Hours: 28Hrs

Examination Duration: 3Hrs

List of Experiments:

1. Design & Testing of Diode Clipping (single/double ended) circuits
2. Design & Testing of Clamping circuits for Positive and Negative Clamping.
3. Design of RC Coupled single stage FET/BJT amplifier & determination of the gain – frequency response, I/P & O/P impedance.
4. MOSFET characteristics
5. Design of single stage CS (MOSFET) amplifier & determination of the gain – frequency response.
6. Design of source follower using MOSFET.
7. Design and testing Current mirror circuit MOSFET
8. Design of two stage voltage series feed-back amplifier & determination of the gain, frequency response, i/p & o/p impedance with & without feedback
9. Design and testing of Transformer-less push-pull class B power amplifier
10. Design of Darlington Emitter follower with and without Bootstrapping and determines the gain, i/p and o/p impedance.

Reference Books

1. “Electronic Devices & circuit Theory “ by Nashelsky & Boylstead, PHI, 9th Ed
2. “Integrated Electronics“ By ‘Jacob Millman and Christos Halkias’, McGraw Hill,
3. “Electronic Principles” by A.P. Malvino, TaTa MGH, 5th Ed

 KLE Technological University Creating Value Leveraging Knowledge	FORM ISO 9001: 2008	Document #: FMCD2005	Rev: 1.0			
				Department of Electrical & Electronics Engineering		
				Syllabus		

Course Code: 19EEEC204
L-T-P : 4-0-0
ISA Marks: 50
Teaching Hrs: 50

Course Title: Electrical Machines
Credits: 3
ESA Marks: 50
Contact Hrs: 50
Total Marks: 100
Exam Duration: 3Hrs

Content	Hrs
Unit – 1	
Chapter 1: Transformers: Single phase transformer- Principle of operation and construction, Ideal transformer, Real transformer, Phasor diagrams, Equivalent circuit, Open-circuit test, Short-circuit test, Voltage regulation, Efficiency, Three phase transformers.	09 hours
Chapter 2: Three Phase Induction Machines: Principle of energy conversion in machines, Construction, Fundamental relationships- Slip, Rotor speed, Input power, Electromagnetic power, Electromagnetic (developed) torque, Mechanical power, Efficiency, Shaft torque. , Equivalent circuit, Analogies between induction machine and transformer, No-load and locked-rotor tests, Torque-speed characteristics, Starting, Speed control. Inverter fed induction motor.	11 hours
Unit – 2	
Chapter 3: DC Machines: Principle of operation, Construction of DC machine, Fundamental equations, Armature reaction, Classification of DC machines, DC generators, DC motors, Starting, Speed control of DC motors ,Braking, Switched Reluctance Machines- Construction, principle of operation , Aligned and unaligned positions, Electromagnetic torque, Advantages, disadvantages and Applications of SRMs, Steady state analysis of SRM. BLDC motor Construction and operation.	12 hours
Chapter 4: Synchronous Machines: Construction, Classification of synchronous machines, Electromotive force induced in armature winding, Generator and motor operation, Phasor diagrams of synchronous machine with Non-salient pole rotor and salient pole rotor, Voltage regulation calculation by EMF and MMF method, Synchronous motor, Synchronous motor as a synchronous condenser, Study of V and inverted V curves.	08 hours
Unit – 3	
Chapter 5: Synchronous Machines: Permanent magnet synchronous motors, Air gap magnetic flux density, Equivalent circuit of PM synchronous machine, Phasor diagram, Performance Characteristics of PM synchronous machine, Starting.	05 hours
Chapter 6: Single phase induction motors: Double revolving field theory, Equivalent circuit, Split-phase induction motor, Capacitor-start induction motor, Permanent split capacitor induction motor, Capacitor start capacitor-run induction motor, and Shaded pole induction motor.	05 hours

Text Book

1. Jacek F. Gieras, “Electrical Machines: Fundamentals of Electromechanical Energy Conversion”, CRC Press, Taylor & Francis Group, 2017.

References

1. P. C. Sen, “Principles of Electric Machines and Power Electronics”, John Wiley & Sons Publications, Canada, 2nd Edition, 2001.

 KLE Technological University Creating Value Leveraging Knowledge	FORM ISO 9001: 2008	Document #: FMCD2005	Rev: 1.0
Department of Electrical & Electronics Engineering			
Syllabus			

2. Bhimbra, “Principles of Electrical machinery”, Khanna Publishers.2006.
3. Mehrdad Ehsani...[et al.],“Modern electric, Hybrid electric, and Fuel Cell Vehicles: fundamentals, theory, and design.”, CRC Press, 2005.
4. T. J. E.Miller, “Brushless Permanent-Magnet and Reluctance Motor Drives”, Oxford Science Publications, 1989.

 KLE Technological University Creating Value Leveraging Knowledge	FORM ISO 9001: 2008	Document #: FMCD2005	Rev: 1.0			
				Department of Electrical & Electronics Engineering		
				Syllabus		

Course Code: 17EEEC204

Course Title: Linear Control Systems

L-T-P: 3-0-0

Credits: 3

Contact Hrs: 40

ISA Marks: 50

ESA Marks: 50

Total Marks: 100

Teaching Hrs: 50

Exam Duration: 3 hrs

Chapter No.	Unit-I	
1	Introduction to control systems: Open loop and closed loop control systems-definitions, salient features and simple examples	2 Hrs
2	Transfer function Models and block diagram representation: Definition of transfer function, assumptions and properties, Block diagram and signal flow graph representation, symbols used. Block-diagram of negative and positive feedback systems. Electrical systems: Derivation of transfer functions for electrical circuits, Models of dc servomotors-armature and field control, block-diagram representation. Block diagram reduction rules, Examples.	6 Hrs
3	Time Response Analysis Poles and Zeros, Type and order, Standard test signals. First order system: unit step response, importance of time constant, Second order system: Standard T.F of second order system. Unit step response of 2 nd order system Time response specifications-definition. Expressions for rise time, peak time, peak overshoot and settling time, Static error constants and steady-state errors.	7 Hrs
	Unit-II	
4	Stability Analysis of control systems: Explanation of Routh-Hurwitz criterion-necessary and sufficient condition for stability, special cases, Absolute and Relative stability, relative stability analysis.	5 Hrs
5	Controller design approaches: Basic modes of controls and their features: On-Off, proportional, integral, PI, PD and PID, Controller design approaches- Zeigler Nichol's tuning method and Pole placement design method, design examples	5 Hrs
6	Frequency response analysis: Sinusoidal response: system response for sinusoidal inputs, sinusoidal transfer functions. Frequency response of a second order system, definitions and expressions of Frequency response specifications. Polar plot: method to draw approximate polar plot, definition of phase and gain margin.	5 Hrs
	Unit-III	
7	Bode plot analysis of control systems: Bode plots: asymptotic plots for basic factors, method to draw Bode asymptotic plot and phase plot, determination of gain and phase margins from Bode plot.	5 Hrs
8	Root locus diagrams: Basic principle – magnitude and angle criterion, Rules to construct root locus diagram (proof not required), method to construct root locus diagram.	5 Hrs

Text Books

- 1 Nagarath and Gopal, *Control system Engineering*, Wiley Eastern Ltd., 1995, 2nd edition.
- 2 Katsuhiko Ogata, *Modern Control Engineering*, PHI, 2002, 4th edition

Reference Books:

- 1 M.Gopal, *Control Systems-Principles and Design*, 2, TMH, 2002.



Department of Electrical & Electronics Engineering

Syllabus

Course Code: **15EEEC207**
L-T-P-SS: **4-0-0-0**
CIE Marks: **50**
Teaching Hours:**50Hrs**

Course Title: **ARM Processor & Applications**
Credits: **4** Contact Hours:**4 Hrs/week**
SEE Marks:**50** Total Marks: **100**
Examination Duration:**3Hrs**

Content	Hrs
Unit - 1	
Chapter No.1 Interrupt programming 8051-Interrupts and programming (both assembly and ‘C’): Interrupts for timer and serial communication.	5 hrs
Chapter No.2 ARM Architecture The Acorn RISC machine, Architectural inheritance, Architecture of ARM7TDMI, ARM programmers model, ARM development tools, 3 stage pipeline ARM organization, ARM instruction execution.	5 hrs
Chapter No.3 Introduction to ARM instruction set Data processing instruction, Branch instruction, Load store instruction, Software interrupt instruction, Program status register instruction, Conditional execution, Example programs.	5 hrs
Unit - 2	
Chapter No.4 Introduction to THUMB instruction set The Thumb programmer model, ARM-Thumb interworking, other branch instructions, Data processing instructions, Single/Multiple register load store instruction, Stack operation, Software interrupt instructions, example programs.	2 hrs
Chapter No.5 Assembler rules and Directives Introduction, structure of assembly language modules, Predefined register names, frequently used directives, Macros, Miscellaneous assembler features. Example programs.	4 hrs
Chapter No.6 Exception handling Introduction, Interrupts, error conditions, processor exception sequence, the vector table, Exception handlers, Exception priorities, Procedures for handling exceptions.	4 hrs
Chapter No.7 Architectural support for high level languages Abstraction in software design, data types, floating point data types, The ARM floating point architecture, use of memory, run time environment.	5 hrs
Unit - 3	
Chapter No.8 LPC2148 Architecture and applications On-chip memory, GPIOs, Timers, UART, ADC, I2C, SPI , RTC, ARM interfacing techniques and programming: LED, LCD, Stepper Motor, Buzzer, Keypad, ADC and I2C	10 hrs

	KLE Technological University <small>Creating Value Leveraging Knowledge</small>	FORM ISO 9001: 2008	Document #: FMCD2005	Rev: 1.0
Department of Electrical & Electronics Engineering				
Syllabus				

.	
---	--

Text Books (List of books as mentioned in the approved syllabus)

1.	Steve Furber, ARM System- on-Chip Architecture, 2nd, LPE, 2002
2.	William Hohl, ARM Assembly Language fundamentals and Techniques, 1st, CRC press, 2009

References

- “ARM system Developer’s Guide”- Hardbound, Publication date: 2004 Imprint: MORGAN KAUFFMAN
- User manual on LPC21XX.

 KLE Technological University Creating Value Leveraging Knowledge	FORM ISO 9001: 2008	Document #: FMCD2005	Rev: 1.0			
				Department of Electrical & Electronics Engineering		
				Syllabus		

Course Title: ARM Microcontroller Lab

Course Code: 15EEEP205

L-T-P: 0-0-1

Credits: 1

Contact Hours: 2Hrs/week

CIE Marks: 80

SEE Marks: 20

Total Marks: 100

Teaching Hours: 25Hrs

Examination Duration: 2 Hrs

Chapter No.	List of Experiments
1	Write an ALP to achieve the following arithmetic operations: i. 32 bit addition ii. 64 bit addition iii. Subtraction iv. Multiplication v. 32 bit binary divide
2	Write an ALP for the following using loops: i. Find the sum of 'N' 16 bit numbers ii. Find the maximum/minimum of N numbers iii. Find the factorial of a given number with and without look up table.
3	Write an ALP to i. Find the length of the carriage return terminated string. ii. Compare two strings for equality. ii.
4	Write an ALP to pass parameters to a subroutine to find the factorial of a number or prime number generation.
5	Write a 'C' program to test working of LED's using LPC2148.
6	Write a 'C' program & demonstrate an interfacing of Alphanumeric LCD 2X16 panel to LPC2148 Microcontroller.
7	Write an ALP to generate the following waveforms of different frequencies i. Square wave ii. Triangular iii. Sine wave II. Write a 'C' program & demonstrate interfacing of buzzer to LPC2148(using external interrupt)
8	Write a program to set up communication between 2 microcontrollers using I2C.
9	Write a 'C' program & demonstrate an interfacing of ADC.
Structured Enquiry	
1	Write a program that displays a value of 'Y' at port 0 and 'N' at port 2 and also generates a square wave of 10KHz with Timer 0 in mode 2 at port pin p1.2 XTAL =22MHz
2	Write a C program that continuously gets a single bit of data from P1.7 and sends it to P1.0 in main, while simultaneously i. creating a square wave of 200us period on pin P2.5. ii. Sending letter 'A' to serial port. Use Timer 0 to create square wave.
Open Ended	
1	Develop an ARM based application using i. sensors ii. Actuators iii. displays

 KLE Technological University Creating Value Leveraging Knowledge	FORM ISO 9001: 2008	Document #: FMCD2005	Rev: 1.0
	Department of Electrical & Electronics Engineering		
	Syllabus		

Course Title: Digital System Design using Verilog

Course Code: 18EEEP203

L-T-P: 0-0-2

Credits: 2

Contact Hours: 4Hrs/week

ISA Marks: 80

SEA Marks:20

Total Marks: 100

Teaching + Lab.

Examination Duration: 2 Hrs

Hours: 48 Hrs

1.	Chapter No. 1. Architecture of FPGA Architecture of FPGS: Spartan 3, What Is HDL, Verilog HDL Data Types and Operators.	4hrs
2.	Chapter No. 2. Data Flow Descriptions Highlights of Data-Flow Descriptions, Structure of Data-Flow Description, Data Type – Vectors, Testbench.	6 hrs
3.	Chapter No. 3. Behavioral Descriptions Behavioral Description highlights, structure of HDL behavioral Description, The VHDL variable –Assignment Statement, sequential statements, Tasks and Functions	10 hrs
4.	Chapter No. 4. Structural Descriptions Highlights of structural Description, Organization of the structural Descriptions, Binding, state Machines, Generate, Generic, and Parameter statements	10 hrs
5.	Chapter No. 5:Finite State Machine: Moore Machines, Mealy Machines	4hrs
6.	Chapter No. 6:Timing Issues in Digital Circuits: Setup Time Constraints, Hold Time Constraints, Static Time analysis, Critical Path, Clock Skew.	6hrs
7.	Chapter No. 7. Advanced HDL Descriptions File operations in Verilog, Memories: RAM, ROM, Block Memories(Xilinx IP)	8hrs

 KLE Technological University Creating Value Leveraging Knowledge	FORM ISO 9001: 2008	Document #: FMCD2005	Rev: 1.0			
				Department of Electrical & Electronics Engineering		
				Syllabus		

Course code: 17EEEC302

Course title: Power System Analysis & Stability

CIE Marks: 50

Teaching hours: 40

SEE Marks: 50

Course Content	Hrs
Unit - 1	
Chapter No. 1: Power system representation Standard symbols of power system components, one-line diagram, impedance and reactance diagrams, per-unit quantity-definition, per-unit impedance of 3-phase component, change of base, equivalent load impedance, p.u impedance of two-winding transformer referred to primary and secondary, method to draw p.u impedance diagram, advantages of p.u system calculations, examples on obtaining per-unit reactance diagram and per-unit calculations	6 hrs
Chapter No. 2: Symmetrical fault analysis 3-Phase short circuit at the terminals of unloaded generator, definitions of sub-transient, transient and steady-state reactance, internal emf's of loaded machines, examples on short circuit calculations, selection of circuit breaker ratings-momentary current and interrupting capacity, examples on symmetrical fault calculations.	5 hrs
Chapter No. 3: Introduction to Symmetrical components and sequence networks Definition of sequence components as applied to 3-phase unbalanced systems, expressions for sequence components, examples on computations of sequence components.	4 hrs
Unit - 2	
Chapter No. 4 Sequence Networks Sequence impedance and sequence network, sequence networks of 3-phase generator, zero-sequence networks of 3-phase loads and transformers, Sequence network of power systems	4 hrs
Chapter No. 5: Unsymmetrical Fault Analysis Single line to ground, line to line and double line to ground fault with fault impedance at the terminals of unloaded generator- derivation of connection of sequence networks, Unsymmetrical faults on unloaded power systems, examples on unsymmetrical fault calculation for unloaded power systems.	7 hrs
Chapter No. 6: Introduction to power system Stability Power angle equation of SMIB system, steady-state analysis, M&H constants-definitions and relation, swing equation, equal area criterion (EAC),	4 hrs
Unit - 3	
Chapter No. 7: Stability analysis by EAC: EAC applications to to-sudden change in mechanical power input, 3-phase fault on transmission line, expression for critical clearing angle, examples on EAC applications	5 hrs
Chapter No. 8: Numerical solution of swing equation for stability analysis Point by point method of solving swing equation, applications of Euler, modified Euler and R-K numerical techniques for stability analysis, methods to improve transient stability, examples on stability analysis	5 hrs

Text Books

1. W.D. Stevenson, Elements of Power System Analysis, 4th Edition, McGraw Hill, 1982
2. I.J. Nagarath and D.P. Kothari, Power System Engineering, 2nd Edition, Tata McGraw Hill, 2010

Reference Books

1. Hadi Sadat, Power System Analysis, First Edition, Tata McGraw Hill, 2002
2. Nagarath and Kothari, Modern Power System Analysis, 2nd Edition, Tata McGraw Hill, 1993
3. J.J. Grainger and W.D. Stevenson, Power System Analysis, McGraw Hill (New York), 1994

 KLE Technological University Creating Value Leveraging Knowledge	FORM ISO 9001: 2008	Document #: FMCD2005	Rev: 1.0			
				Department of Electrical & Electronics Engineering		
				Syllabus		

Course Code: 21EEEC301	Course Title: Electric Drives & Control	
L-T-P-Self Study: 3-0-0	Credits: 3	Contact Hrs: 40
ISA Marks: 50	ESA Marks: 50	Total Marks: 100
Teaching Hrs: 40		Exam Duration: 3 hrs
Content		Hrs
Unit - 1		
Chapter No.1 :An introduction to Electrical Drives & its Dynamics Electrical drives. Advantages of electrical drives. Parts of electrical drives, Choice of electrical drives, status of dc and ac drives, Dynamics of electrical drives, Fundamental torque equation, speed torque conventions and multi quadrant operation. Nature and classification of load torques, calculation of time and energy loss in transient operations.		5 hrs
Chapter No.2: D C Motor Drives Starting braking, single phase fully controlled rectifier, control of dc separately excited motor, Single-phase half controlled rectifier control of dc separately excited motor. Three phase fully controlled rectifier control of dc separately excited motor, three phase half controlled rectifier control of dc separately excited motor, multi-quadrant operation of dc separately excited motor fed from fully controlled rectifier. Rectifier control of dc series motor, chopper controlled dc drives, chopper control of separately excited dc motor. Chopper control of series motor.		10 hrs
Unit - 2		
Chapter No. 3: Induction Motor Drives Operation with unbalanced source voltage and single phasing, operation with unbalanced rotor impedances, analysis of induction motor fed from non-sinusoidal voltage supply, starting, braking, stator voltage control, variable voltage, variable frequency control from voltage sources, voltage source inverter control, current source inverter control, current regulated voltage source inverter control, rotor resistance control, slip power recovery.		10 hrs
Chapter No. 4: Synchronous Motor and Brushless DC Motor Drives Operation from fixed frequency supply, synchronous motor variable speed drives, variable frequency control of multiple synchronous motors, self-controlled synchronous motor drive, PMAC motor drives, brushless dc motor drives.		5 hrs
Unit - 3		
Chapter No. 5:Stepper Motor and Switched Reluctance Motor Drives Stepper Motor: variable reluctance, permanent magnet, torque versus stepping rate characteristics drive circuits for stepper motors Switched Reluctance Motor: Operation and control requirements, converter circuits, modes of operation		5 hrs
Chapter No. 6: Solar and Battery Powered Drives Solar panels, motors suitable for pump drives, battery powered vehicles, solar powered electrical vehicles		5 hrs

	KLE Technological University <small>Creating Value Leveraging Knowledge</small>	FORM ISO 9001: 2008	Document #: FMCD2005	Rev: 1.0
Department of Electrical & Electronics Engineering				
Syllabus				

Text Books (List of books as mentioned in the approved syllabus)

1. G. K Dubey, Fundamentals of Electrical Drives, 2, Narosa Publishing House, Chennai, 2002

References

1. N. K. De and P. K. Sen, Electrical Drives, PHI, 2007
2. S. K. Pillai, A First Course On Electric Drives, Wiley Eastern Ltd, 1990
3. V. R. Moorthi, Power Electronics, Devices, Circuits & Industrial Applications, Oxford University Press, 2005

 KLE Technological University Creating Value Leveraging Knowledge	FORM ISO 9001: 2008	Document #: FMCD2005	Rev: 1.0
Syllabus			

Course Code: 17EEEC303

L-T-P-SS: 3-0-0

CIE Marks: 40 SEE Marks: 50

Teaching Hrs: 40 hrs

Course Title: OS and Embedded Systems

Credits: 3

Contact Hrs: 3 hrs/week

Total Marks: 100

Exam Duration: 3 hrs

No	Content	Hrs
Unit I		
1	Introduction and System structures Operating system definition; Operating System operations; Different types of operating system – Mainframe systems, Multi programmed systems, Time sharing systems, Desktop systems, Parallel systems, Distributed systems, Real time systems.	03 Hrs
	Process Management Process concept; Process scheduling; Operations on processes; Inter-process communication. Multi-Threaded Programming: Overview; Multi threading models; Thread Libraries; Threading issues. Process Scheduling: Basic concepts; Scheduling criteria; Scheduling algorithms; Multiple-Processor scheduling; Thread scheduling.	06 Hrs
	Memory Management Memory Management Strategies: Background; Swapping; Contiguous memory allocation; Paging; Structure of page table; Segmentation. Virtual Memory Management: Background; Demand paging; Page replacement; Allocation of frames; Thrashing. (Textbook: Galvin)	06 Hrs
Unit II		
4	Introduction To Real-Time Operating Systems Introduction To Real-Time Operating Systems: Introduction to OS, Introduction to real time embedded system- real time systems, characteristics of real time systems , the future of embedded systems. Introduction to RTOS, key characteristics of RTOS, its kernel, components in RTOS kernel, objects, scheduler, services, context switch, Scheduling types: Preemptive priority-based scheduling, Round-robin and preemptive scheduling.	08 Hrs
	Tasks, Semaphores and Message Queues: Tasks, Semaphores and Message Queues: A task, its structure, A typical finite state machine, Steps showing the how FSM works. A semaphore, its structure, binary semaphore, mutual exclusion (mutex) semaphore, Synchronization between two tasks and multiple tasks, Single shared-resource-access synchronization, Recursive shared-resource-access synchronization. A message queue, its structure, Message copying and memory use for sending and receiving messages, Sending messages in FIFO or LIFO order, broadcasting messages. (Textbook: Qing Li with Caroline Yao, Real-Time Concepts for Embedded Systems, 1E, Published, 2011)	07 Hrs
3	Unit III Typical Embedded System: Classification and purposes of embedded system, Characters and Quality attributes of embedded system, Core and Supporting components of embedded system, Embedded firmware (Text book: Shibu KV)	05 Hrs
	Wired and Wireless Protocols: Bus communication protocol (USB,I²C,SPI), Wireless and mobile system protocol (Bluetooth, 802.11 and its variants, ZigBee), Embedded design cycle-case study-ACVM (Text book: Rajkamal)	05 Hrs

 KLE Technological University Creating Value Leveraging Knowledge	FORM ISO 9001: 2008	Document #: FMCD2005	Rev: 1.0			
				Department of Electrical & Electronics Engineering		
				Syllabus		

Course Code: 18EEEC301

Course Title: Linear Integrated Circuits

L-T-P: 3-0-0

Credits: 3

Contact Hrs: 40

CIE Marks: 50

SEE Marks: 50

Total Marks: 100

Teaching Hrs: 40

Exam Duration: 3 hrs

Chapter No.	Unit-I	
1	Current Mirrors Current Mirror circuits and Modeling, Figures of merit (output impedance, voltage swing), Widlar, Cascode and Wilson current Mirrors, Current source and current sink.	05 Hrs
2	Basic OPAMP architecture Basic differential amplifier, Common mode and difference mode gain, CMRR, 5-pack differential amplifier, 7-pack operational amplifier, Slew rate limitation, Instability and Compensation, Bandwidth and frequency response curve	06 Hrs
3	OPAMP characteristics Ideal and non-ideal OPAMP terminal characteristics, Input and output impedance, output Offset voltage, Small signal and Large signal bandwidth.	04 Hrs
Unit-II		
4	OPAMP with Feedback OPAMP under Positive and Negative feedback, Impact Negative feedback on linearity, Offset voltage, Bandwidth, Input and Output impedances, Follower property, Inversion property	05Hrs
5	Linear applications of OPAMP DC and AC Amplifiers, Voltage Follower, Summing, Scaling and Averaging amplifiers (Inverting, Non-inverting and Differential configuration), Integrator, Differentiator, Current amplifiers, Instrumentation amplifier, Phase shifters, Voltage to current converter, Phase shift oscillator, Weinbridge oscillator, Active Filters –First and second order Low pass & High pass filters.	10 Hrs
Unit-III		
6	Nonlinear applications of OPAMP Crossing detectors (ZCD. Comparator), Schmitt trigger circuits, Monostable & Astable multivibrator, Triangular/rectangular wave generators, Waveform generator, Voltage controlled Oscillator, Precision rectifiers, Limiting circuits. Clamping circuits, Peak detectors, sample and hold circuits, Log and antilog amplifiers, Multiplier and divider Amplifiers, Voltage Regulators.	10 Hrs

Text Books

- 1 Sedra and Smith, “Microelectronics”, 5th edition, Oxford University Press.
- 2 Ramakant A. Gayakwad, “Op - Amps and Linear Integrated Circuits”, 4th edition, PHI.

Reference Books:

- 1 Robert. F. Coughlin & Fredrick F. Driscoll, “Operational Amplifiers and Linear Integrated Circuits”, PHI/Pearson, 2006.
- 2 James M. Fiore, “Op - Amps and Linear Integrated Circuits”, Thomson Learning, 2001
- 3 Sergio Franco, “Design with Operational Amplifiers and Analog Integrated Circuits”, TMH, 3e, 2005
- 4 David A. Bell, “Operational Amplifiers and Linear IC’s”, 2nd edition, PHI/Pearson, 2004

 KLE Technological University Creating Value Leveraging Knowledge	FORM ISO 9001: 2008	Document #: FMCD2005	Rev: 1.0
	Department of Electrical & Electronics Engineering		
	Syllabus		

Course code: 19EEEC301

L-T-P: 2-0-1

Course title: Machine Learning

CIE Marks: 50

Teaching hours: 40

ESA Marks: 50

Chapter No.	Unit-I	
1	Introduction Introduction to Machine Learning, Applications of Machine Learning, Types of Machine Learning: Supervised, Unsupervised and Reinforcement learning, Dataset formats, Basic terminologies.	5 hrs
2	Supervised Learning Linear Regression, Logistic Regression Linear Regression: Single and Multiple variables, Sum of squares error function, The Gradient descent algorithm, Application, Logistic Regression, The cost function, Classification using logistic regression, one-vs-all classification using logistic regression, Regularization.	10 hrs
Unit-II		
3	Supervised Learning: Neural Network Introduction to perception learning, Implementing simple gates XOR, AND, OR using neural network. Model representation, Gradient checking, Back propagation algorithm, Multi-class classification, Application- classifying digits, SVM.	10 hrs
4	Unsupervised Learning: Clustering Introduction, K means Clustering, Algorithm, Cost function, Application.	5 hrs
Unit-III		
5	Unsupervised Learning: Dimensionality Reduction Dimensionality reduction, PCA- Principal Component Analysis. Applications, Clustering data and PCA.	4 hrs
6	Introduction to Deep Learning What is deep learning?, Difference between machine learning and deep learning, Convolution Neural Networks (CNN), Recurrent Neural Networks(RNN), When to use deep learning?	8 hrs

Text Books

- 1 Tom Mitchell, Machine Learning, 1, McGraw-Hill. , 1997
- 2 Christopher Bishop, Pattern Recognition and Machine Learning, 1, Springer, 2007

Reference Books:

- 1 Trevor Hastie, Robert Tibshirani, Jerome Friedman, The Elements of Statistical Learning : Data Mining, Inference and Prediction, 2, Springer, 2009

	KLE Technological University Creating Value Leveraging Knowledge	FORM ISO 9001: 2008	Document #: FMCD2005	Rev: 1.0
Department of Electrical & Electronics Engineering				
Syllabus				

Course Code: 17EEEP306

Course Title: RTOS Lab

L-T-P: 0-0-1

Credits: 1

Contact Hrs: 32

CIE Marks: 20

SEE Marks: 80

Total Marks: 100

Teaching Hrs: 32

Exam Duration: 2 hrs

Expt No.	List of Experiments
1	Write a C program to use on chip Timers in LPC2148 and generate required delay
2	Write a C program to demonstrate the concept of basic RTOS programming by using RTX RTOS
3	Write a 'C' program & demonstrate concept of Round Robin Task Scheduling.
	Write a C program to demonstrate the concept of basic preemptive scheduling algorithm by using RTX RTOS
4	Write a 'C' program & demonstrate concept of Events and Flags for inter task communication using RTX RTOS
5	Write a 'C' program & demonstrate concept of Mailbox.
6	Write a 'C' program & demonstrate concept of Semaphore.
7	Write a 'C' program & demonstrate concept of interrupts(hardware and software)
	Write a C program to interface I2C-RTC with LPC2148
8	Write a C program to interface SPI-EEPROM with LPC2148
	Structured Enquiry
9	Real-Time OS Application which successfully demonstrates the use of various RTOS concepts

 KLE Technological University Creating Value Leveraging Knowledge	FORM ISO 9001: 2008	Document #: FMCD2005	Rev: 1.0			
				Department of Electrical & Electronics Engineering		
				Syllabus		

Course Title: Machines lab

L-T-P: 0-0-1

CIE Marks: 80

Laboratory Hours: 28Hrs

Credits: 1

SEE Marks: 20

Examination Duration: 3Hrs

Course Code: 19EEEP301

Contact Hours: 2Hrs/week

Total Marks: 100

Category: Demonstration	
Expt./ Job No.	Experiment / Job Details
1	Star and Delta Connected Lighting Loads
2	Open circuit characteristics of DC machine
3	Speed control of separately excited DC motor by armature voltage control and flux control
4	Synchronization of Alternator with Bus bar/ Parallel operation of Alternator
Category: Exercise	
Expt./ Job No.	Experiment / Job Details
1	To Conduct NO – LOAD & BLOCKED ROTOR test on a given Induction motor to a) Find the performance parameters b) Represent the motor by its equivalent circuit model referred to Stator or Rotor.
2	To Conduct Open Circuit and Short Circuit test on given single phase transformer to a) Calculate efficiency and voltage regulation at different loads & power factors. b) Draw the transformer equivalent circuit model.
3	Load test on 3Ø Induction motor
4	Three phase Transformer bank using three single phase transformers with different configurations of primary and secondary windings.
5	Speed control of Induction motor by V/f method
6	Performance study of synchronous motor with change in its excitation (V and Inverted V curves)
7	Voltage regulation of an Alternator by EMF and MMF method
Category: Structured Enquiry	
Expt./ Job No.	Experiment / Job Details
1	To develop the second order response surface methodology (RSM) based speed prediction model of DC shunt motor by conducting experiments as per Design of Experiments.(DOE)

 KLE Technological University Creating Value Leveraging Knowledge	FORM ISO 9001: 2008	Document #: FMCD2005	Rev: 1.0			
				Department of Electrical & Electronics Engineering		
				Syllabus		

Course Title: Linear Integrated Circuits and Control System Lab		Course Code: 21EEEP301
L-T-P: 0-0-1	Credit:1	Contact Hours: 2hrs/week
CIE Marks:80	SEE Marks: 20	Total Marks:100
Laboratory Hours: 2hrs	Exam Duration:2 hrs	

Expt. No.	List of Experiments
Demonstration	
1.	Demonstration of Basic Op Amp Circuits
Exercises	
1.	Design and implementation of Rectifier Circuits
2.	Design and implementation of Wave shaping circuits (clippers and clampers)
3.	Design and implementation of Filter circuits (LPF and HPF)
4.	Design and implementation of waveform generating circuits (Schmitt trigger and Zero Crossing Detector)
5.	Design and simulation of Data converter circuits (R-2R D-A Converter)
6.	Design and analyze time response specifications of second order system
7.	Design and analyze frequency response specifications of second order system
8.	Design and analyze Lag and Lead Compensators
Structured Enquiry	
1.	Simulate and Investigate the effect of P, PI, PID controllers on the time response of a given second order series RLC system.

Books:

1. Op amps and Linear Integrated Circuits by Ramakant A. Gayakwad
2. Nagarath and Gopal, Control System Engineering, 2, Wiley-Eastern Limited, 1995.
3. K. Ogata, Modern Control Engineering, 4th Edition, PHI, 2002.

References:

1. Op-amps and Linear ICs by Prof. B.N. Yoganarasimhan
2. M. Gopal, Control Systems-Principles and Design, 2, TMH, 2002.

	KLE Technological University Creating Value Leveraging Knowledge	FORM ISO 9001: 2008	Document #: FMCD2005	Rev: 1.0
Department of Electrical & Electronics Engineering				
Syllabus				

Course Code: 17EEEW301
L-T-P: 0-0-3 Credits:3
CIE Marks: 50 SEE Marks: 50

Title: Mini Project
Contact Hrs: 3 hrs/week
Total Marks: 100

Students are supposed to carry out the mini project based on the theme and guidelines as given below.

(I) Theme: A Computer Aided Solution to Electrical Engineering Problems

1. The work must involve designing and developing a computer solution to an electrical engineering problem with the help of a computer program written in C/C++.
2. Computer program must make use of data structures /algorithms suitable to the problem being solved.
3. The solution must involve mathematical modeling, mathematical solution and numerical methods.
4. Computer program design must be well documented through flowcharts.
5. Computer program must have a user manual and source code documentation.
6. Computer program must generate a clear, concise report that is useful for other users.
7. The solution must be documented in a report consisting of problem definition, methodology, modeling, solution, results and discussion and conclusions.

(II) Project batches and Guide:

Each project batch consists of 3 or 4 students. Students are informed to form their own batch based on the kind of project work and their interest. Each batch is supposed to give four faculty names as guides in the order of their preference. Guides will be allocated based on the preference given by the batch. The primary role of the guide is to supervise the work, provide appropriate guidance in successfully carrying out the project work.

(III) Project implementation

The principle steps in carrying out the project work are summarized below:

Step-1: Literature survey:

A literature survey with regard to the given theme is to be carried out in order to understand the state of the current research. Further, a critical review of the collected literature will facilitate to summarize key observations. Key observations will lead to identifying a specific problem for the project work in terms of alternate/new solution techniques, possible improvements, new formulations or models, hardware implementations etc.

Step-2: Prepare a synopsis:

A synopsis highlights the definition of identified problem and its significance. The synopsis will also contain detailed literature review giving the state of the current research on the selected specialized area.

 KLE Technological University Creating Value Leveraging Knowledge	FORM ISO 9001: 2008	Document #: FMCD2005	Rev: 1.0
	Department of Electrical & Electronics Engineering		
	Syllabus		

It will also brief the problem formulation, solution methodology, tools employed and possible outcomes.

Step-3: Project implementation:

The work is to be carried out in phase wise manner, testing or analyzing the partial results obtained. Guide will periodically monitor the progress of the work done giving suitable suggestions as required.

(IV) Schedule:

Sl. No.	Activity	Week No.	Evaluation Objectives
1	Announcement for the formation of batches	At the end of the previous semester	NA
2	Allotment of guides	1 st - 2 nd	NA
3	Submission of Synopsis	3 rd - 5 th	Literature review, problem formulation, solution methodology, tools employed
4	Review-I	6 th - 8 th	Literature review, problem formulation, solution methodology, tools employed
5	Review-II	9 th - 10 th	Analysis and implementation (partial)
6	Review-III	12 th - 14 th	Analysis, complete implementation and results.

Evaluation:

Evaluation of the project work carried out by each batch will be reviewed periodically by a review committee. Review committee consists of guide and two other faculty members who are guiding other batches. Generally, two to three reviews will be held during a semester. However, each project batch will be supervised by the guide on a weekly basis. Review committee will evaluate for 40% and guide will evaluate for 60% of the total marks.

Continuous Internal Evaluation (50%)	Assessment	Weightage in Marks
	Evaluation by Project Guide	30
Project Review committee	20	
Semester End Examination (50%)	Using SEE Rubrics	50
	Total	100

Passing: 40% both in CIE and SEE



Department of Electrical & Electronics Engineering

Syllabus

Course Code: 17EEEC307

L-T-P-SS: 3-0-0 Credits:3

CIE Marks: 50 SEE Marks: 50

Teaching Hrs: 40hrs

Course Title: Automotive Electronics

Contact Hrs: 3 hrs/week

Total Marks: 100

Exam Duration: 3 hrs

Unit I		
No	Content	Hrs
1	Automotive Systems, Design cycle and Automotive industry overview Overview of Automotive industry, Vehicle functional domains and their requirements, automotive supply chain, global challenges. Role of technology in Automotive Electronics and interdisciplinary design. Introduction to modern automotive systems and need for electronics in automobiles and application areas of electronic systems in modern automobiles, Introduction to power train, Automotive transmissions system ,Vehicle braking fundamentals, Steering Control, Overview of Hybrid Vehicles ECU Design Cycle : Types of model development cycles(V and A) , Components of ECU, Examples of ECU on Chassis, Infotainment, Body Electronics and cluster	8
2	Automotive Sensors and Actuators: Sensor characteristics, Sensor response, Sensor error, Redundancy of sensors in ECUs, Avoiding redundancy, Smart Nodes , Examples of sensors : Accelerometer (knock sensors),wheel speed sensors, Engine speed sensor, Vehicle speed sensor, Throttle position sensor, Temperature sensor, Mass air flow (MAF) rate sensor, Exhaust gas oxygen concentration sensor, Throttle plate angular position sensor, Crankshaft angular position/RPM sensor, Manifold Absolute Pressure (MAP) sensor. Actuators: Engine Control Actuators, Solenoid actuator, Exhaust Gas Recirculation Actuator.	7
Unit II		
3	Embedded system in Automotive Applications & Automotive safety systems: Review of microprocessor, microcontroller and digital signal processor within the automotive context. Criteria to choose the right microcontroller/processor for various automotive applications, Architectural attributes relevant to automotive applications Automotive grade processors ex: Renesas, Quorivva, Infineon. EMS: Engine control functions, Fuel control, Electronic systems in Engines , Development of control algorithm for EMS, Look-up tables and maps, Need of maps, Procedure to generate maps, Fuel maps/tables, Ignition maps/tables, Engine calibration, Torque table, Dynamometer testing Safety Systems in Automobiles: Active and Passive safety systems: ABS, TCS, ESP, Brake assist, Airbag systems etc.	10
4	Automotive communication protocols : Overview of Automotive communication protocols : CAN, LIN , Flex Ray, MOST	5
Unit – III		
5	Advanced Driver Assistance Systems (ADAS) and Functional safety standards: Advanced Driver Assistance Systems (ADAS):Examples of assistance applications: Lane Departure Warning, Collision Warning, Automatic Cruise Control, Pedestrian Protection, Headlights Control, Connected Cars technology and trends towards Autonomous vehicles. Functional Safety: Need for safety standard-ISO 26262, safety concept, safety process for product life cycle, safety by design, validation	5

	KLE Technological University Creating Value Leveraging Knowledge	FORM ISO 9001: 2008	Document #: FMCD2005	Rev: 1.0
Department of Electrical & Electronics Engineering				
Syllabus				

6	Diagnostics: Fundamentals of Diagnostics: Basic wiring system and Multiplex wiring system, Preliminary checks and adjustments, Self-diagnostic system. Fault finding and corrective measures, Electronic transmission checks and Diagnosis, Diagnostic procedures and sequence, On board and off board diagnostics in Automobiles, OBDII, Concept of DTCs, DLC, MIL, Freeze Frames, History memory, Diagnostic tools, Diagnostic protocols : KWP2000 and UDS	5
----------	---	----------

Text Book:

1. Ribbens – Understanding of Automotive electronics
2. Denton.T – Automobile Electrical and Electronic Systems.
3. Denton.T – Advanced automotive fault diagnosis

References:

1. Ronald K Jurgen: "Automotive Electronics Handbook, 2nd Edition, McGraw-Hill, 1999
2. James D Halderman: -Automotive electricity and Electronics", PHI Publication
3. Terence Rybak. Mark Stefika: Automotive Electromagnetic Compatibility (EMC), Springer. 2004
4. Allan Bonnick.: “Automotive Computer Controlled Systems” Diagnostic Tools and Techniques". Elsevier Science, 2001
5. William T.M – Automotive Electronic Systems.
6. Nicholas Navet – Automotive Embedded System Handbook 2009.
7. BOSCH Automotive Handbook, 6th Edition.

 KLE Technological University Creating Value Leveraging Knowledge	FORM ISO 9001: 2008	Document #: FMCD2005	Rev: 1.0
Syllabus			

Course Code: 19EEEC303

L-T-P: 2-0-1

ISA Marks: 50

Teaching Hrs: 40

Course Title: Object Oriented Programming using C++

Credits: 3

ESA Marks: 50

Contact Hrs: 3

Total Marks: 100

Exam Duration: 03 hrs

Content	Hrs
Unit - 1	
Chapter 01: Introduction Principles of Object Oriented Programming, Procedure oriented and Object oriented Programming, Basic Concepts of OOP, Benefits and Applications of OOP, Beginning with C++, Simple C++ program, C++ with classes, Structure of C++ program, Creating, compiling and linking C++ programs.	4 hrs
Chapter 02: Classes and Objects Structures and Classes, Specifying a Class, Defining Member functions, C++ program with class, Access Specifiers, Scope Resolution Operators, Inline functions, Static Data Members, Static Member Functions, Friend Functions.	7 hrs
Chapter 03: Constructors and Destructors Introduction, Parameterized Constructors, Multiple Constructors, Copy Constructor, Dynamic Constructor, Destructors, Dynamic allocation of objects - new and delete operators.	4 hrs
Unit - 2	
Chapter 04: Inheritance Introduction, Defining Derived Classes, Types of Inheritance, Virtual Base Classes, Abstract Classes, Constructors in Derived Classes, Nesting of Classes.	6 hrs
Chapter 05: Virtual Functions and Polymorphism Pointers to objects, this pointer, Pointers to Derived classes, Virtual Functions. Pure Virtual Functions.	5 hrs
Chapter 06: Exception Handling Basics, Exception Handling Mechanism, Throwing, Catching and Rethrowing Exceptions.	4 hrs
Unit - 3	
Chapter 07: Function Overloading, Operator Overloading Function Overloading, Overloading Constructors, Defining operator Overloading, Unary and Binary operator overloading, Rules for overloading operators.	5 hrs
Chapter 08: Templates, STL Class Templates, Function Templates, Overloading of Template functions, Components of STL, Containers, Iterators, Application of Container Classes.	5 hrs

Text Books (List of books as mentioned in the approved syllabus)

1. E.Balagurusamy, Object Oriented Programming with C++, 4th edition, Tata McGrawHill, 2008
2. Herbert Schildt, C++ The Complete Reference, Fourth Edition, Tata McGrawHill, 2003

References

1. Yashavant P. Kanetkar, Let Us C++, 1st, BPB Publications,
2. Stanley B.Lippmann, Josee Lajore, Barbara E. Moo, C++ Primer, 4th Edition, Pearson Education, 2005

 KLE Technological University <small>Creating Value Leveraging Knowledge</small>	FORM	Document #: FMCD2005	Rev: 1.0
	ISO 9001: 2008 – BVBCET		
Department of Electrical & Electronics Engineering			

Course Code: 19EEEE301	Course Title: CMOS VLSI Circuits	
L-T-P: 3-0-0	Credits: 3	Contact Hrs: 40
ISA Marks: 50	ESA Marks: 50	Total Marks: 100
Teaching Hrs: 40		Exam Duration: 3 hrs

Content	Hrs
Unit – 1	
Chapter No. 1. Introduction to VLSI and IC fabrication technology VLSI Design Flow, Semiconductor Technology - An Overview, Czochralski method of growing Silicon, Introduction to Unit Processes (Oxidation, Diffusion, Deposition, Ion-implantation), Basic CMOS technology - Silicon gate process, n-Well process, p-Well process, Twin-tub Process, Oxide isolation.	06 hrs
Chapter No. 2. Electronic Analysis of CMOS logic gates DC transfer characteristics of CMOS inverter, Beta Ratio Effects, Noise Margin, MOS capacitance models. Transient Analysis of CMOS Inverter, NAND, NOR and Complex Logic Gates, Gate Design for Transient Performance, Switch-level RC Delay Models, Delay Estimation, Elmore Delay Model, Power Dissipation of CMOS Inverter, Transmission Gates & Pass Transistors, Tristate Inverter.	14 hrs
Unit – 2	
Chapter No. 3. Design of CMOS logic gates Stick Diagrams, Euler Path, Layout design rules, DRC, Circuit extraction, Latch up – Triggering Prevention.	06 hrs
Chapter No. 4. Designing Combinational Logic Networks Gate Delays, Pseudo nMOS, Clocked CMOS, Dynamic CMOS Logic Circuits, Dual-rail Logic Networks: CVSL, CPL.	08 hrs
Unit – 3	
Chapter No. 5. VLSI Design Flow Structured Design Strategies: Hierarchy, Regularity, Modularity, Locality, SDEF Layout Flow, Case Study IC tape out.	06 hrs

Text Books (List of books as mentioned in the approved syllabus)

1. John P. Uyemura, Introduction to VLSI Circuits and Systems, 1, Wiley, 2007
2. Neil Weste, David Harris & Ayan Banerjee, CMOS VLSI Design, 3, Pearson Ed, 2005
3. Sung-Mo Kang & Yusuf Leblebici, CMOS Digital Integrated Circuits: Analysis and Design, 3, Tata McGra, 2007

References

1. Wayne, Wolf, Modern VLSI design: System on Silicon, 3, Pearson Ed, 2005
2. Douglas A Pucknell and Kamran Eshraghian, Basic VLSI Design, 3, PHI, 2005
3. Phillip. E. Allen, Douglas R. Holberg, CMOS Analog circuit Design, 1, Oxford University, 2002

 KLE Technological University <small>Creating Value Leveraging Knowledge</small>	FORM	Document #: FMCD2005	Rev: 1.0
	ISO 9001: 2008 – BVBCET		
Department of Electrical & Electronics Engineering			

Course Code: 19EEEE302	Course Title: Battery Management Systems	
L-T-P: 3-0-0	Credits: 3	Contact Hrs: 40
ISA Marks: 50	ESA Marks: 50	Total Marks: 100
Teaching Hrs: 40		Exam Duration: 3 hrs
Content		Hrs
Unit - 1		
Chapter No. 1. Introduction: Introduction to electric vehicle & hybrid electric vehicle, types of batteries and their specific applications, Lithium-ion battery fundamentals: Battery Operation, Battery Construction, Battery Chemistry, Safety, Longevity, Performance, and Integration. (introduction to broad spectrum of batteries)		03 hrs
Chapter No. 2. Battery Models: Battery Models, Overview, self-Discharge Modeling and parameter identification using SOC/OCV , Thevenin Equivalent Circuit, Hysteresis, Coulombic Efficiency, Nonlinear Elements		4 hrs
Chapter No. 3. BMS (Black-box approach): Need for BMS, Typical inputs, typical outputs and typical functions Battery management system network in a typical electric vehicle		2 hrs
Chapter No. 4. BMS Architectures: Monolithic, Distributed, Semi-Distributed, Connection Methods, Additional Scalability, Battery Pack Architectures		2 hrs
Chapter No. 5. System Control: Contactor Control, Soft Start or Precharge Circuits, Control Topologies, Contactor Opening Transients, Chatter Detection, Economizers, Contactor Topologies, Contactor Fault Detection		4 hrs
Unit - 2		
Chapter No. 6. Data acquisition (Measurement): Cell voltage, current and temperature measurement, Synchronization of Current and Voltage (5 hrs)		5 hrs
Chapter No. 7. Battery Management System Functionalities: CC/CV Charging Method, Target Voltage Method, Constant Current Method, Thermal Management, and Operational Modes.		3 hrs
Chapter No. 8. Charge Balancing(Cell balancing): Charge Balancing Strategies, Balancing Optimization, Charge Transfer Balancing, Flying capacitor		5 hrs
Chapter No. 9. SoC Estimation: Columb counting, SoC corrections, OCV measurements, temperature compensation		2 hrs
Unit - 3		
Chapter No. 10. BMS communications: Overview, Network Technologies ,I2C/SPI, RS-232 and RS-485 134, Local Interconnect Network, CAN 136 ,Ethernet and TCP/IP ,Modbus ,FlexRay, Network Design		5 hrs
Chapter No. 11. Battery Safety: Functional Safety, Hazard Analysis, Safety Goals, Safety Concepts and Strategies, Reference Design for Safety.		5 hrs

Text Books

1. Phillip Weicker "A Systems Approach to Lithium-Ion Battery Management" 2013, Artech house publisher

References

1. Jiuchun Jiang and Caiping Zhang, "Fundamentals and Applications of Lithium-Ion Batteries in Electric Drive Vehicles", John Wiley & Sons, 2015

 KLE Technological University Creating Value Leveraging Knowledge	FORM ISO 9001: 2008	Document #: FMCD2005	Rev: 1.0			
				Department of Electrical & Electronics Engineering		
				Syllabus		

Course Title: Power Electronics & Drives Lab		Course Code: 20EEEP301
L-T-P: 0-0-1	Credit: 1	Contact Hours: 2hrs/week
CIE Marks: 80	SEE Marks: 20	Total Marks: 100
Laboratory Hours: 2hrs	Exam Duration: 2 hrs	

Expt. No.	List of Experiments
Demonstration	
1.	Introduction to SciAmble workbench software
2.	Generation of PWM pulses
3.	Rapid Control Prototyping (RCP) using Model Based Design software
Exercise	
1.	Characterization of a DC motor.
2.	DC motor speed control
3.	Four Quadrant Operation of the DC Motor
4.	Volts/Hertz control of three-phase induction motor.
Structured Enquiry	
1.	To design and mathematically model the DC/IM drive. Experimentally verify the operability of the controller design using workbench.

 KLE Technological University Creating Value Leveraging Knowledge	FORM ISO 9001: 2008	Document #: FMCD2005	Rev: 1.0
Department of Electrical & Electronics Engineering			
Syllabus			

Laboratory Title: Automotive Electronics Lab
Total Hours: 36 Hrs
Total Exam Marks: 100

Lab. Code: 17EEEP305
Duration of Exam: 03 Hrs
Total CIE. Marks: 80

Sl. No.	Name of Experiment
Demonstration Experiment	
1	Electronic engine control system: Injection and Ignition control system, Transmission trainer modules
Exercise Experiment	
2	Simulation of an automobile engine
3	Modeling a vehicle motion on a flat surface during hard acceleration, deceleration and steady acceleration.(ABS and suspension system)
4	Basic gate logic simulation and modeling using Simulink and realization on the hardware platform.
5	Modeling Seat belt warning system, and Vehicle speed control based on the gear input.
6	EGAS modeling and simulation using Simulink and realization on the hardware platform.
7	Interior lighting control modeling with state flow
8	Gear input transmission over CAN bus using ARM Cortex m3 and signal analysis using CANalyzer/BusMaster software. Code driven and Model driven integration for Vehicle speed control function based on the gear input.
Structured Enquiry	
1	Develop Matlab code for stepper motor control and convert it to Simulink model and port it on to an embedded hardware
2	Develop a C code for LCD display device and convert it to Simulink model and port it to embedded hardware/FPGA

 KLE Technological University Creating Value Leveraging Knowledge	FORM ISO 9001: 2008	Document #: FMCD2005	Rev: 1.0			
				Department of Electrical & Electronics Engineering		
				Syllabus		

Laboratory Title: Minor Project

Lab. Code: 17EEEW302

Total Hours: 36

Duration of SEE Hours: 3

SEE Marks: 50

CIE Marks: 50

Students are supposed to carry out the minor project based on the theme and guidelines as given below.

(I) Theme:

Hardware Design and Implementation of Electrical and / or Electronics System for application in Controls, Measurement and Instrumentation, Power Electronics and Drives, Relays, Renewable Energy Systems etc using specialized ICs /Microcontrollers /DSPs.

(II) Project batches and Guide:

Each project batch consists of 3 or 4 students. Students are informed to form their own batch based on the kind of project work and their interest. Each batch is supposed to give four faculty names as guides in the order of their preference. Guides will be allocated based on the preference given by the batch. The primary role of the guide is to supervise the work, provide appropriate guidance in successfully carrying out the project work.

(III) Project implementation

The principle steps in carrying out the project work are summarized below:

Step-1: Literature survey:

A literature survey with regard to the given theme is to be carried out in order to understand the state of the current research. Further, a critical review of the collected literature will facilitate to summarize key observations. Key observations will lead to identifying a specific problem for the project work in terms of alternate/new solution techniques, possible improvements, new formulations or models, hardware implementations etc.

Step-2: Prepare a synopsis:

A synopsis highlights the definition of identified problem and its significance. The synopsis will also contain detailed literature review giving the state of the current research on the selected specialized area. It will also brief the problem formulation, solution methodology, tools employed and possible outcomes.

Step-3: Project implementation:

The work is to be carried out in phase wise manner, testing or analyzing the partial results obtained. Guide will periodically monitor the progress of the work done giving suitable suggestions as required.

(IV) Schedule:

Sl. No.	Activity	Week No.	Evaluation Objectives
1	Announcement for the formation of batches	At the end of the previous semester	NA
2	Allotment of guides	1 st - 2 nd	NA
3	Submission of Synopsis	3 rd - 5 th	Literature review, problem formulation, solution methodology, tools employed
4	Review-I	6 th - 8 th	Literature review, problem formulation, solution methodology, tools employed
5	Review-II	9 th -10 th	Analysis and implementation (partial)
6	Review-III	12 th - 14 th	Analysis, complete implementation and results.

	KLE Technological University Creating Value Leveraging Knowledge	FORM ISO 9001: 2008	Document #: FMCD2005	Rev: 1.0
Department of Electrical & Electronics Engineering				
Syllabus				

Evaluation:

Evaluation of the project work carried out by each batch will be reviewed periodically by a review committee. Review committee consists of guide and two other faculty members who are guiding other batches. Generally, two to three reviews will be held during a semester. However, each project batch will be supervised by the guide on a weekly basis. Review committee will evaluate for 40% and guide will evaluate for 60% of the total marks.

Continuous Internal Evaluation (50%)	Assessment	Marks
	Evaluation by Project Guide	30
	Project Review committee	20
Semester End Examination (50%)	Using SEE Rubrics	50
	Total	100

Passing: 40% both in CIE and SEE

 KLE Technological University Creating Value Leveraging Knowledge	FORM ISO 9001: 2008	Document #: FMCD2005	Rev: 1.0
	Department of Electrical & Electronics Engineering		
	Syllabus		

Course Code:17EEEC401

Course Title: Switched Mode Power Converters

L-T-P-SS: 3-0-0

Credits: 3

Contact Hrs: 40

CIE Marks: 50

SEE Marks: 50

Total Marks: 100

Teaching Hrs: 40

Exam Duration: 3 hrs

Chapter No.	Unit-I	
1	Chapter No. 1.DC Power Supplies: Introduction, transformer models, the flyback converter: Continuous Current Mode, Discontinuous Current Mode, Summary of flyback converter operation, the forward converter, summary of forward converter, operation, the doubly ended (two switch)forward converter, the push-pull converter, summary of push-pull converter operation, full-bridge and half-bridge DC-DC converters, multiple outputs, converter selection, power factor correction, simulation of DC power supplies, pwm control circuits, the Ac line filter, the complete DC power supply .	15 hrs
	Unit-II	
2	Chapter No. 2. DC-AC Switched Mode Inverters Introduction, basic concepts of switch-mode inverters, single phase inverters, three phase inverters, effect of blanking time on output voltage in inverters, other inverter switching schemes, rectifier mode of operation.	15 hrs
	Unit-III	
3	Chapter No. 3. Multilevel Converters: Introduction, Generalized topology with a Common DC Bus, Converters Derived from the Generalized Topology, Diode Clamped Topology, Flying Capacitor Topology,	05 hrs
4	Diode Clamped Multilevel Converters: Introduction, Converters structure and Functional description: voltage clamping, switching logic, Modulation of multilevel converters, Multilevel space vector modulation	05 hrs

Text Books

- 1 Ned Mohan, T. M. Undeland and W. Robbins, Power Electronics: Converters, Applications and Design, 2, John Wiley and Sons, 1995
- 2 Daniel W Hart, Power Electronics, 1, Tata McGRAW-HILL, 2011
- 3 YorkSergio Alberto González, Santiago Andrés Verne, María Inés Valla, Multilevel converters for Industrial Applications, CRC Press, 2014 .

Reference Books:

- 1 Rashid M. H, Power Electronics: Circuits, Devices and Applications, 3, PHI, 2005
- 2 Bose B. K., , Power Electronics and AC Drives, 5, PHI, 2003
- 3 Rashid M. H, Digital Power Electronics and Applications, 1, Elsevier, 2005
- 4 V. Ramanarayanan, Switched Mode Power Converters Notes, IISC, Bangalore, 2008

 KLE Technological University Creating Value Leveraging Knowledge	FORM ISO 9001: 2008	Document #: FMCD2005	Rev: 1.0			
				Department of Electrical & Electronics Engineering		
				Syllabus		

Course Code: 21EEEE402	Course Title: AUTOSAR	
L-T-P : 3-0-0-0	Credits: 3	Contact Hrs: 3 Hours
ISA Marks: 50	ESA Marks: 50	Total Marks: 100
Teaching Hrs: 40		Exam Duration: 3

Content	Hrs
Unit - 1	
Chapter No. 1: AUTOSAR Fundamentals Evolution of AUTOSAR – Motivations and Objectives AUTOSAR consortium – Stake holders – work Packages, AUTOSAR Partnership, Goals of the partnership, Organization of the partnership, AUTOSAR specification, AUTOSAR Current development status, BSW Conformance classes: ICC1, ICC2, ICC3, and Drawbacks of AUTOSAR.	8 hrs
Chapter No. 2: AUTOSAR layered Architecture AUTOSAR Basic software, Details on the various layers , Details on the stacks Virtual Function Bus (VFB) Concept Overview of AUTOSAR Methodology , Tools and Technologies for AUTOSAR AUTOSAR Application Software Component (SW-C) ,Types of SW-components AUTOSAR Run Time Environment (RTE): RTE Generation Process: Contract Phase, Generation Phase, MCAL, IO HW Abstraction Layer, Partial Networking, Multicore, J1939 Overview, AUTOSAR Ethernet, AUTOSAR E2E Overview , AUTOSAR XCP, Metamodel , From the model to the process , Software development process.	7 hrs
Unit - 2	
Chapter No. 3: Methodology of AUTOSAR and Communication in AUTOSAR CAN Communication, CAN FD, CANape, Application Layer and RTE, intra and inter ECU communication, Client-Server Communication, Sender-Receiver, Communication, CAN Driver, Communication Manager (ComM), Overview of Diagnostics Event and Communication Manager	10 hrs
Chapter No. 4: Overview about BSW constituents BSW Constituents: Memory layer, COM and Services layer, ECU abstraction, AUTOSAR, Operating system, Interfaces: Standard interface, AUTOSAR standardized interface, BSW-RTE interface,(AUTOSAR interface), BSW-ECU hardware interface, Complex device drivers and BSW module configuration, AUTOSAR Integration.	5 hrs
Unit - 3	
Chapter 5: MCAL and ECU abstraction Layer Microcontroller Drivers, Memory drivers: on-chip and off chip drivers, IO drivers(ADC, PWM, DIO), Communication drivers: CAN driver, LIN drivers, Flexray	5 hrs
Chapter 6: Service Layer Diagnostic Event Manager, Function inhibits Manager, Diagnostic communication manager, Network management, Protocol data unit router, Diagnostic log and trace unit, COMM manager.	5 hrs

	KLE Technological University <small>Creating Value Leveraging Knowledge</small>	FORM ISO 9001: 2008	Document #: FMCD2005	Rev: 1.0
Department of Electrical & Electronics Engineering				
Syllabus				

Text Book (List of books as mentioned in the approved syllabus)

1. Ribbens, Understanding of Automotive electronics, 6th Edition, Elsevier, 2003
2. Denton.T, Automobile Electrical and Electronic Systems, Elsevier, 3rd Edition, 2004
3. Denton.T, Advanced automotive fault diagnosis, 2000

References

1. Ronald K Jurgen, Automotive Electronics Handbook, 2nd Edition, McGraw-Hill, 1999
2. James D Halderman, Automotive electricity and Electronics, PHI Publication, 2000
3. Allan Bonnick, Automotive Computer Controlled Systems Diagnostic Tools and Techniques, Elsevier Science, 2001
4. Nicholas Navet , Automotive Embedded System Handbook , 2009

 KLE Technological University Creating Value Leveraging Knowledge	FORM ISO 9001: 2008	Document #: FMCD2005	Rev: 1.0			
				Department of Electrical & Electronics Engineering		
				Syllabus		

Course Title: Powertrain Control Laboratory		Course Code: 20EEEE402
L-T-P: 0-0-3	Credit:3	Contact Hours: 2hrs/week
CIE Marks:80	SEE Marks: 20	Total Marks:100
Laboratory Hours: 2hrs	Exam Duration:2 hrs	

Expt. No.	List of Experiments
Demonstration	
1.	Introduction to MATLAB Simulink
Exercise	
1.	Battery Modelling and simulation
2.	Mathematical modelling and simulation of power converters
3.	dq transformation theory
4.	Characterization of a three phase induction motor
5.	Induction motor drive
6.	PMSM Drive
7.	PMBLDC Drive
Structured Enquiry	
1.	System Integration and testing (End-to-end simulation)

 KLE Technological University <small>Creating Value Leveraging Knowledge</small>	FORM	Document #: FMCD2005	Rev: 1.0
	ISO 9001: 2008 – BVBCET		
Department of Electrical & Electronics Engineering			

Course Code: 17EEEE405	Course Title: Smart Grid Technologies	
L-T-P-SS: 3-0-0-0	Credits: 3	Contact Hrs: 40
CIE Marks: 50	SEE Marks: 0	Total Marks: 50
Teaching Hrs: 40		Exam Duration: 3 hrs

Chapter No.	Unit-I	
1	Chapter No. 1. Introduction to energy efficient smart grids Concept, Defining a perfect electric energy service system, Fully integrated power systems: Smart grids, Challenges in Smart grids implementation: Enabling Energy Efficiency, Overview of the technologies required for energy efficient smart grids.	4 hrs
2	Chapter No. 2. Communication technology in smart grids Communication requirements, Overview of smart grid standards, Wired and wireless Communication, Communication Networks: Wide area network, Neighborhood area networks, home are networks, Integration of Utility Communication Networks and Smart Devices, Cyber security, Interoperability, Case Studies	8 hrs
Unit II		
3	Chapter No. 3. Smart and Efficient Transmission System Transmission Blackouts: Risk, Causes and Mitigation and Case Studies, Phasor measurement unit, Phasor data concentrators, Wide Area Monitoring, Protection and Control, Energy Monitoring systems and its applications in Smart grids, Flexible AC and HVDC transmission system.	7 hrs
4	Chapter No. 4. Protocols and Standards in Smart systems International Electro-technical communication standards and benefits, BEE standards for Implementation of Energy Management System, GOOSE protocols for communication, IEC 61850 Substation model, Integration of Intelligent Electronic Devices in EMS, SCADA and Substation Automation Systems.	7 hrs
Unit III		
5	Chapter No. 5. Smart Distribution systems and Energy Storage Smart metering, Real time energy pricing, Smart appliances, Distributed Energy Resources in Smart Grids, Demand response, Energy Storage Devices: Battery storage, Plug in hybrid electric vehicles, Compressed air, Pumped hydro, Ultra capacitors, Fly wheels and Fuel cells	7 hrs
6	Chapter No. 6. Renewable Energy integration Carbon foot printing, Micro-grid architecture, Modeling PV and Wind systems, Tackling Intermittency, Issues of interconnection, Protection and control of Micro-grid and sustainability	7 hrs

 KLE Technological University <small>Creating Value Leveraging Knowledge</small>	FORM ISO 9001: 2008 – BVBCET	Document #: FMCD2005	Rev: 1.0
Department of Electrical & Electronics Engineering			

Text Books	
1	Janaka Ekanayake, Nick Jenkins, Kithsiri Liyanage Jianzhong, Wu Akihiko Yokoyama, Smart Grid : Technology and Applications, 1st edition March 2012, Wiley.
2	Clark .W Gellings, The Smart Grid : Enabling Energy Efficiency and Demand Response, Published by The Fairmont Press, CRC Press by Taylor and Francis Group, LLC
Reference Books:	
1	Stuart Borlase, Smart Grids(Power Engineering), 1, CRC press, 2012
2	Joao P.S. Catalao, Smart Grids and Sustainable Power Systems, CRC press, 2015 by Taylor and Francis Group, LLC
3	Bureau of Energy Efficiency: Standard Guide Books for Energy Auditors and Managers, Ministry of power, Govt. of Bhaarat.

 KLE Technological University <small>Creating Value Leveraging Knowledge</small>	FORM ISO 9001: 2008 – BVBCET	Document #: FMCD2005	Rev: 1.0
Department of Electrical & Electronics Engineering			

Course Code: 19EEEE401

L-T-P: 3- 0- 0

Course Title: **Flexible AC Transmission System (FACTS)**

CIE Marks: 50

Teaching Hrs: 40 hrs

SEE Marks: 50

UNIT I		Hrs
1.	FACTS: Concept and General System Considerations: Transmission Interconnection, Flow of power in AC system, Limits of loading capability, Power flow and dynamic stability consideration of a Transmission Interconnection, Relative importance of controllable parameters, and Basic types of FACTS controllers, Brief description and Definitions of FACTS controllers, Perspective: HVDC or FACTS	10 hrs
2.	Voltage Sourced Converters: Basic Concepts, Single Phase Full Wave Bridge Converter Operation, Single phase Leg operation, Three Phase Full Wave Bridge Converter, Transformer Connection for 12 pulse operation	05 hrs
UNIT II		
3.	Current Sourced Converters: Basic concepts, Three phase full wave diode rectifier, Thyristor based converter Rectifier operation with gate turn ON, Current sourced converter with turn OFF devices, Current sourced versus Voltage sourced converter.	05 hrs
4.	Objectives of Series and Shunt Compensation: Objective of Shunt Compensation, Methods of Controllable VAR Generation, Static VAR Compensators SVC STATCOM, Objective of Series Compensation, Static Series Compensators, GCSC, TSSC, TCSC and SSSC	10 hrs
Unit – III		
5.	Static Voltage, Phase Angle Regulators: Objectives of Static Voltage and Phase Angle Regulators, Approach to Thyristor Controlled Voltage and Phase Angle Regulators, TCVR and TCPAR,	05hrs
6.	Combined Compensators: Unified Power Flow Controller UPFC and Interline Power Flow Controller IPFC.	05hrs

Text Book:

1. Narain G. Hingorani, and Laszlo Gyugyi., “*Understanding FACTS*”, IEEE Press, Standard Publishers Distributors, Delhi, 200, ISBN 81 86308 79 2.

References Book:

1. K. R Padiyar, “*FACTS controllers in Power Transmission and Distribution*”, New Age International Publishers, New-Delhi, 2007, ISBN 978 81 224 2142 2.

 KLE Technological University Creating Value Leveraging Knowledge	FORM ISO 9001: 2008	Document #: FMCD2005	Rev: 1.0
	Department of Electrical & Electronics Engineering		
	Syllabus		

Laboratory Title: Power System Simulation Lab Lab. Code: 19EEEP401
Credits: L-T-P: 0-0-1 Credits: 1 Duration of SEE Hours: 2
SEE Marks: 20 CIE Marks: 80

Experiment wise Plan

List of experiments/jobs planned to meet the requirements of the course.

Category: Demonstration	
Expt./ Job No.	Experiment / Job Details
1	To use interactive simulation software “SoftTCAPS” for the simulation of (i) Load flow analysis by Gauss-Seidel and NR models (ii) Voltage control analysis by shunt capacitor and tap changing transformer (iii) P-V Curve at a load bus
2	To use interactive software "SoftTCAPS" for the simulation of Economic load dispatch problem with and without coordinating the transmission losses
Category: Exercise	
Expt./ Job No.	Experiment / Job Details
3	To form bus admittance matrix [Ybus] by singular transformation.
4	To form [Ybus] by the method of inspection
5	ABCD constants and line performance using short and medium π/Γ models
Category: Structured Enquiry	
Expt./ Job No.	Experiment / Job Details
6	Each batch (consisting of 4 students) will work on one problem from the below mentioned sets, obtain the simulation results, carry out the analysis, interpret the results, draw practical conclusions from them and prepare a report. (a) To formulate and develop MATLAB/Scilab program/ SIMULINK model on one of the power problem which include, but not limited to - Load frequency control method, Study to determine the effect of excitation on dynamic stability, Comparison of various numerical techniques for stability study, Multimachine transient stability study, Load flow model development, (b) To employ an interactive power system software to simulate a given problem such as multimachine transient stability, multimachine small signal stability, contingency analysis, performance comparison of various load flow models, economic load dispatch etc.

 KLE Technological University <small>Creating Value Leveraging Knowledge</small>	FORM ISO 9001: 2008 – BVBCET	Document #: FMCD2005	Rev: 1.0
	Department of Electrical & Electronics Engineering		

Laboratory Title: Relay & High Voltage Lab		Lab. Code: 20EEEP401
Total Hours: 32	Credits: L-T-P: 0-0-2 Credits: 2	Duration of SEE Hours: 2
SEE Marks: 20		CIE Marks: 80

Expt./ Job No. Experiment / Job Details		
Category: Exercise		
1	Introduction Session	2 hrs
2	To obtain the inverse time characteristics of a given fuse wire and wires of different lengths.	2hrs
3	To obtain the inverse time characteristics of an electromagnetic over current relay	2hrs
4	To obtain the operating characteristics of microprocessor based differential relay.	2hrs
5	To obtain the operating characteristics of microprocessor based directional over current relay.	2hrs
6	To obtain the breakdown strength of air using Copper sphere gap with HVAC and HVDC.	2hrs
7	a) To obtain the breakdown strength of air using different pairs of electrode gap with HVAC and HVDC. b) To obtain the breakdown voltage of a solid dielectric. c) To obtain the breakdown voltage of a liquid dielectric.	2hrs
Category: Structured Enquiry		
1.	To develop microcontroller based overcurrent, over voltage and impedance relay using CT /PT giving details of program and demonstrate it's working output.	4hrs

 KLE Technological University Creating Value Leveraging Knowledge	FORM ISO 9001: 2008	Document #: FMCD2005	Rev: 1.0			
				Department of Electrical & Electronics Engineering		
				Syllabus		

Laboratory Title: Senior Design Project	Lab. Code: <u>21EEEEW401</u>
Total Hours: 50	Duration of ESA Hours: 3
ESA Marks: 50	ISA Marks: 50

Senior Design Project Guidelines

(I) Preamble

A project work essentially gives the students a platform to integrate the concepts studied during the study, enhance their analytical capabilities and develop abilities to effectively communicate technical information in multiple formats. During the course of projects, students are asked to follow the research methodology in identifying a problem of their interest through literature survey, carry-out feasibility study, formulate the problem, develop mathematical models, select suitable solution technique etc. Students are also encouraged to develop new formulations, alternate solution techniques, study and apply new optimization algorithms, develop new simulation models and use modern engineering/simulation tools.

(II) Project batch and Guide

Each project batch consists of 3 or 4 students. Students will be informed to form their own batch based on the kind of project work and their interest. Each batch is supposed to give four faculty names as guides based on faculty expertise in the order of their preference. Guides will be allocated based on the preference given by the batch. The primary role of the guide is to supervise the work, give appropriate guidance in successfully carrying out the project work.

(III) Project implementation

The principal steps in carrying out the project work are summarized below:

Step-1: Selection of a specialized area for the project work

A specialized area in which the project work is to be carried out depends on the interest and specialized skills acquired by the project team. This includes areas such as power system analysis, power system dynamics, renewable energy, electric drives, VLSI & Embedded system, Power quality issues etc. The proposed work may include simulation studies, hardware implementation or both.

Step-2: Selection of topic based on literature survey

A literature survey in the selected specialized area is to be carried out in order to understand the state of the current research. Further, a critical review of the collected literature will facilitate to summarize key observations. Key observations will lead to identifying a specific problem for the project work in terms of alternate/new solution techniques, possible improvements, new formulations or models, hardware implementations etc.

 KLE Technological University Creating Value Leveraging Knowledge	FORM ISO 9001: 2008	Document #: FMCD2005	Rev: 1.0			
				Department of Electrical & Electronics Engineering		
				Syllabus		

Step-3: Prepare a synopsis

A synopsis highlights the definition of identified problem and its significance. The synopsis will also contain detailed literature review giving the state of the current research on the selected specialized area. It will also brief the problem formulation, solution methodology, tools employed and possible outcomes.

Step-4: Project implementation

The work is to be carried out in phase wise manner, testing or analyzing the partial results obtained. Guide will periodically monitor the progress of the work done giving suitable suggestions as required.

(IV) Schedule

Sl. No.	Activity	Week No.	Evaluation Objectives
1	Announcement to form the batches	At the end of the previous 7 th sem	NA
2	Allotment of guides	1 st - 2 nd	NA
3	Submission of Synopsis	4 th - 5 th	Literature review, problem formulation, methodology by respective Guides
4	Review-I	6 th - 8 th	Literature review, problem formulation, methodology, tools used in the presence Review Committee
5	Review-II	9 th - 10 th	Implementation and analysis done
6	Review-III	12 th - 14 th	Completion along with Hardware/ Software/ Report. Results and Conclusions.

(V) Evaluation

Evaluation of the project work carried out by each batch will be reviewed periodically by a review committee. Review committee consists of guide and two/ three other faculty members who are guiding other batches. Generally, two to three reviews will be held during a semester. However, each project batch will be supervised by the guide on a weekly basis. Review committee will evaluate for 40% and guide will evaluate for 60% of the total marks.

	KLE Technological University Creating Value Leveraging Knowledge	FORM ISO 9001: 2008	Document #: FMCD2005	Rev: 1.0
Department of Electrical & Electronics Engineering				
Syllabus				

Activity	Assessment	Marks
ISA (50%)	Project Review committee	30
	Evaluation by Project Guide	20
ESA (50%)	Using ESA Rubrics	50
	Total	100

Passing: 40% both in ISA and ESA

 KLE Technological University Creating Value Leveraging Knowledge	FORM ISO 9001: 2008	Document #: FMCD2005	Rev: 1.0			
				Department of Electrical & Electronics Engineering		
				Syllabus		

Course Title: Research Experience for undergraduates	Course Code: 17EEEE490
L-T-P: 0-0-6	Duration of ESA: 1hr
ESA Marks: 50	CIE Marks: 50

REU courses

Course on Research Methodology (RM)

Sl no.	Topic	Time
1	Overview of course on research methodologies	2 hrs (First week)
1	How to carry out literature review	3 hrs (First week)
2	Problem definition/formulation Data Interpretation	2 hrs (First week)
3	Research Design	2 hrs (First week)
4	Report writing	1hrs (Mid of summer sem)
5	Paper writing	1hrs (Mid of summer sem)

Details of Phases of REU Courses

Sl No.	Phases	Reviews	Items to be reviewed	Outcome Elements	Max Marks	CLO	BL
1	Phase-1 During summer semester	Review-1 Before the end of 2 week	Idea-Generation: Literature survey, (familiarity of the problem), different solutions, Tool learning, expt setup, requirement analysis and RoadMap	1.1.4, 2.1.2, 2.4.1, 3.1.3, 4.1.1, 4.2.1, 4.3.1, 5.2.1, 5.3.1, 6.1.1, 6.2.2, 8.2.2, 10.1.1, 12.3.1	25	1,2	4,5
		Review-2 Before the end of 6 week	Procedures/Design Phase Implementation - p1	2.1.2, 2.4.1, 3.1.3, 4.1.1, 4.2.1, 4.3.1, 5.2.1, 5.3.1,	25	3,4	4,5

 KLE Technological University Creating Value Leveraging Knowledge	FORM ISO 9001: 2008	Document #: FMCD2005	Rev: 1.0			
				Department of Electrical & Electronics Engineering		
				Syllabus		

				6.1.1, 8.2.2, 10.1.1, 11.1.1 13.1.1	6.2.2,			
		Review-3 End of the semester	Implementation -p2 continuation with the course	2.1.2, 3.1.3, 4.2.1, 5.2.1, 5.3.1, 6.1.1, 8.2.2, 10.1.1, 11.1.1 13.1.1	2.4.1, 4.1.1, 4.3.1,	25	3,4,5	4,5,6
2	Phase-2 During odd semester	Review-4	Demonstration of results, report writing, presentation, paper writing	1.1.4, 2.4.1, 4.2.1, 5.2.1, 5.3.1, 9.1.1, 10.1.1, 12.3.1 14.1.1 14.1.2	2.1.2, 4.1.1, 4.3.1,	25	3,4,5,6	4,5,6
3	Phase-3 End of the odd semester	Viva-voce At the beginning of 8 th semester	Viva-voce with the external examiner			100		

Evaluation Rubrics

Name of the student:

Name of the guide/s:

Name of the committee members:

Note:

1. For the final grading total marks are normalized to 100: 50% (50 from 100) marks from the CIE and 50% (50 from 100) marks from SEE shall contribute.
2. 20% of CIE (20 marks from 100) are from course on research methodology.
3. Review committee shall be appointed by DUGC with HOD/HOS as chairman.

 KLE Technological University Creating Value Leveraging Knowledge	FORM ISO 9001: 2008	Document #: FMCD2005	Rev: 1.0		
				Department of Electrical & Electronics Engineering	
				Syllabus	

4. Use the REU style file already given to the students
5. Evaluate the contribution as weak (W), moderate (M) and strong (S).

Sl. no.	Reviews	Details		Contribution	Remarks
1	Course on RM (20)	3 Assignments			
Phase-1 Summer sem CIE-50M	Review -I (10 M), by guide	Problem Formulation	Literature survey		
			Identify gaps		
			Problem definition		
	Pre-requisites	Requirements			
		Demonstration of ability to use the tools/expt. setup			
		Planned activity chart			
Review-II (10 M) by guide /s	Review of implementation-p1				
Review-III (20 M) by committee	Committee review to decide continuation of the registration				
Phase-2 7 th sem CIE-50M	Review-IV (20M) by guide/s	Review of implementation-p2			
	Review-V(20M) by committee	Demonstration of results, report writing, paper writing and presentation			
Phase-3 SEE	Dissertation (50 M) By guide/s	Citations,			
	Viva-voce(50 M) External +guide/s				
	Total: 200Marks				

 KLE Technological University Creating Value Leveraging Knowledge	FORM ISO 9001: 2008	Document #: FMCD2005	Rev: 1.0			
				Department of Electrical & Electronics Engineering		
				Syllabus		

Laboratory Title: Institutional Research Project (IRP)	Lab. Code: 21EEEE491
Total Hours: 75hrs	Duration of exam: 2 hours
Total Exam Marks: 100	ISA Marks: 50

Guidelines for selection of a project:

- Researchers from the University apply for the research funding individually or in collaboration with national importance institutions to the agencies like DST, AICTE, VGST, DRDO, Agriculture Universities, industries. Faculty also apply for institutional funding to carry out research to provide an engineering solution for a societal problem.
- Once funding is confirmed, the Research and Development cell release Call For Participation (CFP) across the campus mentioning the details of all IRP/SRP/ISP.
 - Applications are scrutinized by the IRP/SRP/ISP team and an eligible team of students is allocated with the sub-module of the project.
 - Time plan: Research work worth of 60-70Hrs per team is assigned, including capacity building of individual members (80-100 Hrs) and teamwork (60-75hrs).

Criteria for group formation:

- 3-4 students in a team.
- Role of teammates: Team lead and members.

Allocation of Guides/ Mentors for the projects:

IRP/SRP/ISP faculty team will mentor the students' team

Role of a Guide/ Mentor

The primary responsibility of the mentor is to help students to understand the meaning and need of various stages in the implementation of the project. At every stage of the project development, a mentor should help towards its successful completion as per the predefined standards.

How student should carry out a project:

- Define the problem.
- Specify the requirements.
- Specify the design in an understandable form (Block Diagram, Flowchart, Algorithm, etc).
- Analyze the design and identify hardware and software components separately.
- Select appropriate simulation tool and development board for the design.
- Implement the design.
- Optimize the design and generate the results.
- Result representation and analysis.
- Prepare a document and presentation.

 KLE Technological University Creating Value Leveraging Knowledge	FORM ISO 9001: 2008	Document #: FMCD2005	Rev: 1.0			
				Department of Electrical & Electronics Engineering		
				Syllabus		

Report Writing

- The format for report writing should be downloaded from <ftp://10.3.0.3/projects>
- The report needs to be shown to guide and committee for each review.

Evaluation Scheme

- Internal semester assessment (ISA)
- Evaluation is done based on the evaluation parameters and rubrics given in Table 1, and Table 2 respectively.
- The progress of the project is reviewed and evaluated by the concerned team.

Table 1: Evaluation parameters for ISA

Reviews	Stages of projects	Parameters	Outcome Elements	Max Marks	Marks obtained
Review 1 (20M)	Initiation	Need analysis and Identification of problem	5.1.1	3	
		Problem relating socio economic context	7.1.2	3	
		Problem definition and application	6.1.1	3	
		Identifying multiple solutions, selecting the best suited solution and justifications with support of technical literature	10.1.1	5	
		Identify the standards and like IEEE& ACM Professional code of conduct	6.2.2 8.2.1	3	
		Identify limitations in the objectives and sources of error	2.4.3	3	
Review 2 (20M)	Planning	Project Planning (Gantt chart) and WBS(Work Breakdown Structure)	9.3.1	3	
		Identify the individual task	11.3.1	3	
		Mathematical and physical model of a system	2.3.2	3	
		Collection of appropriate test data	4.3.1	3	
		Functional block diagram relating input & output	5.2.2	3	
		Simulation of the design using suitable open source	5.2.1	3	
		Verify the credibility of results w.r.to accuracy and limitations	5.3.2	2	

 KLE Technological University Creating Value Leveraging Knowledge	FORM ISO 9001: 2008	Document #: FMCD2005	Rev: 1.0
	Department of Electrical & Electronics Engineering		
	Syllabus		

Review 3 (40M)	Execution	Detailed block diagram with all hardware specifications	14.2.1	5	
		Detailed block diagram with all software specifications	14.2.2	5	
		Integrating the functional blocks, debugging details and partial demonstration of results	3.4.1	5	
		design and develop considering modern techniques under the constraints	14.2.2	5	
		Demonstrate the results	14.4.1	10	
		Plan for optimization	10.1.1	5	
		Draft copy of technical report	12.3.1	5	
Review 4 (20M)	Closure	Implementation, analysis and conclusion of the results (Pre optimization and post optimization discussion)	14.2.2	10	
		Report submission in Latex (as given in the format)	10.3.2	10	
		Budget for the project	11.3.2	7	
		Future improvement of the project	12.1.1	3	
		Deliver effective oral presentation	10.2.2	10	

Table 2: Evaluation Rubrics

Review	Sl. No	Description	Marks	Inadequate	Average	Admirable	Outstanding
				Up to 25%	Up to 50%	Up to 75%	Up to 100%
R1	1.	Need Analysis and identifying the problem.	5	Not done	Not well defined	Framed but not clear	Need analysis done.
	2.	Understanding of professional ethics Copyright, plagiarism.	5	Does not understands	Understands and not considered	Understands and considered	Understands thoroughly and planned to address
	3.	Problem definition and Application in the societal context.	5	The problem definition is not stated correctly.	Aware of the problem but objectives and scope not well defined.	Overall sound understanding of the problem and constraints.	Problem and scope are well defined to the proposed work.
	4.	Identifying multiple solutions and selecting the	5	Not developed	Developed few (min 3) alternate solutions.	Developed alternate	Developed alternate solutions and selection of



Department of Electrical & Electronics Engineering

Syllabus

		best-suited solution and justifications with support of technical literature.		alternate solution.		solutions but no evaluation.	optimal solutions.
R2	1	Project Planning (Gantt chart) and WBS(Work Breakdown Structure).	5	Work distribution is not done.	The leader identified, but work is not started	The leader identified, but work is not distributed properly.	The leader identified, and work has been distributed properly.
	2	Specification and identification of input & output.	5	Input and output are not identified.	Input and output are identified.	Input and output are identified but not according to specs.	Inputs, outputs are identified and are according to specs
	3	Functional block diagram relating. input & output	5	Incomplete functional block diagram	The functional block diagram is done but inputs outputs are not stated.	The functional block diagram is done but inputs and outputs are not clearly mentioned.	The functional block diagram is done with proper inputs and outputs are not clearly mentioned.
	4	Simulation of the design using any open source.	5	No results and no analysis	Partial results but no analysis.	Inadequate analysis	Desired results are obtained and analyzed.
R3	1	Detailed block diagram with all specifications/ algorithms	5	Incomplete block diagram	The functional block diagram is done but improper interconnections of the block.	The functional block diagram is done with proper interconnections of the block but not according to specs.	The functional block diagram is done with proper interconnections of blocks according to specs.
	2	Integrating the functional blocks, debugging details and Partial demonstration of results	5	Functional blocks are not identified. No results	Functional blocks are implemented but improper integrated Code/Simulation results are not proper.	Functional blocks are implemented with proper integration. Code/Simulation results are proper but unable to demonstrate.	Proper integration of functional blocks and debugging details are provided. Able to demonstrate the required result.

 KLE Technological University <small>Creating Value Leveraging Knowledge</small>	FORM ISO 9001: 2008	Document #: FMCD2005	Rev: 1.0
	Department of Electrical & Electronics Engineering		
	Syllabus		

	3	Plan and need for optimization	5	Not done	Partial	Incomplete	Done
	4	Draft a copy of the project report	5	Not done	Partial	Incomplete	Done
R4	1	Implementation, demonstration, and analysis of results.(Pre optimization and post-optimization discussion)	10	Design is incomplete in terms of specifications and sub-blocks. No results and no analysis	The design of sub-blocks is satisfactory, with partial results but no analysis.	Design is completed in line with the specifications required. Inadequate analysis.	Design is complete, with all functional blocks in working condition. Desired results are obtained and analyzed.
	2	Report submission in Latex (as given in the format)	10	Not followed the recommended format	Followed the format but the contents are not properly organized	Format and contents are satisfactory	The report is properly organized as per the recommended format.
	3	Budget for the project	10	Not done	Partial	Incomplete	Done
	4	Deliver an effective oral presentation	10	Not followed the recommended format	Followed the format but the contents are not properly organized	Format and contents are satisfactory	The report is properly organized as per the recommended format.

 KLE Technological University Creating Value Leveraging Knowledge	FORM ISO 9001: 2008	Document #: FMCD2005	Rev: 1.0		
				Department of Electrical & Electronics Engineering	
				Syllabus	

End Semester Evaluation (ESA)

A semester-end examination is done based on the rubrics given in Table 3. The semester-end examination includes submission of the project report, demonstration of the projects, and viva-voce conducted by the external and internal examiner. ESA carries 50% weightage of total marks of projects. The following assessment rubrics are followed to evaluate the student.

1	2			3	4		5
Write UP: (W) 10 Marks	Design methodology 20 Marks			Demonstration of results & analysis 10 Marks	Report, presentation & Viva 10 Marks		Total Marks (50)
Objectives, block diagram, operation, results and individual contribution	Design specifications 1. Mathematical /algorithmic 2. Physical	Concepts applied, Optimization techniques	Applications and limitations, Meeting societal/industrial /commercial needs	Representation and analysis of Results	Presentation skills, clarity & language usage	Clear & well organized report	
1.3.1	3.1.6	3.2.2	7.1.2	4.1.3	10.2.2	10.1.3	

 KLE Technological University <small>Creating Value Leveraging Knowledge</small>	FORM ISO 9001: 2008 – BVBCET	Document #: FMCD2005	Rev: 1.0
	Department of Electrical & Electronics Engineering		

Course Code: 19EEEE402	Course Title: Embedded Linux	
L-T-P: 0-0-3	Credits: 03	Contact Hrs: 03
ISA Marks: 50	ESA Marks: 50	Total Marks: 100
Teaching Hrs: 40		Exam Duration: 03 hrs

Content	Hrs
Unit - 1	
Chapter 01: Introduction to Embedded Linux: A Brief History of Linux -Benefits of Linux -Acquiring and Using Linux -Examining Linux Distributions - Devices and Drives in Linux-Components: Kernel, Distribution, Sawfish, and Gnome.	4 hrs
Chapter 02: Overview of Embedded Linux: Overview: Development-Kernel architectures and device driver model- Embedded development issues-Tool chains in Embedded Linux-GNU Tool Chain (GCC,GDB, MAKE, GPROF & GCONV)- Linux Boot process.	5 hrs
Chapter 03: System Management and user interface: Boot sequence-System loading, sys linux, Lilo, grub-Root file system-Binaries required for system operation-Shared and static Libraries overview-Writing applications in user space-GUI environments for embedded Linux system.	5 hrs
Unit - 2	
Chapter 04: File system in Linux: File system Hierarchy-File system Navigation -Managing the File system –Extended file systems- INODE-Group Descriptor-Directories-Virtual File systems- Performing File system Maintenance - Locating Files –Registering the File systems- Mounting and Unmounting –Buffer cache-/proc file systems-Device special files.	6 hrs
Chapter 05: Configuration: Configuration, Compilation & Porting of Embedded Linux-Examining Shells -Using Variables - Examining Linux Configuration Script Files -Examining System Start-up Files -Creating a Shell Script.	4 hrs
Chapter 06: Process management and Inter process communication: Managing Process and Background Processes -Using the Process Table to Manage Processes - Introducing Delayed and Detached Jobs - Configuring and Managing Services -Starting and Stopping Services -Identifying Core and Non-critical Services -Configuring Basic Client Services - Configuring Basic Internet Services –Working with Modules. IPC-Benefits of IPC- Basic concepts-system calls-creating pipes-creating a FIFO-FIFO operations- IPC identifiers-IPC keys-IPCS commands- Message queues-Message buffer-Kernel Ring Buffer semaphores-semtools-shared memory semtools- signals-sockets.	8 hrs
Unit - 3	
Chapter 07: Linux device drivers: Devices in Linux- User Space Driver APIs- Compiling, Loading and Exporting- Character Devices- Tracing and Debugging- Blocking and Wait Queues- Accessing Hardware- Handling Interrupts- Accessing PCI hardware- USB Drivers- Managing Time- Block Device Drivers- Network Drivers- Adding a Driver to the Kernel Tree.	8 hrs

 KLE Technological University Creating Value Leveraging Knowledge	FORM ISO 9001: 2008 – BVBCET	Document #: FMCD2005	Rev: 1.0
Department of Electrical & Electronics Engineering			

Text Books (List of books as mentioned in the approved syllabus)

1. Embedded Linux – Hardware, Software and Interfacing - Craig Hollabaugh, Addison-Wesley Professional, 2002
2. Embedded / Real-Time Systems: Concepts, Design and Programming Black Book, New ed (MISL-DT) Paperback – 12 Nov 2003.

References

3. Building Embedded Linux Systems, Karim Yaghmour, First edition, April 2003.
4. Embedded Linux- John Lombardo, Newriders.com

 KLE Technological University <small>Creating Value Leveraging Knowledge</small>	FORM	Document #: FMCD2005	Rev: 1.0
	ISO 9001: 2008 – BVBCET		
Department of Electrical & Electronics Engineering			

Course Code: 17EEEO402	Course Title: Artificial Intelligence (AI)	
L-T-P 3-0-0	Credits: 3	Contact Hrs: 40
ISA Marks: 50	ESA Marks: 50	Total Marks: 100
Teaching Hrs: 40		Exam Duration: 3 hrs

Unit – I		
1.	Introduction Introduction to AI, What is Intelligence? Characteristics of Intelligence Definitions of AI, History & Evolution of AI, Abilities of AI, Modeling of AI, Application of AI, Adv & Dis Adv of AI	07 hrs
2.	Problem Solving Problem, Problem Solving, Problem Characteristics, Control Strategies, Problem search strategies, Data Driven & Goal Driven search, State space search, Goal & Game trees, Problem tree and Problem Graph, AND/OR Graph	08 hrs
Unit – II		
3.	Knowledge and Representation Introduction, Definition and Importance of Knowledge, Knowledge based systems, Representation of Knowledge, Internal Representation, Propositional Logic(PL) First order Predicate Logic (FOPL) knowledge organization, knowledge manipulation, acquisition of knowledge	08 hrs
4.	Structured Representation Structured representation, Graphical representation, IS-ISPART Tree, Associative Network, Conceptual Graph, Linear Graph, Semantic Networks, Frames, Object Oriented Structure, Similarity Nets, Scripts	07 hrs
Unit – III		
5.	AI Programming languages AI programming languages, Introduction to LISP: elements of LISP, Introduction to PROLOG and other programming languages.	05 hrs
6.	Applications of AI Matching Techniques, Visual Image Processing, Pattern Recognition and Expert Systems.	05 hrs

Books	
1	"Introduction to Artificial Intelligence and Expert systems" by D.W Patterson, Printice Hall of India, 1992.
Reference Books:	
1	"Artificial Intelligence" by Rich Elaine & Kevin Knight, Tata Mc Graw Hill, 1991.
2	"Principles of Artificial Intelligence" by Nils J Nilson, Berlin Springer- Verlag, 1980

 KLE Technological University Creating Value Leveraging Knowledge	FORM ISO 9001: 2008	Document #: FMCD2005	Rev: 1.0
Department of Electrical & Electronics Engineering			
Syllabus			

Laboratory Title: Capstone Project	Lab. Code: 21EEEW402
Total Hours: 50	Duration of ESA Hours: 2
ESA Marks: 50	ISA Marks: 50

Capstone Project Guidelines

(I) Preamble

A project work essentially gives the students a platform to integrate the concepts studied during the study, enhance their analytical capabilities and develop abilities to effectively communicate technical information in multiple formats. During the course of projects, students are asked to follow the research methodology in identifying a problem of their interest through literature survey, carry-out feasibility study, formulate the problem, develop mathematical models, select suitable solution technique etc. Students are also encouraged to develop new formulations, alternate solution techniques, study and apply new optimization algorithms, develop new simulation models and use modern engineering/simulation tools.

(II) Project batch and Guide

Each project batch consists of 4 students. Students will be informed to form their own batch based on the kind of project work and their interest. Each batch is supposed to give four faculty names as guides based on faculty expertise in the order of their preference. Guides will be allocated based on the preference given by the batch. The primary role of the guide is to supervise the work, give appropriate guidance in successfully carrying out the project work.

(III) Project implementation

The principal steps in carrying out the project work are summarized below:

Step-1: Selection of a specialized area for the project work

A specialized area in which the project work is to be carried out depends on the interest and specialized skills acquired by the project team. This includes areas such as power system analysis, power system dynamics, renewable energy, electric drives, VLSI & Embedded system, Power quality issues etc. The proposed work may include simulation studies, hardware implementation or both.

Step-2: Selection of topic based on literature survey

A literature survey in the selected specialized area is to be carried out in order to understand the state of the current research. Further, a critical review of the collected literature will facilitate to summarize key observations. Key observations will lead to identify a specific problem for the project work in terms of alternate/new solution techniques, possible improvements, new formulations or models, hardware implementations etc.

 KLE Technological University Creating Value Leveraging Knowledge	FORM ISO 9001: 2008	Document #: FMCD2005	Rev: 1.0			
				Department of Electrical & Electronics Engineering		
				Syllabus		

Step-3: Prepare a synopsis

A synopsis highlights the definition of identified problem and its significance. The synopsis will also contain detailed literature review giving the state of the current research on the selected specialized area. It will also brief the problem formulation, solution methodology, tools employed and possible outcomes.

Step-4: Project implementation

The work is to be carried out in phase wise manner, testing or analyzing the partial results obtained. Guide will periodically monitor the progress of the work done giving suitable suggestions as required.

(IV) Schedule

Sl. No.	Activity	Week No.	Evaluation Objectives
1	Announcement to form the batches	At the end of the previous 7 th sem	NA
2	Allotment of guides	1 st - 2 nd	NA
3	Submission of Synopsis	4 th - 5 th	Literature review, problem formulation, methodology by respective Guides
4	Review-I	8 th	Literature review, problem formulation, methodology, tools used in the presence Review Committee
5	Review-II	13 th	Implementation and analysis done
6	Review-III	16 th	Completion along with Hardware/ Software/ Report. Results and Conclusions.

(V) Evaluation

Evaluation of the project work carried out by each batch will be reviewed periodically by a review committee. Review committee consists of guide and two/ three other faculty members who are guiding other batches. Generally, two to three reviews will be held during a semester. However, each project batch will be supervised by the guide on a weekly basis. Review committee will evaluate for 40% and guide will evaluate for 60% of the total marks.

	KLE Technological University Creating Value Leveraging Knowledge	FORM ISO 9001: 2008	Document #: FMCD2005	Rev: 1.0
Department of Electrical & Electronics Engineering				
Syllabus				

Activity	Assessment	Marks
ISA (50%)	Project Review committee	30
	Evaluation by Project Guide	20
ESA (50%)	Using ESA Rubrics	50
	Total	100

Passing: 40% both in ISA and ESA



M.Tech. Advanced Manufacturing Systems Curriculum Structure & I & II Semester Syllabus 2021 – 23 Batch



Semester: I M.Tech. (Advanced Manufacturing Systems)

No	Code	Course	Category	L-T-P	Credits	Contact Hours	ISA	ESA	Total	Exam Duration
1	20EAMC701	PLM Fundamentals	PC	2-0-0	2	02	50	50	100	3 hours
2	20EAMC702	Engineering Data Management	PC	3-0-0	3	03	50	50	100	3 hours
3	20EAMC703	Product Design and Development	PC	3-0-0	3	03	50	50	100	3 hours
4	20EAMC704	Enterprise Resource Planning - I	PC	3-0-0	3	03	50	50	100	3 hours
Elective 1										
5	20EAME701	Design for Additive Manufacturing	PE	3-0-0	3	03	50	50	100	3 hours
	20EAME702	Industrial Robotics								
	20EAME703	Supply Chain Management								
	20EAME704	Manufacturing Systems Simulation								
6	20EAMP701	Collaborative Design-Modeling Lab	PC	0-0-5	5	10	80	20	100	2 hours
7	20EAMP702	PLM Functional Lab	PC	0-0-3	3	06	80	20	100	2 hours
8	20EAMP703	ERP Functional Lab	PC	0-0-3	3	06	80	20	100	2 hours
TOTAL				14-0-11	25	36				

Note:L: Lecture T: Tutorials, P: Practical,ISA: In Semester Assessment, ESA: End Semester Assessment,
 PJ-Project, PC-Programme Core, PE-Programme Elective



Semester: II M. Tech. (Advanced Manufacturing Systems)

No	Code	Course	Category	L-T-P	Credits	Contact Hours	ISA	ESA	Total	Exam Duration
1	20EAMC705	PLM Advanced	PC	2-0-0	2	02	50	50	100	3 hours
2	20EAMC706	Enterprise Resource Planning - II	PC	3-0-0	3	03	50	50	100	3 hours
3	21EAMC701	Project Feasibility and Analysis	PC	3-0-0	3	03	50	50	100	3 hours
4	20EAMC708	Research Methodology	PC	2-1-0	3	04	100	-	100	-
Elective 2.										
5	20EAME705	Additive Manufacturing	PE	3-0-0	3	03	50	50	100	3 hours
	20EAME706	Manufacturing Systems and Automation								
	20EAME707	Manufacturing Execution Systems								
	20EAME708	Robust Design Optimization								
6	21EAMP701	PLM Advanced Lab	PC	0-0-3	3	06	80	20	100	2 hours
7	20EAMP705	ERP Technical Lab	PC	0-0-2	2	04	80	20	100	2 hours
8	20EAMP706	Product Automation Lab	PC	0-0-3	3	06	80	20	100	2 hours
9	20EAMW701	Mini Project	PC	0-0-3	3	06	50	50	100	2 hours
TOTAL				13-1-11	25	37				

Note:L: Lecture T: Tutorials, P: Practical,ISA: In Semester Assessment, ESA: End Semester Assessment,
 PJ-Project, PC-Programme Core, PE-Programme Elective



Semester: III M. Tech. (Advanced Manufacturing Systems)

No	Code	Course	Category	L-T-P	Credits	Contact Hours	ISA	ESA	Total	Exam Duration
1	20EAMI801	Industrial Training/Mini Project	PJ	0-0-10	10	30	50	50	100	2 hours
2	20EAMW801	Project Work Phase I	PJ	0-0-8	8	24	50	50	100	2 hours
TOTAL				0-0-18	18	54				

Note:L: Lecture T: Tutorials, P: Practical,ISA: In Semester Assessment, ESA: End Semester Assessment,
 PJ-Project, PC-Programme Core, PE-Programme Elective

NOTE:

- **Industrial Training:** The student shall undergo industrial training for a period of 08 weeks.
Preliminary Report Submission and Evaluation after 8th week of Industrial training to be carried out by the Joint evaluation by Internal Guide of the University and Industry mentor for 50 marks.
Final Report Submission and Evaluation after 9th week of Industrial training to be carried out by the Internal Guide of the university and a senior faculty of School/ External examiner.
- **Project Phase I:**
Problem formulation and submission of **Synopsis** within 10 weeks from the commencement of 3rd semester in consultation with Guide of Industry or internal guide from University, which shall be evaluated for 50 marks by the committee constituted by the Head of the School/Department comprising the guide, senior faculty of the department with Head as Chairman. Design methodology and Solution model need to be completed by 12 weeks and shall be evaluated by guide and external examiner with senior faculty / Head as chairman for 50 marks.
- **Project Phase I and Phase II must be a Research Project**
 Mini Project is independent of Project.
 Evaluation of ISA is based on Rubrics.



Semester: IV M.Tech. (Advanced Manufacturing Systems)

No	Code	Course	Category	L-T-P	Credits	Contact Hours	ISA	ESA	Total	Exam Duration
1	20EAMW802	Project Work Phase II	PJ	0-0-20	20	40	50	50	100	2 hours
TOTAL				0-0-20	20	40				

Note:L: Lecture T: Tutorials, P: Practical,ISA: In Semester Assessment, ESA: End Semester Assessment,
PJ-Project, PC-Programme Core, PE-Programme Elective

Project Work Phase I and Phase II must be a Research Project
Evaluation of ISA is based on Rubrics.



Course Code: 20EAMC701	Course Title: PLM Fundamentals	
L-T-P : 2-0-0	Credits: 2	Contact Hrs:2
ISA Marks: 50	ESA Marks: 50	Total Marks: 100
Teaching Hrs: 30		Exam Duration: 3 hrs

Content	Hrs
<p>1. The PLM Environment</p> <p>PLM overview, Background for PLM, Scope, PLM grid, PLM paradigm – Concepts and consequences, Strategic benefits, Operational benefits, Spread of PLM, Overcoming problems, Enabling opportunities, Challenges, Issues in the traditional environment, Product data issues, A complex changing environment.</p>	07
<p>2. PLM Basic Functionalities</p> <p>Collaborations and approvals, Structure of PLM business process services, Workspace, Folders, Routes, Issue management, Document management, IP classification, Need for IP protection, Parts and libraries, BOM management.</p>	04
<p>3. Organizational Change Management</p> <p>Relevance of OCM in PLM, Benefits of OCM, Incremental and transformational change, Prerequisites for CM, The importance of OCM in the PLM Environment, Participants in change, Generic issues with change, OCM activities in the PLM environment, Pitfalls of organizational change.</p>	06
<p>4. Project Management in PLM Environment</p> <p>Characteristics of projects, People in projects, Project phases, Project management knowledge area, Project management tools and templates, The importance of project management in PLM, Project reality in a typical company, Project management activities in PLM Initiatives, Pitfalls of project management, Top management role with project management.</p>	06
<p>5. PLM: A Key Enabler in Implementation of Industry 4.0</p> <p>Digital manufacturing, Industry 4.0 – A smart era, Action areas of Industry 4.0, PLM in Industry 4.0, Collaborations in Industry 4.0 via PLM, IP protection and BOM management in Industry 4.0 via PLM, Project and variant management in Industry 4.0 via PLM, Traceability requirements management in Industry 4.0 via PLM, Benefits of incorporating PLM in Industry 4.0, Challenges and future directions for PLM in Industry 4.0.</p>	07
<p>Reference Books:</p> <ol style="list-style-type: none"> 1. Stark John, "Product Lifecycle Management: 21st Century Paradigm for Product Realization", Springer, Third Edition, 2015 2. Chaudhery Mustansar Hussain & Paolo Di Sia, "Handbook of Smart Materials, Technologies, and Devices: Applications of Industry 4.0", Springer. First Edition, 2021 	



Course Code: 20EAMC702	Course Title: Engineering Data Management	
L-T-P : 4-0-0	Credits: 3	Contact Hrs: 4
ISA Marks: 50	ESA Marks: 50	Total Marks: 100
Teaching Hrs: 40		Exam Duration: 3 hrs

Content	Hrs
<p>1. Introduction and Overview of Embedded Product Design</p> <p>Background, Related Research and Research Problems, Structure of the Report, Design for Manufacture, Design of Embedded Products, Technical Design Disciplines and Document Management, Software Design, Electronics Design, Software-Hardware Co-Design, Mechanical design, Concurrent Engineering, Design Data Management.</p>	05
<p>2. PDM Systems and Data Exchange</p> <p>Product Data Management (PDM), State-of-the-art trends of PDM, Data Formats and Translators in Data Exchange, STEP (Standard for the Exchange of Product Model Data), CDIF (Case Data Interchange Format), SGML (Standard Generalized Markup Language).</p>	05
<p>3. PDM and SCM</p> <p>PDM and the Product Life Cycle, PDM Systems – Common Functionality, Product Structure and Document Management, System Architecture, Version Management, Configuration Selection, Concurrent Development, Build Management, Release Management, Workspace Management, Change Management.</p>	10
<p>4. PDM and SCM Requirements of Design Data Management</p> <p>Requirements for the Embedded Product's Design Data Management, Data Management, Process and Life-Cycle Management, Data Capture & Distribution, Support for Working Methods, Requirements for Enterprise-Level Design Data Management, Design Data Management Levels, The Design Data Management Features of Design Tools , Team-Level Design Data Management, Team-Level Design Data Management.</p>	10
<p>5. Analysis of Needs and Solutions</p> <p>Comparison of Principles, Comparison of Key Functionalities, Requirements and Needs, Analysis, Different Scenarios in an Integrated Environment, Possible Integrations, Examples of integrations.</p>	05
<p>6. Product Data in PLM Environment</p> <p>Relevance of Product Data in PLM, Product Data Across the Lifecycle, Tools to Represent Product Data, Data model diagrams, Reality in a Typical Company-Issues, Challenges and Objectives, Product Data Activities in the PLM Initiative-Product Data Improvement.</p>	05
<p>Reference Books:</p> <p>1. Jukka Kaariainen, Pekka Savolainen, Jorma Taramaa & Kari Leppala, Product</p>	



<p>Data Management (PDM) Design, exchange and integration viewpoints, VTT- Technical research centre of Finland, 2000.</p> <ol style="list-style-type: none">2. Rodger Burden PDM: Product Data Management Volume 1, Resource Publishing, 2003.3. Annita Persson Dahlqvist et.al, PDM and SCM - similarities and differences, The Association of Swedish Engineering Industries, 2001.	
---	--



Course Code: 20EAMC703	Course Title: Product Design & Development	
L-T-P : 3-0-0	Credits: 3	Contact Hrs: 3
ISA Marks: 50	ESA Marks: 50	Total Marks: 100
Teaching Hrs: 40		Exam Duration: 3 hrs

Content	Hrs
1. Introduction Characteristics of successful product development, duration and cost of product development, Challenges of product development.	06
2. Development Process and Organizations Generic development process, concept development – Front-end process, adapting the generic product development process.	06
3. Identifying Customer Needs Defining scope, gathering data from customers, establishing relative importance of needs etc.	06
4. Establishing Product Specifications Target specifications & refining specifications.	04
5. Concept Generation Five step methodology of concept generation.	04
6. Concept selection Structured methodology for selecting a concept using selection matrix & ranking of concepts.	04
7. Product Architecture Meaning & implication of product architecture.	02
8. Industrial Design Meaning of ID, & its impact, Aesthetic & Ergonomic considerations, ID process.	04
9. Design for Manufacturing DFM meaning, DFM Methodology.	02
10. Value Engineering and Product Design Definition of value, Value analysis job plan, creativity etc.	02
Reference Books: <ol style="list-style-type: none"> 1. Karl T Ulrich and Steven D Eppinger, Product design and development, Tata McGraw Hill Publication. 2. A. K. Chitale and R. C. Gupta, Product Design and Manufacturing, Prentice Hall India. 3. Bralla, James G., Handbook of Product Design for Manufacturing, McGraw Hill Publications. 	



Course Code: 20EAMC704	Course Title: Enterprise Resource Planning - I	
L-T-P : 3-0-0	Credits: 3	Contact Hrs: 3
ISA Marks: 50	ESA Marks: 50	Total Marks: 100
Teaching Hrs: 40		Exam Duration: 3 hrs

Content	Hrs
<p>1. Introduction to ERP</p> <p>Need for ERP, Characteristics and components of ERP, Suppliers of ERP, Integrated Management Information, Seamless Integration and Functional information system, Marketing, Accounting and Financial Management, Supply Chain Management, Resource Management, Integrated Data Model</p> <p>Business Functions and Business Processes: Functional Areas of Operation, Business Processes, A process view of business, Functional Areas and Business process of very small business. Marketing and Sales, Supply Chain Management, Accounting and Finance, Human Resources, Functional Area Information System</p> <p>Business Process Reengineering: Need for reengineering, Reengineering Model, BPR Guiding principles , Business process reengineering and performance improvement, Enablers of BPR in Manufacturing, Collaborative Manufacturing, Intelligent manufacturing, Production Planning. BPR Implementation</p>	10
<p>2. ERP – A Manufacturing Perspective</p> <p>Role of Enterprise Resource Planning (ERP) in manufacturing, Computer Aided Design/Computer Aided Manufacturing (CAD/CAM), Materials Requirement Planning (MRP)-Master Production Schedule (MPS);Bill of Material (BOM);Inventory Records; Closed Loop MRP; Manufacturing Resource Planning (MRP-II), Manufacturing and Production Planning Module of an ERP System , Distribution Requirements Planning (DRP), Just-in-Time(JIT) & KANBAN - Kanban; Benefits of JIT; Potential Pitfalls of JIT; Kanban, Product Data Management (PDM)- Data Management, Process Management; functions of PDM; Benefits of PDM, Manufacturing Operations- Make-to-Order (MTO) and Make-to-Stock (MTS); Assemble-to-Order (ATO); Engineer-to-Order (ETO); Configure-to-Order (CTO)</p>	10
<p>3. ERP modules structure</p> <p>Financial & Accounting Management: Differences between Financial accounting, Cost accounting and Management accounting, Basic finance – Concept of Cost Centre accounting, Cost – Volume – Profit Analysis, Cash Flow Analysis</p> <p>Sales and Distribution Perspective: Features of purchase module, ERP Purchase System; Role of ERP in Sales and Distribution, Sub-Modules of the Sales and Distribution Module: Master data management, Order management, Warehouse management, Shipping and transportation, Billing and sales support, foreign trade, Integration of Sales and Distribution Module with Other Modules</p> <p>Inventory Management Perspective: ERP inventory management system, Importance of Web ERP in Inventory Management, ERP Inventory Management</p>	20



Module and Sub-Modules of the ERP Inventory Management Module, Bill of Material, Safety stock, Lot number/Batch number, Inventory valuation methods

CRM Perspective: Role of ERP in CRM, Concept of CRM: Objectives of CRM; Benefits of CRM; Components of CRM, Types of CRM: Operational CRM, Analytical CRM, Sales intelligence CRM, Collaborative CRM, Sub-Modules of CRM: Marketing module; Service module; Sales module

HR Perspective: Role of ERP in Human Resource Management: Workflow of ERP human resource management system; Advantages of ERP human resource management system, Human Resource Management Module: Functions of human resource management module; Features of human resource management module; Benefits of human resource management module

Reference Books:

1. Ellen Monk & Bret Wagner, Concepts in Enterprise Resource Planning, 4th edition, Course Technology CENGAGE Learning.
2. Alexis Leon, Enterprise Resource Planning, 3rd edition, McGraw Higher Ed.
3. Vinod Kumar Garg, N.K. Venkitakrishnan, Enterprise Resource Planning: Concepts and Practice, 2nd edition, Prentice Hall India Learning Private Limited.
4. Sadagopan S., Enterprise Resource Planning: A Managerial Perspective, Tata McGraw Hill, New Delhi.
5. Pauline Weetman, Financial and Management Accounting: An Introduction, Pearson Education Limited.



Course Code: 20EAMP701	Course Title: Collaborative Design - Modeling Lab	
L-T-P : 0-0-5	Credits: 5	Contact Hrs: 10
ISA Marks: 80	ESA Marks: 20	Total Marks: 100
Teaching Hrs: 120		Exam Duration: 2 hrs

Content
<p>1. User Interface Platform Understand the user interface, Connect to the PLM platform, Access your Dashboard, Use the Tags for searching content, Share various documents with other users through, 3DSpace, Use standard menus and commands, Import new data and export to required file formats, Search for a 3D data using different methods, Explore and open 3D data, Manipulate the tree, Filter data</p>
<p>2. Sketcher Exercises on sketch tools, profile tool bar and constraint tool bar.</p>
<p>3. Part Design Exercise on 3D models using pad, slot, shaft, groove, hole, rib and stiffener commands, cut revolve etc.</p>
<p>4. Generative Shape Design (GSD) Exercises using GSD to generate complicate surfaces using sub tool bars</p>
<p>5. Sheet Metal Setting sheet metal parameters, bend extremities tab, creating the base wall, creating the wall on edge, creating extrusions etc.</p>
<p>6. Assembly Design Assembly design work bench Bottom-Up and Top-Down assembly approaches invoking existing components into assembly work exercise to demonstrate Top-Down assembly approach.</p>
<p>7. Drafting Converting existing 3D models into 2D drawings with all relevant details, sectional views etc.</p>
<p>8. Data Exchange and Collaborative Lifecycle Import and export different file formats, manage the Mastership of imported objects, Create a new product structure, Use different sections of the Action bar effectively, Manage the changes in a product structure, Save the product structure in the database</p>
<p>9. Design Review Create a design review, add markups to it, Create slides, and add markers, Create sections and measures, Export sections and measures, compare 3D Objects and 2D Drawings</p>
<p>Reference Books: Companion Courses – https://companion.3ds.com/</p>



Course Code: 20EAMP702	Course Title: PLM Functional Lab	
L-T-P : 0-0-3	Credits: 3	Contact Hrs:6
ISA Marks: 80	ESA Marks: 20	Total Marks: 100
Teaching Hrs: 72		Exam Duration: 2 hrs

Content	Hrs
<p>1. Collaboration and Approvals</p> <p>Illustrate the structure of PLM Business Process Services, Create and manage your folders, Create workflows, Identify and manage your assigned tasks, Subscribe to various objects and events, Report and resolve issues in objects, Create, track and organize your documents.</p>	15
<p>2. IP Classification</p> <p>Need for IP Classification, Create different types of libraries and their related hierarchies, Create and manage documents and parts, classify the library objects based on their features, Use the Classification functionality.</p>	15
<p>3. Change Management</p> <p>Initiate a change action, Add proposed changes to change action, Work under change actions to execute a design modification, View the realized changes, Review and approve the design changes.</p>	15
<p>4. Project Management Fundamentals</p> <p>Create programs and projects, Assign members to a project, Add tasks and assign project members to the tasks, Create folders for managing project documents, Create process flow for tasks, Review the status of programs and projects.</p>	15
<p>5. Open Ended Experiments</p> <p>Collaborations, IP Classification, Change management, Project management fundamentals</p>	12
<p>References:</p> <ol style="list-style-type: none"> 1. Companion Courses – https://companion.3ds.com/ 2. Antti Saakasvuori, Anselmi Immonen, "Product Lifecycle Management" - Springer, 1st Edition, 2003. 	



Course Code: 20EAMP703	Course Title: ERP Functional Lab	
L-T-P : 0-0-3	Credits: 3	Contact Hrs:6
ISA Marks: 80	ESA Marks: 20	Total Marks: 100
Teaching Hrs: 72		Exam Duration: 2 hrs

Content	Hrs
1. Selection Criteria for ERP Packages Survey of Indian ERP Packages.	02
2. Financial Accounting Basic Finance – Chart of accounts, Journal entries, Journal vouchers, Exchange rates; Banking (In and Out); Debit and Credit note.	16
3. Master Data Management Item master; Business partner master – Customer, vendor; Pricing; Tax.	06
4. Supply chain Management Sales: Sales quotation, Sales order, Delivery, Return, Invoice (A/R). Purchase: Purchase quotation, Purchase order, Return, GRN, Invoice (A/P). Production: Assembly BOM, Production order, Goods issue, Goods receipt.	38
5. Reports Generation of reports for various functional modules.	10
References: 1. SAP Business One Manual	



Course Code: 20EAME701	Course Title: Design for Additive Manufacturing	
L-T-P : 3-0-0	Credits: 3	Contact Hrs: 3
ISA Marks: 50	ESA Marks: 50	Total Marks: 100
Teaching Hrs: 40		Exam Duration: 3 hrs

Content
<p>1. Overview of Design for Additive Manufacturing (AM) How to design for AM? Challenges & opportunities, Design process, mechanical properties, performance of materials used in AM, process driven & designer driven shape, methods, Additive manufacturing principles & processes.</p>
<p>2. Drivers for AM Material efficiency, flow optimization, integration of functions, mass customization, lead time, automated manufacturing, Limitations, Available material, accuracy of the technology, price of the industrial machines, certification of materials and processes, surface finish(supports, post processing), part dimensions.</p>
<p>3. DFMA Principles for AM Maximum Part size, Faces requiring support, minimum wall thickness & rigidity, Minimum feature size & manufacturing quality, Typical geometries, DFX rules for additive manufacturing. Cost considerations.</p>
<p>4. Topology Optimization for AM Introduction to topology optimization, Topology optimization process, characteristics, link with AM potentials & Challenges, Current developments.</p>
<p>5. Accuracy Issues in AM Properties of metallic and nonmetallic additive manufactured surfaces, Stress induced in additive manufacturing (AM) processes. Surface roughness problem in rapid prototyping, Part deposition orientation and issues like accuracy, surface finish, build time, support structure, cost etc.</p>
<p>References:</p> <ol style="list-style-type: none"> 1. Ian Gibson, David W. Rosen, Brent Stucker, Additive manufacturing technologies: rapid prototyping to direct digital manufacturing, Springer, 2010. 2. Andreas Gebhardt, Understanding additive manufacturing: rapid prototyping, rapid tooling, rapid manufacturing, Hanser Publishers, 2011. 3. Christoph Klahn, Bastian Leutenecker, Mirko Meboldt, Design for Additive Manufacturing – Supporting the Substitution of Components in Series Products, Procedia CIRP 21 2014, 24th CIRP design conference 4. Rosen, D.W., 2007. Design for additive manufacturing: A method to explore unexplored regions of the design space. In Proceedings of the 18th Annual Solid Freeform Fabrication Symposium.



Course Code: 20EAME702	Course Title: Industrial Robotics	
L-T-P : 3-0-0	Credits: 3	Contact Hrs: 3
ISA Marks: 50	ESA Marks: 50	Total Marks: 100
Teaching Hrs: 40		Exam Duration: 3 hrs

Content
1. Robot fundamentals History of robotics, Advantages & Applications of robots, Robot characteristics. Classification and structure of robotic systems, PTP and continuous path systems, JIRA and RIA, Robot components, Robot anatomy (configurations, Robot motions), Work volume, drive systems
2. Robot kinematics Matrix representation, Homogeneous transformation matrices, Representation of transformations, Inverse transformation matrices, forward and inverse kinematics of robots, D-H representation of forward kinematic equations, degeneracy and dexterity
3. Differential motions and velocities Differential relationships, Jacobian, differential motions of a frame, calculation of Jacobian, inverse jacobian
4. Dynamic Analysis and forces Langrangian mechanics, Effective moments of inertia, Dynamic equations of multiple DOF robots, Static force analysis, Transformation of forces and moments between coordinate frames
5. Robot control systems Components, Basic control system concepts and models, Controllers, control system analysis, robot actuation and feedback components Actuators and Sensors: Characteristics of actuating systems, different types of actuators, sensor characteristics, different types of sensors
6. Robot Programming Methods (lead through, textual language), program as a path in space, speed control, motion interpolation, wait, signal and delay, branching, capability and limitations of lead through methods
References: <ol style="list-style-type: none">1. Koren Yoram, Robotics for Engineers, 2, McGraw-Hill Publication. , 20132. Groover M.P, Industrial Robotics, 3, Tata McGraw-Hill Publication, 20133. Niku Saeed B, Introduction to Robotics, 4, Prantice Hall India Publication, 2014



Course Code: 20EAME703	Course Title: Supply Chain Management	
L-T-P : 3-0-0	Credits: 3	Contact Hrs: 3
ISA Marks: 50	ESA Marks: 50	Total Marks: 100
Teaching Hrs: 40		Exam Duration: 3 hrs

Content
<p>1. Supply Chain Concepts</p> <p>Introduction to Supply Chain, SCOR model, Virtual/Extended Enterprise, Delivery Channel, Objective of a Supply Chain, Decision Phases in a Supply Chain, Production Approaches, Supply Chain Process, Push & Pull Production Systems, Push-Pull Boundary, Lack of Coordination and Bullwhip Effect, Order Management, Order-to-Cash Process, Procure-to-Pay Process, Call-off, Replenishment, Sourcing</p>
<p>2. Supply Chain Performance</p> <p>Supply Chain Strategies, Value Chain, Capabilities, Uncertainties, Responsiveness vs Cost, Supply Chain Performance Drivers – Facilities, Inventory, Transportation, Information, Sourcing, and Pricing, Supply Chain Visibility, Resilience, Non-Financial Metrics Examples, Financial Metrics Examples, Sustainability</p>
<p>3. Designing Distribution Network</p> <p>Introduction, Factors Influencing Distribution Network Design, Design Options for a Distribution Network, Distribution Network for Online Sales, Impact of Online Sales on Cost</p>
<p>4. Network Design</p> <p>Introduction, Factors Influencing Network Design Decisions, Framework for Network Design Decisions, Facility Location Mathematical Models, Capacity Allocation Mathematical Models, Network Behavior, Types of Supply Relationship, Factors influencing Nature of Network Relationship, Vertical Integration</p>
<p>5. Demand Management and Forecast</p> <p>House of SCM, Managing Demand, Managing Supply, Transportation Model, Just-in-Time in Supply Chain, Forecasting in Supply Chain, Characteristics of Forecasts, Approaches to Demand Forecasting</p>
<p>6. Inventory Management</p> <p>Cycle Inventory, Cycle Inventory Related Costs, Economics of Scales, Economic Order Quantity, Multiechelon Cycle Inventory, Uncertainty and Safety Inventory, Safety Inventory Level</p>
<p>7. Logistic and Warehouse Management</p> <p>Transportation in Supply Chain, Modes of Transportation, Transportation Network, Trade-offs in Transportation Design, Warehouse Layout and Design, Warehouse Types, Warehouse Operating Processes, Warehouse Management System, Procurement, Material Classification, Material Codification</p>



8. Trends in SCM

Gartner's Hype Cycle, Capgemini's Consulting Hype Cycle, Trend Categories, Algorithmic Supply Chain Planning, Predictive Analytics, Global Logistics Visibility, Focus on Risk Management and Supply Chain Resiliency

References:

1. Sunil Chopra, and Peter Meindl, Supply Chain Management – Strategy, Planning, and Operation, Pearson Education.
2. APICS, Operations Management Body of Knowledge Framework.
3. Lora Cecere, Supply Chain Metrics that Matter, Wiley.
4. Hartmut Stadtler, Supply chain management and advanced planning – basics, overview and challenges, European Journal of Operations Research, 163, 2015.
5. Keely L. Croxton, Sebastián J. García-Dastugue and Douglas M. Lambert, The Supply Chain Management Processes, The International Journal of Logistic Management.
6. Nickel Slack and Michael Lewis, Operations Strategy, Prentice Hall.



Course Code: 20EAME704	Course Title: Manufacturing Systems Simulation	
L-T-P : 3-0-0	Credits: 3	Contact Hrs: 3
ISA Marks: 50	ESA Marks: 50	Total Marks: 100
Teaching Hrs: 40		Exam Duration: 3 hrs

Content
<p>1. Simulation Modeling and Analysis Simulation Modeling and Analysis, Other types of simulation models, purpose of simulation, Advantages and Disadvantages of simulation, Limitations of simulation, Other considerations.</p>
<p>2. Principles of Modeling & Simulation Basic simulation modeling systems – discrete and continuous systems, general systems theory, models of systems- variety of modeling approach, Simulation as a decision making tool, Principle of computer modeling- Monte Carlo simulation, Nature of computer modeling.</p>
<p>3. Problem Formulation and Project Planning Formal problem statement, Orientation, Project objectives, Decision making tools for determining project objectives. Simulation in project management, Simulation project managers function, Developing the simulation project plan, Compressing projects, Advanced project management concepts.</p>
<p>4. System Definition, Input Data Collection and Analysis Systems classification, High level flow chart basics, Components and events to model, Data to be included in the model, Output data. Sources of input data, Collecting input data, Deterministic versus Probabilistic data, Discrete vs. Continuous data, Common input data distributions, Analyzing input data.</p>
<p>5. Model Translation, Verification and Analysis Simulation program selection, Model translation section, Program organization, Divide-and-Conquer approach, Advancing the simulation clock event by event, Need for validation, Two types of validation, Validation data analysis process.</p>
<p>6. Simulation Application Areas Manufacturing and material handling system, Automobile industry, Logistics and transportation systems, Health care, Service systems, Military.</p>
<p>References:</p> <ol style="list-style-type: none"> 1. Jerry Banks and John S Carson, Barry L Nelson, David M Nicol, Discrete event system simulation, Prentice Hall, India. 2. Ronald G Askin and Charles R Standridge, Modeling and analysis of manufacturing systems, John Wiley & Sons. 3. Gordon G, System Simulation, Prentice Hall, India.. 4. Shannon, R.E., System Simulation – The art and science, Prentice Hall, India. 5. Averill Law & David M. Kelton, Simulation, Modeling and Analysis, TMH.



II Semester M.Tech.

Course Code: 20EAMC705	Course Title: PLM Advanced	
L-T-P : 2-0-0	Credits: 2	Contact Hrs:2
ISA Marks: 50	ESA Marks: 50	Total Marks: 100
Teaching Hrs: 30		Exam Duration: 3 hrs

Content	Hrs
1. PLM Systems System Architecture, Information Models and Product Structures, Reasons for Deployment of PLM Systems, Use of PLM Systems in Different Organizational Verticals, Integration of the PLM System with other Applications.	06
2. Deployment of the PLM System Different stages of deployment, Leading a PLM Project, Understanding the need for change, PLM maturity model, Choosing a system, Realization stage of the project, Start up, Steering group, Project manager, Accomplishing change in the organization.	06
3. Business benefits of a PLM System Factors leading to PLM, Benefits of PLM in product lifecycle management, Measuring the business benefits in daily operations, PLM and data warehousing as a tool to support decision-making, Analyzing the cost of acquisition and the deployment of a PLM system, PLM software licenses, Database licenses, Hardware acquisition, Maintenance.	06
4. Challenges of Product Management in Manufacturing and Service Industries Life cycle thinking, Value added services and after sales traceability, Special challenges of product management in the high-tech industry, Case studies. Categorizing services, PLM in service business, PLM challenges in service business, Case studies.	08
5. Understanding the product Lifecycle The basic behavior of products and lifecycles, Using metrics to steer your business performance in various phases of the product lifecycle, Other aspects of product lifecycle, Building a product business case, Case studies.	04
Reference Books: <ol style="list-style-type: none"> 1. Antti Saakasvuori, Anselmi Immonen, Product Lifecycle Management - Springer, 1st Edition, 2003. 2. Grieves Michael, Product Lifecycle Management - Driving the Next generation of Lean Thinking, McGraw-Hill, 2006. 	



Course Code: 20EAMC706	Course Title: Enterprise Resource Planning-II	
L-T-P : 3-0-0	Credits: 3	Contact Hrs: 3
ISA Marks: 50	ESA Marks: 50	Total Marks: 100
Teaching Hrs: 40		Exam Duration: 3 hrs

Content	Hrs
<p>1. ERP implementation Basics</p> <p>Master Data Management – Item Master, Vendor Master, COA, Customer Master, Machine Master, etc. Vendors- Role of Vendor; Consultants: Types of consultants; Role of a Consultant, Employees; Role of employees; Resistance by employees; Dealing with employee resistance, Role of Top Management, Role of Implementation Partner</p>	04
<p>2. ERP implementation Life cycle</p> <p>Objectives of ERP implementation, Different phases of ERP implementation. Consultants, vendor and employees; <i>ERP Projects</i>: Project types, Implementation methodology, Project Preparation, Business Blueprinting, Gap Analysis, Realization, Final Preparation, Go Live and Support, User Training; <i>ERP Post Implementation</i>: Maintenance of ERP- Organizational and Industrial impact; Success and Failure factors and ERP Implementation; Difference between Implementation, Upgrade & Re-implementation; Configuration vs Customization in ERP project</p>	10
<p>3. ERP and e-Business</p> <p>Introduction ERP and e-business process model, components of e-Business supply chain ERP/ e-business integration ERP to ERP II –Bringing ERP to the Entire Enterprise</p>	06
<p>4. Future Directions in ERP</p> <p>Faster Implementation Methodologies; Business Modules and BAPIs; Convergence on Windows NT; Application Platform; New Business Segments; More Features; Web Enabling; Market Snapshot.</p>	06
<p>5. Other Related Technologies of SCM</p> <p>Relation to ERP; E-Procurement; E-Logistics; Internet Auctions; E-markets; Electronic Business Process Optimization; Business Objects in SCM; E commerce</p>	06
<p>6. Case Studies</p> <p>ERP case studies in HRM, Finance, Production, Product Database, Materials, Sales & Distribution</p>	08
<p>Reference Books:</p> <ol style="list-style-type: none"> 1. Ellen Monk & Bret Wagner, Concepts in Enterprise Resource Planning, 4th edition, Course Technology CENGAGE Learning. 2. Alexis Leon, Enterprise Resource Planning, 3rd Edition, Mcgraw Higher Ed. 3. Vinod Kumar Garg, N.K. Venkitakrishnan, Enterprise Resource Planning: 	



Concepts and Practice, 2nd Edition, Prentice Hall India Learning Private Limited.

4. Sadagopan S., Enterprise Resource Planning: A Managerial Perspective, Tata McGraw Hill, New Delhi.
5. Pauline Weetman, Financial and Management Accounting: An Introduction, Pearson Education Limited.



Course Code: 21EAMC701	Course Title: Project Feasibility and Analysis	
L-T-P : 3-0-0	Credits: 3	Contact Hrs: 3
ISA Marks: 50	ESA Marks: 50	Total Marks: 100
Teaching Hrs: 40		Exam Duration: 3 hrs

Content	Hrs
<p>1. Planning overview Capital investments, Types of capital investments, Phases of capital budgeting, Levels of decision-making, Facets of project analysis, Key issues in major investment decisions, Objectives of capital budgeting, Common weaknesses in capital budgeting.</p>	07
<p>2. Generation and Screening of Project Ideas Concept of strategy, Portfolio strategy, Business level strategies, Strategic planning and capital budgeting, Generation of ideas, Corporate appraisal, Tools for Identifying Investment opportunities. Scouting project ideas, Preliminary screening.</p>	07
<p>3. Market and Demand Analysis Situational analysis, Specification of objective, Portfolio management techniques, Conduct of market survey, Characteristics of market, SWOT analysis, Demand forecasting, Uncertainties in demand forecast, Marketing plan.</p>	06
<p>4. Technical Analysis Manufacturing process/technology, Material inputs and utilities, Product mix and Plant capacity, Location and site, Machineries and equipment, Structures and civil works, Environmental aspects, Project charts and layouts.</p>	07
<p>5. Financial Estimates and Projections Means of finance, Estimates of sales and production, Cost of production, Working capital requirement and its financing, Profitability projections, Projected cash flow statements, projected balance sheet.</p>	07
<p>6. The Impact of Sustainability on Project Management The concept of sustainability, Sustainability in project management, Inter-relating life cycles, The impact of sustainability on project management processes, Measuring and reporting projects, The impact of sustainability on project management competencies.</p>	06
<p>Reference Books:</p> <ol style="list-style-type: none"> 1. Prasanna Chandra, "Projects: Planning, Analysis, Financing, Implementation and Review", Tata McGraw-Hill Publishing Company Limited, New Delhi. 2. Nicholas J. M. and Steyn H. "Project Management for Business, Engineering and Technology: Principles and Practice", Elsevier. 3. Harold R. Kerzner, "Project Management: A Systems Approach to Planning, Scheduling, and Controlling", Wiley, New York. 	



Course Code: 20EAMC708	Course Title: Research Methodology	
L-T-P : 2-1-0	Credits: 3	Contact Hrs: 5
ISA Marks: 100	ESA Marks: --	Total Marks: 100
Teaching Hrs: 26	Tutorial Hrs: 24	Exam Duration: --

Content
Research: Definition, Characteristics and Objectives; Types of Research, Research Methodology, Research Process, Literature Review, Review concepts and theories, Formulation of Hypothesis, Research design, Data collection, Processing and analysis of data collected, Interpretation of data, Computer and internet: Its role in research, Threats and Challenges to research, Writing a research paper, research project, Thesis, Research ethics, Citation methods and rules. Case studies.
Reference Books: <ol style="list-style-type: none">1. Kothari C. R. "Research Methodology – Methods & Techniques", Wishwa Prakashan,2. Ranjit Kumar, "Research Methodology – A step by step guide for Beginners", 3rd Edition, Pearson Edition, Singapore, 2011.3. Dawson Catherine, "Practical Research Methods", UBS Publishers, New Delhi, 2002.



Course Code: 20EAME705	Course Title: Additive Manufacturing	
L-T-P : 3-0-0	Credits: 3	Contact Hrs: 3
ISA Marks: 50	ESA Marks: 50	Total Marks: 100
Teaching Hrs: 40		Exam Duration: 3 hrs

Content
<p>1. Additive Manufacturing (AM) Overview</p> <p>Introduction to reverse engineering Traditional manufacturing vs AM, Computer aided design (CAD) and manufacturing (CAM) vs AM, Different AM processes and relevant process physics, AM process chain Application level: Direct processes – Rapid-Prototyping, Rapid Tooling. Rapid Manufacturing; Indirect Processes - Indirect Prototyping. Indirect Tooling, Indirect Manufacturing</p>
<p>2. Materials Science of AM</p> <p>Discussion on different materials used, Use of multiple materials, multifunctional and graded materials in AM, Role of solidification rate, Evolution of non-equilibrium structure, Structure property relationship, Grain structure and microstructure</p>
<p>3. AM Technologies</p> <p>Powder-based AM processes involving sintering and melting (selective laser sintering, shaping, electron beam melting. involvement). Printing processes (droplet based 3D Solid-based AM processes - extrusion based fused deposition modeling object Stereo-lithography Micro- and nano-additive.</p>
<p>4. Mathematical Models for AM</p> <p>Transport phenomena models: temperature, fluid flow and composition, buoyancy driven tension driven free surface flow pool) Case studies: Numerical Modeling of AM process, Powder bed melting based process, Droplet based printing process Residual stress, part fabrication time, cost, optimal orientation and optimal Defect in AM and role of transport Simulations (choice of parameter, Model validation for different</p>
<p>5. Process selection, planning, control for AM</p> <p>Selection of AM technologies using decision methods. Additive manufacturing process plan: strategies and post processing. Monitoring and control of defects, transformation.</p>
<p>References:</p> <ol style="list-style-type: none"> 1. Ian Gibson, David W. Rosen, Brent Stucker, "Additive manufacturing technologies: rapid prototyping to direct digital manufacturing", Springer, 2010. 2. Andreas Gebhardt, "Understanding additive manufacturing: rapid prototyping, rapid tooling, rapid manufacturing", Hanser Publishers, 2011. 3. J.D. Majumdar and I. Manna, "Laser-assisted fabrication of materials", Springer Series in Material Science, e-ISBN: 978-3-642- 28359-8. 4. L. Lu, J. Fuh and Y.-S. Wong, "Laser-induced materials and processes for rapid prototyping", Kluwer Academic Press, 2001.



Course Code: 20EAME706	Course Title: Manufacturing Systems & Automation	
L-T-P : 3-0-0	Credits: 3	Contact Hrs: 3
ISA Marks: 50	ESA Marks: 50	Total Marks: 100
Teaching Hrs: 40		Exam Duration: 3 hrs

Content
1. Introduction Production system facilities, Manufacturing support systems, Automation in production system, Automation principles and strategies, Manufacturing operations, Basic elements of an automated system, Advanced automation functions, Levels of automation.
2. Material handling and identification technology Considerations in material handling system design, 10 principles of material handling, Automated guided vehicle systems, Conveyor systems, Analysis of material transport system, Automated storage systems, Engineering analysis of storage system. Components of manufacturing systems, Single station automated cells, Applications and analysis of single station cells.
3. Flexible manufacturing systems FMS components, FMS application and benefits, Quantitative analysis of flexible manufacturing systems.
4. Industrial control systems Sensors, Actuators, Drives and other control system components. Electro-hydraulic and Electro-pneumatics in manufacturing automations
5. Machine vision systems Importance of machine vision system in manufacturing automation.
6. Role of microcontrollers in manufacturing automation system Microcontroller architecture, interfacing sensors and actuators with microcontroller for industrial automation, Microcontroller programming.
7. PLCs in manufacturing automation Application of programmable logic controllers in manufacturing automation, PLC basic and advanced ladder logic programming using RsLogix and CoDeSys format, Usage of timers, counters, sequencing, and interlocking, latching, master control relay for developing programs for manufacturing automation. Temperature control, valve sequencing, conveyor belt control, control of a process etc
8. SCADA for Automation Elements of SCADA, Benefits of SCADA, Applications, Types of SCADA systems, Features and functions of SCADA, Building applications using SCADA for manufacturing automation.



References:

1. Grover M.P., "Automation, Production Systems and Computer Integrated Manufacturing", Pearson Education Asia.
2. Grover M.P., Weiss M. M., Nagel R.N. and Odrey N.G., "Industrial Robotics, Technology, Programming and Applications", Mc Graw Hill Book Publications.
3. Krishna Kant, "Computer Based Industrial Control" PHI.
4. W. Bolton , "Programmable Logic Controllers" Fifth Edition, Elsevier
5. Vijay R. Jadhav, "Programmable Logic Controller", Second Edition, Khanna Publishers.



Course Code: 20EAME707	Course Title: Manufacturing Execution Systems	
L-T-P : 3-0-0	Credits: 3	Contact Hrs: 3
ISA Marks: 50	ESA Marks: 50	Total Marks: 100
Teaching Hrs: 40		Exam Duration: 3 hrs

Content
<p>1. Enterprise and Enterprise Integration</p> <p>Enterprise and its characteristics, Strategic Planning, Feedback Loops, Time Definitions, Business Processes, Manufacturing Processes, Enterprise Integration, Horizontal Integration and Interoperability, Vertical Integration and Temporal Gap, Digitalization, Standards (ISO 15704)</p>
<p>2. Manufacturing Execution Systems and its Functionalities</p> <p>Manufacturing Execution Systems (MES), MES Functionalities, MES Models, Manufacturing Operations Management (MOM), Functional Control Model, MES in Discrete Industry, MES in Process Industry, Standards (IEC 62264, IEC 61512, VDI 5600)</p>
<p>3. Process and Data Modeling</p> <p>Enterprise Modeling, Process Modeling, Business Process Modeling Language (BPMN), Sankey Diagram, Entity-Relationship Diagrams, ARIS (ARchitecture for integrated Information Systems), Integrated Definition for Function Modelling (IDEF), Event-Driven Process Chain (EPC), Data Modeling, Data Flow Diagrams (DFDs), Unified Modeling Language (UML), Business to Manufacturing Markup Language (B2MML)</p>
<p>4. Data Collection</p> <p>Process Analysis, Process Modeling, Data Modeling, Data Flow Diagrams (DFDs), Communication Patterns, Technologies, OPC (OLE for Process Control)</p>
<p>5. Traceability And Tracking</p> <p>Tracing, Traceability, Enterprise Entities, Forward and Backward Traceability, Traceability Granularity, Tracking, Tracking Approaches, Regulations (GMP, US FDA, EudraLex)</p>
<p>6. PERFORMANCE MEASUREMENT</p> <p>Performance Measurement, Performance Management, Performance Measurement System and Characteristics, Key Performance Indicators (KPIs), Overall Equipment Effectiveness (OEE), Metrics Maturity Model, KPI Effectiveness, Process Improvement, Standards (ISO 22400, VDMA 66412)</p>
<p>7. Managerial Accounting</p> <p>Managerial Accounting, Cost Assignment Techniques, Cost Hierarchal Levels, Activity Drivers, Standard Cost, Actual Cost, Job Costing, Process Costing, Activity-Based Costing (ABC), Time-Driven ABC (TDABC), Resource Consumption Accounting (RCA), Cost of Poor Quality (COPQ)</p>



8. Real-Time Enterprise

Real-Time Enterprise (RTE), Event-Driven Architecture (EDA), Events, Complex Event Processing (CEP)

9. Industry 4.0

Industry 4.0, Challenges, Industrial Internet of Things (IIoT), Reference Architecture for Industry 4.0, Cyber-Physical Systems (CPS), Cyber-Physical Production Systems (CPPS), Smart Product, Smart Manufacturing, Smart Logistics, Smart Services

10. Business Analytics and Business Intelligence, Blockchain

Knowledge Management, Case-Based Reasoning (CBR), Big Data, Decision Analytics, Descriptive Analytics, Predictive Analytics, Prescriptive Analytics, Bitcoin and Blockchain, Merkle Tree, Blockchain Types, Scope and Application of Blockchain in Manufacturing

References:

1. Sachin Karadgi, "A Reference Architecture for Real-Time Performance Measurement," Springer, 2014.
2. Opher Etzion, Peter Niblett, "Event Processing in Action," Manning, 2011.
3. Roger Wattenhofer, "The Science of the Blockchain," CreateSpace Independent Publishing Platform, 2016.
4. Bruce Silver, "BPMN Method and Style - With BPMN Implementer's Guide," Cody-Cassidy Press, 2011.
5. Charles T. Horngren, George Foster, Srikant M. Datar, Madhav V. Rajan, Chris Ittner, "Cost Accounting: A Managerial Emphasis," Prentice Hall, 13th Edition, 2008.
6. Wood C. Douglas (Editor), "Principles of Quality Costs: Financial Measures for Strategic Implementation of Quality Management," ASQ, 4th Edition, 2013.
7. Gary Cokins, "Activity-Based Cost Management: An Executive's Guide," Wiley, 2001.
8. Robert S. Kaplan, Robin Cooper, "Cost & Effect: Using Integrated Cost Systems to Drive Profitability and Performance," Harvard Business Review Press, 3rd edition, 1997.
9. ISO 15704: Industrial Automation Systems—Requirements for Enterprise-Reference Architectures and Methodologies, 2000.
10. IEC 62264: Enterprise-Control System Integration. Multi—part standard.
11. IEC 61512: Batch Control. Multi—part standard.
12. ISO 22400—2: Automation Systems and Integration—Key Performance Indicators for Manufacturing Operations Management, Multi—part standard.
13. VDI 5600 Part 1: Manufacturing execution systems (MES), 2007.
14. OPC Foundation: OPC unified architecture specification part 1: overview and concepts, <http://www.opcfoundation.org/>.
15. MESA, MES Explained: A high level vision, white paper number 6, 1997.GMP
16. WHO Good Practices for Pharmaceutical Quality Control Laboratories, WHO Technical Report Series, No. 957, 2010.
17. Mike Bourne, Pippa Bourne, Handbook of Corporate Performance Management, Wiley, 2011.



Course Code: 20EAME708	Course Title: Robust Design Optimization	
L-T-P : 3-0-0	Credits: 3	Contact Hrs: 3
ISA Marks: 50	ESA Marks: 50	Total Marks: 100
Teaching Hrs: 40		Exam Duration: 3 hrs

Content
<p>1. Robust Design Overview</p> <p>Taguchi's approach to quality and quality loss function, noise factors and average quality loss, exploiting non linearity, classification of parameters</p>
<p>2. Analysis of variance</p> <p>No-Way ANOVA, One-Way ANOVA, Two-Way ANOVA and Three-Way ANOVA</p>
<p>3. Two Level Experiments</p> <p>Two factor factorial design, model adequacy checking and estimating model parameters, 2^2 full factorial design, 2^3 full factorial design, 2^k full factorial design and Two level fractional factorial design, General 2^{k-p} fractional factorial design.</p>
<p>4. Steps in Robust Design</p> <p>Identification of process and its main function, Noise factors and testing conditions, Control factors and their levels, Matrix experiment and data analysis plan, Conducting the experiment and data analysis, Verifying experiment and future plan.</p>
<p>5. Signal to Noise Ratios</p> <p>Comparison of the quality of two process conditions, Relationship between Signal to Noise Ratio and quality loss after adjustment, Identification of a scaling factor, Signal to Noise Ratios for static problems, Signal to Noise Ratios for dynamic problems, Analysis of ordered categorical data.</p>
<p>6. Taguchi Inner and Outer arrays</p> <p>Orthogonal arrays and fractional factorial designs, Parameter design and tolerance design, Analysis of inner/outer array experiment, Alternative inner/outer orthogonal array experiments.</p>
<p>7. Constructing orthogonal arrays</p> <p>Dummy level technique, Compound factor method, Linear graphs and Interaction assignment, Modification of linear graphs, Column merging method, Branching design.</p>
<p>References:</p> <ol style="list-style-type: none"> 1. Montgomery, D. C., "Design and Analysis of Experiments", John Wiley & Sons. 2. Khuri A. I. and Cornell J. A. "Response Surfaces: Designs and Analyses, Marcel Dekker, Inc., New York. 3. Myers R. H., Montgomery, D. C. and Anderson-Cook C. M. "Response Surface Methodology: Process and Product Optimization Using Designed Experiments", John Wiley & sons, Inc., New York.



4. Mason R. L., Gunst, R. F., Hess J. L., "Statistical design and Analysis of Experiments With Applications to Engineering and SISAnce", John Wiley & sons, Inc., New York.
5. Phadke M. S., "Quality Engineering using Robust Design", Prentice Hall PTR Englewood Cliffs, New Jersey.
6. Ross P. J., "Taguchi Techniques for Quality Engineering", McGraw -Hill International.



Course Code: 21EAMP701	Course Title: PLM Advanced Lab	
L-T-P : 0-0-3	Credits: 3	Contact Hrs: 6
ISA Marks: 80	ESA Marks: 20	Total Marks: 100
Teaching Hrs: 72		Exam Duration: 2 hrs

Content	Hrs
<p>1. Project Management Advanced</p> <p>Document the various risk areas of a project and track them, Create and manage the resource requirements for a project, Create budgets and benefits to monitor the financials of a project, Track the time spent on a project using time sheets, Create calendars for the projects, Identify the quality factors of a project and monitor them, Create an assessment to measure the project's health, Use dashboards to monitor the status of your projects, Manage the project schedule, Record risks for tasks, Create and submit timesheets.</p>	15
<p>2. Variant Management Essentials</p> <p>Create the product structure, Define product portfolios based on product roadmaps, Create and manage product configurations and design variants.</p>	15
<p>3. Traceable Requirements Management Essentials</p> <p>Create requirements and requirement specifications, Allocate requirements to products and models, Create test cases and use cases, Create revision and multiple versions of requirements, Generate traceability reports.</p>	15
<p>4. Platform Management and Baseline Behavior</p> <p>Create collaborative spaces and users, Assign required access rights to different users, Explore the Control widget and its related features, Configure PLM platform to add additional features as per requirements.</p>	15
<p>5. Open Ended Experiments</p> <p>Project management advanced, Variant management essentials, Traceability requirements management essentials, Platform management and baseline behavior.</p>	12
<p>References:</p> <ol style="list-style-type: none"> 1. Companion Courses – https://companion.3ds.com/ 2. Antti Saakasvuori, Anselmi Immonen, "Product Lifecycle Management" - Springer, 1st Edition, 2003. 	



Course Code: 20EAMP705	Course Title: ERP Technical Lab	
L-T-P : 0-0-2	Credits: 2	Contact Hrs: 4
ISA Marks: 80	ESA Marks: 20	Total Marks: 100
Teaching Hrs: 48		Exam Duration: 2 hrs

Content	Hrs
1. Financial Accounting (Advanced) Fixed assets, Budget, Cost center accounting	16
2. MRP Sales forecast, MRP run, Order recommendation	15
3. Admin and Technical Application installation (APP and DB), System initialization, Set-up, Technical Enhancement – UI, Report – Query generation, Crystal report, Print layout design, Basics of Integration	15
4. Reports Generation of reports for various functional modules	02
References: 1. SAP Business One Manual.	



Course Code: 20EAMP706	Course Title: Product Automation Lab	
L-T-P : 0-0-3	Credits: 3	Contact Hrs: 6
ISA Marks: 80	ESA Marks: 20	Total Marks: 100
Teaching Hrs: 96		Exam Duration: 2 hrs

Content
1. Knowledge Based Engineering: <ul style="list-style-type: none">- Customize the tree to display knowledge ware features- Create parametric models- Embed design knowledge in the models- Automate the design and modification processes- Create design configurations using design tables
2. JAVA: <ul style="list-style-type: none">-OPPS Concept:-String Handling-Exception Handling-Collection Framework.-Database Concepts.
3. JSP: <p>JSP-Lifecycle, JSP Syntax, JSP Directives, JSP Actions, JSP –Client request, JSP Server Response.</p>
4. HTML: <p>Tags, Attributes and Elements, Links, Images, Tables, Forms</p> <p>CSS: CSS basics, styles, CSS syntax</p>
5. JavaScript: <p>JavaScript Output, JavaScript Statements, JavaScript Syntax, JavaScript Variables, JavaScript Operators, JavaScript Arithmetic, JavaScript Strings, JavaScript Events, JavaScript Loop, JavaScript Objects, JavaScript functions.</p>
6. Python: <p>Python programming skills using data structures and constructs, python programming skills using functions and packages.</p>
References: <p>Companion Courses – https://companion.3ds.com/</p>

 KLE Technological University <small>Creating Value Leveraging Knowledge</small>	Document #: FMCD2005	Rev: 1.0
	Title: Curriculum Content- Course wise	Page 1 of 28 Year:2021-22

**School of Architecture,
 KLE Technological University,
 BVBCET Campus, Vidyanagar, Hubli.**

CURRICULUM SCHEME & SYLLABUS OF

III Semester - IV Semester

(Year of introduction-2015, Faculty-A, Architecture-AT, Core course-C, Humanities-H, Lab-L, Elective-E, internship-I, Practice-p, W-Project)

 KLE Technological University <small>Creating Value Leveraging Knowledge</small>	Document #: FMCD2005	Rev: 1.0
	Title: Curriculum Content- Course wise	
		Page 2 of 28
		Year:2021-22

Semester: III (2020-21)

Sr.No	Course code	Course Title	Period			Evaluation scheme			Credit (L+T+P)	Hours
			L	T	P	ISA	ESA	Sub total		
1	18AATC201	Architectural Design III	0	6	0	50	50	100	6	9
2	18AATC202	Building Const & Materials III	0	4	0	50	50	100	4	6
3	18AATC203	Services – I (w s & sanitation)	2	0	0	50	50	100	2	2
4	18AATC204	Climatology	2	0	0	50	50	100	2	2
5	18AATC205	History of Architecture II	2	0	0	50	50	100	2	2
6	18AATC206	Measure Drawing	0	2	0	50	50	100	2	4
7	18AATC207	Structures – III	3	0	0	50	50	100	3	3
8	18AATP201	Digital Tool-II	0	0	1	50	50	100	1	2
TOTAL			9	12	1	400	400	800	22	30

ISA: In-semester Assessment **ESA:** End Semester Assessment **L:** Lecture **T:** Tutorials **P:** Practical

Credit	Lecture Hours	Studio Hours	Practical Hours
1	1	1.5	2

Program Head

Signature of Dean (Academic Affairs)

 KLE Technological University <small>Creating Value Leveraging Knowledge</small>	Document #: FMCD2005	Rev: 1.0
	Title: Curriculum Content- Course wise	
		Page 3 of 28
		Year:2021-22

Semester: IV (2020-21)

Sr.No	Course code	Course Title	Period			Evaluation scheme			Credit (L+T+P)	Hours
			L	T	P	ISA	ESA	Sub total		
1	18AATC208	Architectural Design IV	0	6	0	50	50	100	6	9
2	18AATC209	Building Const & Materials IV	0	4	0	50	50	100	4	6
3	18AATC210	Services II (Electricity & Illumination)	2	0	0	50	50	100	2	2
4	18AATC211	History of Architecture III	2	0	0	50	50	100	2	2
5	18AATC212	Theory of Architecture	2	0	0	50	50	100	2	2
6	18AATC213	Quantity survey & specification	2	0	0	50	50	100	2	4
7	18AATC214	Structures – IV	3	0	0	50	50	100	3	3
8	18AATE201 TO 206	Elective-I	0	1	0	50	50	100	1	2
TOTAL			11	11	0	400	400	800	22	30

ISA: In-semester Assessment **ESA:** End Semester Assessment **L:** Lecture **T:** Tutorials **P:** Practical

Credit	Lecture Hours	Studio Hours	Practical Hours
1	1	1.5	2

	 KLE Technological University <small>Creating Value Leveraging Knowledge</small>	Document #: FMCD2005	Rev: 1.0
Title: Curriculum Content- Course wise		Page 4 of 28 Year:2021-22	

Program Head

Signature of Dean (Academic Affairs)



III- SEMESTER



Title: Curriculum Content- Course wise

Page 6 of 28

Year:2021-22

Program : Architecture

Course Title: ARCHITECTURAL DESIGN – III

Course Code: 18AATC201

L-S-P: 0-6-0

Credits: 6

Contact Hours: 9

ISA Marks: 50

ESA Marks: 50

Total Marks: 100

Teaching Hours: 126

Examination Duration: NA

Course contents:

To develop skills for comprehensive understanding and dealing with Socio Cultural aspects of Architecture. To develop the ability to create spaces and corresponding form. Provide skills for designing multi-user and multi level spaces.

The design issues to be addressed are Socio Cultural Aspects of smaller scale community .

- Contextual Based Design
- Multi user and multi level space formation
- Integration of material and form.
- Develop skills to correlate the materials and the resulting form.

The list of suggested spaces to be covered as design projects: Architectural Exhibition / display spaces, museums, cultural centers, higher level academic spaces, multi activity Recreational spaces, NeighborhoodCommunity spaces, Healthcare Centers etc.

Necessary theoretical inputs to be given highlighting the norms and design issues. At least one major exercise and one minor design/ time problem should be given.

Scheme for Internal semester assessment (ISA)

Regular assignments , Models , Reviews.

Term work: Evaluation of Portfolio and assignments by internal examiner.

Scheme for End Semester Assessment (ESA)

Term work: Evaluation of Portfolio and assignments by internal and external examiners/Viva

Mode of assessment: Portfolio, Physical models ,manual hand drafted drawings.

Text Books: NIL

Reference Books:

1. Time Saver Standard for Architectural Data by John Hancock.
2. Architectural Graphic Standards by Ramsey and Sleeper.
3. Magazines and Design related books
4. Architecture: Form, Space and Order, Ching, Francis DK
5. Design and Form: The basic course at the Bauhaus, Itten, Johannes.
6. Elements of space forming, Yatin Pandya.
7. Architectural Composition, Krier, Rob



Title: Curriculum Content- Course wise

Page 7 of 28

Year:2021-22

Program : Architecture

Course Title: BUILDING CONSTRUCTION&MATERIALS- III

Course Code: 18AATC202

L-S-P: 0-4-0

Credits: 4

Contact Hours: 6

ISA Marks: 50

ESA Marks: 50

Total Marks: 100

Teaching Hours: 84

Examination Duration: 3 hrs

Course contents

UNIT I:

RCC foundation, columns and beams

shallow foundation- Types, with reinforcement arrangements for i) isolated ii) combined iii) Combined with strap beam iv) eccentric v) raft, etc.

Deep foundation- Introduction to and study of pile, grouping of piles & pile cap.

Materials, formwork, stairs

Reinforcement - Types, properties & uses of plain, ribbed, twisted, TMT, weld mesh, HT wires etc.

Concrete- Ingredients, grades of concrete, properties of concrete, proportioning, mixing, transporting, placing, compaction & curing.

Special concrete - RMC, concreting under water, light and heavy weight, dense, etc

Form-work- Purpose of form work in concrete works. Various materials used, precautions to be taken and removal time

RCC COLUMNS - Various shapes of columns and types of reinforcement arrangements.

BEAMS – Reinforcement arrangement for i) simply supported ii) continuous iii) cantilever iv) brackets.

UNIT II:

Stairs - Introduction to, types & calculation of stairs. Study of stairs in 1) RCC. Construction details for timber, fabricated steel & RCC, including fixing of handrail in various materials

UNIT III:

Joints in RCC.

Study, necessity & construction details of construction joint and expansion joints

Scheme for Internal semester assessment (ISA)

Regular Assignments, models.

Term work: Evaluation of Portfolio, assignments by internal examiner

Scheme for End Semester Assessment (ESA)

External examination-3 hrs

Mode of assessment:

Portfolio&Theory Exam.



Title: Curriculum Content- Course wise

Page 8 of 28

Year:2021-22

Text Books: NIL

Reference Books:

1. McKay J.K Building Construction Metric Vol 1-4, 4th edi Orient Longman Pvt. Ltd, Mumbai,2002
2. "Construction Technology" volume-I by R Chudley, ELBS & Longman group Ltd.
3. Barry R, "The construction of buildings" , Vol-2, 5th Edi, East West Press, New Delhi 1999.
4. Bindra S.P and Arora S.P, Building Construction-Planning Techniques and Method of Construction, 19th edi, Dhanpat Rai Pub ,NewDelhi, 2000
5. "Building Construction" by Janardhan Jha, Khanna New-Delhi.
6. Rangawal S.C, "Building Construction" 22nd Edi, charotar Publishing house, Anand, 2004
7. "Engineering Materials" by Surendra Singh, Vikas Delhi.
8. "Building Materials" by S K Duggal, IBH New Delhi.
9. Sushil Kumar T.B of Building Construction 19th edi, Standard Pub House, NewDelhi, 2003.
10. Chowdhary K.P. Engineering Materials used in India, 7th Edi, Oxford and IBH Pub ltd New Delhi, 1990.
11. Building Construction Hand book : By R Chudly & R Greeno, Bullerworth Heinemann, New-Delhi.

Scheme for End Semester Assessment (ESA)

SI.No	8 Questions to be set of 20 Marks Each	Chapter Number	Instructions
I	Q.No.-1, Q.No.-2,	1, 2	Solve Any 1 out of 2
II	Q.No.-3, Q.NO – 4,	3, 4	Solve Any 1 out of 2
III	Q.No.-5, Q.No.-6	4,5	Solve Any 1 out of 2



Title: Curriculum Content- Course wise

Page 9 of 28

Year:2021-22

Program : Architecture

Course Title: SERVICES – I (WATER SUPPLY & SANITATION)

Course Code: 18AATC203

L-S-P: 2-0-0

Credits: 2

Contact Hours: 2

ISA Marks:50

ESA Marks: 50

Total Marks: 100

Teaching Hours: 28

Examination Duration: 3HOURS

Course contents

UNIT I:

1: Sources and purification of water

Surface and underground sources of water supply, pollution and preventive measures.

Purification ---filtration, disinfection, softening, miscellaneous methods of water treatment.

2: Domestic water supply

Water requirement for different types of buildings, pipes, valves, wash basins, sink, bath tubs, flushing cisterns, showers, jets, faucets. Cold and hot water supply for ground and multi-storied buildings. Provision for fire fighting, solar heating systems, geysers.

UNIT II:

3: Sanitation

Importance of sanitation, definitions, types of refuse, collection and disposal systems. Rural sanitation. Types of fixtures and materials. Sanitary requirements for various types of buildings.

4: Drainage systems

Principles, location of sanitary units, separate and combined systems, septic tanks, aqua privy. Drainage system for ground and multistoried buildings including. storm water drainage, rain water harvesting.

UNIT III:

5:Recycling

Sewage pumping stations, waste water treatment, oxidation. recycling of sewage water.

6: Site planning

Roads and pavements, drainage of roads, drainage on sloping sites, sub soil drainage. Site planning from drainage and water supply point of view.

Scheme for Internal semester assessment (ISA)

Regular Assignments.

Scheme for End Semester Assessment (ESA)

External examination-3 hrs

Mode of assessment:Portfolio& Theory Exam.

Text Books:NIL

Reference Books:

1.Husain, S. K. T. B. of water Supply and Sanitary Engineering, 3rd ed. Oxford and IBH Pub. Ltd. New Delhi, 1994.



Title: Curriculum Content- Course wise

Page 10 of 28

Year:2021-22

- 2.Kshirsagar,S.R. Water Supply Engineering, 6th ed. Roorkee Pub, Roorkee, 1980.
- 3.Rangawala, S.C. Water Supply and Sanitary Engineering ; Environmental Engineering, 19th ed. Charotar Pub. House, Anand, 2004.
- 4.S.C. Rangawala, fundamentals of water supply and sanitary engineering. Charotar Pub. House, Anand,
- 5.IIussain S. K. water supply and sanitary engineering, Dhanapat Rai and Sons, Delhi Relevant I.S. Codes
- 6.Basic Plumbing techniques, Orthobooks, Chevron Chemical Company, Consumer products Div., Box 5047, San Ramon, CA 94583
- 7.G.M. Fair, J.C. Geyer and D.A. Oku, Water and Waste Water Engineering, vol.II, John Wiley and Sons, Inc. New York, 1968
- 8.Manual of water Supply and Treatment , 2nd edition , CPHEEO, Ministry of works And HOUSING New DELHI , 1980
- 9.Manual ON sewage Treatment , CPHEEO, Ministry of works And HOUSING New DELHI , 1977

Scheme for End Semester Assessment (ESA)

Sl.No	8 Questions to be set of 20 Marks Each	Chapter Number	Instructions
I	Q.No.-1, Q.No.-2,	1, 2	Solve Any 1 out of 2
II	Q.No.-3, Q.NO – 4,	3, 4	Solve Any 1 out of 2
III	Q.No.-5, Q.No.-6	4,5	Solve Any 1 out of 2



Title: Curriculum Content- Course wise

Page 11 of 28

Year:2021-22

Program : Architecture

Course Title: CLIMATOLOGY

Course Code: 18AATC204

L-S-P: 2-0-0

Credits: 2

Contact Hours: 2

ISA Marks: 50

ESA Marks: 50

Total Marks: 100

Teaching Hours: 28

Examination Duration: 3hrs

UNIT I:

Introduction – Elements of Climate, Enumerating and representing climatic data. Classification of Climate, major Climatic Zones of the World, tropical Climate further Classification. Climatic Zones of India, Classifications, case study of one city within each Zone.

UNIT II:

Thermal Comfort, effect of Climatic Elements on thermal Comfort, Heat Exchange Process, Effective Temperature Natural Ventilation, effect of openings in internal and external features, Design Considerations etc. Effect of Landscape elements and site topography, reading climate data, climate analysis and data validation through climate consultant software.

UNIT III:

Bioclimatic chart, Design Consideration for various climatic zones of INDIA, with respect to Shading devices, Day Lighting Factors, Components of day light factor and its design considerations, Rainfall considerations etc. Construction Techniques for Improving Thermal Performance of Walls and roofs at various climatic Zones in India. Climate data representation through flow design and ecotect software. Design project of not more than 500sqm. built up incorporating all the components of climate responsive architecture.

Scheme for Internal semester assessment (ISA)

Regular Assignments, Architectural models, rendered sheets and photos

Scheme for End Semester Assessment (ESA)

External examination-3 hrs

Mode of assessment :

Portfolio & Theory Exam.

Reference Books : NIL

Text Books:

1. Arvind Kishan , Baker & Szokolay, Climate Responsive Architecture.
2. Manual of Tropical Housing & Buildings (PartII) Koenigsberger.
3. Buildings in the tropics by Maxwell Fry
4. Housing , Climate and Comfort by Martin Evans



Title: Curriculum Content- Course wise

Page 12 of 28

Year:2021-22

Scheme for End Semester Assessment (ESA)

Sl.No	8 Questions to be set of 20 Marks Each	Chapter Number	Instructions
I	Q.No.-1, Q.No.-2,	1, 2	Solve Any 1 out of 2
II	Q.No.-3, Q.NO – 4,	3, 4	Solve Any 1 out of 2
III	Q.No.-5, Q.No.-6	4,5	Solve Any 1 out of 2



Title: Curriculum Content- Course wise

Page 13 of 28

Year:2021-22

Program : Architecture

Course Title: HISTORY OF ARCHITECTURE - II

Course Code: 18AATC205

L-S-P: 2-0-0

Credits: 2

Contact Hours: 2

ISA Marks: 50

ESA Marks: 50

Total Marks: 100

Teaching Hours: 32

Examination Duration: 3 Hrs

Course contents

UNIT I:

1:Evolution of Buddhist Architecture

Characteristic features of Buddhist Architecture, Sanchi Stupa, Viharas and Chaitya Halls

2:Introduction to temple architecture

Essential characteristics of Indian temple,different types of temple architecture

Evolution of Hindu Temple

Temples at Udayagiri, Tigawa, Bhitargoah

3. Evolution of Indo Aryan Temples

Orissa Group of Temples - The Sun temple of Konark , The Lingraja Temple at Bhubaneswar ,

Khajuraho Group of Temples - Kandariya Mahadev Temple, Laksmanan Temple

UNIT II:

4 -Early Chalukyan Architecture –

Aihole , Pattadakal and Badami

5 : Rastrakuta Architecture

Rockcut Temple, Elephanta , Kailasa Temple Ellora

6: Evolution of Pallava , Cholla and Pandya style

Pallava Style - Rathas at Mamallapuram , Shore temple, Kailasanath temple

Kanchipuram , Vaikunthaperumal temple at Kanchipuram,

Chola Style – Brihadeshwar Temple & Gangaikondacholapuram Temple

Pallava Style – Characteristics, Gopuram

UNIT III:

7-Later Chalukyan or Hoyasala style

Chennakeshwa Temple, Belur, Hpyaleshwar Temple, Halebidu and Keshava Temple, Somnathpur

8- Evolution of later Dravidian Temples

Vijaynagar Architecture - Vithala temple complex at Vijaynagar , Hazara Ram Temple

Meenakshi Temple at Madurai. Srirangam Temple

Scheme for Internal semester assessment (ISA)

Regular Assignments, models.

Term work: Evaluation of Portfolio, assignments by internal examiner

Scheme for End Semester Assessment (ESA)

External examination-3 hrs



Title: Curriculum Content- Course wise

Page 14 of 28

Year:2021-22

Mode of assessment :

Portfolio& Theory Exam

Text Books:NIL

Reference Books:

1. Satish Grover: The Architecture of India
2. Percy Brown : Indian Architecture(Buddhist and Hindu Period)
3. Tadgell Christopher:The History of Architecture in India
4. Rowl Benjamin. Art and Architecture of India
5. Vistara . The Architecture of India
6. Yatin Pandya: Concept of space making in Indian traditional Architecture

Scheme for End Semester Assessment (ESA)

Sl.No	8 Questions to be set of 20 Marks Each	Chapter Number	Instructions
I	Q.No.-1, Q.No.-2, Q.No.-3	1, 2,3	Solve Any 2 out of 3
II	Q.No.-4, Q.No. – 5 Q.No.-6,	4, 5,6	Solve Any 2 out of 3
III	Q.No.-7, Q.No.-8	7,8	Solve Any 1 out of 2



Title: Curriculum Content- Course wise

Page 15 of 28

Year:2021-22

Program : Architecture

Course Title: MEASURE DRAWING

Course Code: 18AATC206

L-S-P: 0-2-0

Credits: 2

Contact Hours: 4

ISA: 50

ESA: 50

Total Marks: 100

Teaching Hours: 32

Examination Duration: NA

Course contents

The students can study vernacular, regional buildings and document, measured drawing to be prepared. The site visits/documentation could be carried out during vacation, weekends. The assignment may be given as group work.

UNIT I:

Detailed plans with all measurements to be compiled and submitted including site plan. The report comprising of historic evolution, climatic influence, construction techniques, materials applications to be prepared along with drawings.

UNIT II:

Detailed sectional drawings, elevation drawings along with details of individual elements to be submitted. Study the construction techniques

UNIT III:

Digital documentation in the form of photography, videography & analysis of the entire project.

Scheme for Internal semester assessment (ISA)

Regular Assignments, Architectural models, rendered sheets and photos

Scheme for End Semester Assessment (ESA)

Term work: Evaluation of Portfolio, assignments by internal and external examiners

Mode of assessment :

Portfolio

Text Books : NIL

Reference Books : NIL

 KLE Technological University Creating Value Leveraging Knowledge	Document #: FMCD2005	Rev: 1.0
	Title: Curriculum Content- Course wise	
		Page 16 of 28
		Year:2021-22

Program : Architecture		
Course Title: STRUCTURES - III		Course Code: 18AATC207
L-S-P: 3-0-0	Credits: 3	Contact Hours: 03
ISA Marks: 50	ESA Marks: 50	Total Marks: 100
Teaching Hours: 48	Examination Duration: 3 HOURS	
Course contents		
UNIT I:		
1.Reinforced cement concrete, grades of concrete, water cement ratio and its effect on strength of concrete, admixtures, retarders and use of high strength concrete in building structures. 2. Introduction to working stress method, assumptions, theory of singly reinforced sections.Moment of resistance and design of a section for flexure. Related elementary numerical.		
UNIT II:		
3. Design philosophy of limit state method. Limit state for collapse for flexure. 4. Analysis of continuous beam by using IS 456-2000 and design by using SP16. 5.Design of beams by using SP 16 6. Analysis of one way continuous slabs by using IS 456-2000and design by using SP16. 7.Design of columns axial load and axial load plus uniaxial moment by using SP 16		
UNIT III:		
8. Case study of ongoing RC building structures to correlate knowledge to on site during construction. 9. Typical reinforcement detail for beams isolated column with footing, slabs (one way and two way), staircases.		
Scheme for Internal semester assessment (ISA)		
Regular Assignments.		
Scheme for End Semester Assessment (ESA)		
External examination-3 hrs		
Mode of assessment : Portfolio& Theory Exam.		
Text Books:		
1. A.K. Jain, Reinforced concrete: Limit state design, 5 th edition, New Chand and brothers, Roorkee. 2. S.N. Sinha, Reinforced concrete design, Tata McGraw Hill Publications, New Delhi.		
Reference Books		
1. Karve S. R. and Shah V. L: .Limit state Theory and design of Reinforced Concrete, Structures Publishers, Pune 2. S.N. Sinha, Reinforced Concrete Tata Mc.Graw Hill Companies. Second Revised Edition. 3.Ashok Kumar Jain, Arun kumar Jain, Reinforced Concrete Structures Laxmi Publications Pvt. Ltd. New Delhi 4. Ashok K. Jain. Reinforced Concrete Limit State Nemchand & Bros.Roorkee		



Title: Curriculum Content- Course wise

Page 17 of 28

Year:2021-22

Scheme for End Semester Assessment (ESA)

Sl.No	8 Questions to be set of 20 Marks Each	Chapter Number	Instructions
I	Q.No.-1, Q.No.-2, Q.No.-3	1, 2,	Solve Any 2 out of 3
II	Q.No.-4, Q.NO – 5 Q.No.-6,	3,4, 5,6,7	Solve Any 2 out of 3
III	Q.No.-7, Q.No.-8	8,9	Solve Any 1 out of 2



Title: Curriculum Content- Course wise

Page 18 of 28

Year:2021-22

Program : Architecture

Course Title: DIGITAL TOOL - II

Course Code: 18AATP201

L-S-P: 0-0-1

Credits: 1

Contact Hours: 2

ISA Marks:50

ESA Marks: 50

Total Marks: 100

Teaching Hours: 32

Examination Duration: NA

Course contents

UNIT I:Introduction to SketchUp:

File formats, Page setups, User interface, Types of tools

Drawing and editing tools in SketchUp

Basic drawing and editing tools to develop the basic forms

UNIT II:

Dimensioning tools and navigation.

Measuring, Dimensioning , Lettering, Navigation tools, etc

Introduction to Advance Sketch up

Advance tools for developing and creating architectural design using advanced features, shadows, Sand box tools , etc

UNIT III:

Rendering techniques with Sketch Up.Setting up Lights, camera, foreground and background, adding landscaping elements like trees, human figures, introduction to rendering and animation. Importing and exporting to other software.

Explore Plug-in like V Ray, etc

Scheme for Internal semester assessment (ISA)

Regular Assignmentsby internal examiner.

Scheme for End Semester Assessment (ESA)

Evaluation of Assignments in form of soft copy & hard copy worked during the course by internal and external examiners.

Mode of assessment : Portfolio

Text Books : NIL

Reference Books:Online SketchUp Manual.



IV SEMESTER



Title: Curriculum Content- Course wise

Page 20 of 28

Year:2021-22

Program : Architecture

Course Title: Architectural Design – IV

Course Code: 18AATC208

L-S-P:0-6-0

Credits: 6

Contact Hours:9

ISA Marks: 50

ESA Marks: 50

Total Marks: 100

Teaching Hours: 126

Examination Duration: NA

Course contents:

To develop skills for comprehensive understanding and dealing with Climate Responsive Architecture. Provide skills for designing multi-user and multi level spaces.

The design issues to be addressed are

- Climate Responsive
- Integration of environment & built form.
- Integration the horizontal and vertical circulation
- Correlation of the materials and the resulting form.

The list of suggested spaces to be covered as design Public Libraries, Public and Semipublic Office Spaces, Resorts, Recreational Clubs, Automobile Showrooms etc.

Necessary theoretical inputs to be given highlighting the norms and design issues. At least one major exercise and one minor design/ time problem should be given. The topics covered as design projects will have to be covered by the studio faculty members through lecture/slide show session and site visits.

Scheme for Internal semester assessment (ISA)

The Portfolio covering the given topics and the study models shall be presented.

The evaluation shall be through periodic internal reviews.

The students have to present the entire semester work for assessment along with Models.

Regular Assignments, Architectural models, rendered sheets and photos

Scheme for Semester End Assessment (ESA)

Term work: Evaluation of Portfolio, assignments by internal and external examiners/ Viva

Mode of assessment :

Portfolio

Text Books: NIL

Reference Books:

1. Joseph De Chiara & John Hancock Calendar, Time Saver Standards for Building Types
2. Various books and magazines about architectural design
3. Architecture: Form, Space and Order, Ching, Francis DK



Title: Curriculum Content- Course wise

Page 21 of 28

Year:2021-22

Program : Architecture

Course Title: BUILDING CONSTRUCTION & MATERIALS - IV

Course Code: 18AATC209

L-S-P: 0-4-0

Credits: 4

Contact Hours: 6

ISA Marks: 50

ESA Marks: 50

Total Marks: 100

Teaching Hours: 84

Examination Duration: 3 Hrs

Course contents

UNIT I:

RCC SLABS

Introduction to, types & selection criteria of slabs like i) spanned in one direction ii) spanned in both directions i.e. iii) continuous iv) cantilever v) slope vi) ribbed vii) coffered viii) filler, showing construction & reinforcement arrangements

UNIT II:

RCC FLAT SLAB, VAULTS & DOMES AND RETAINING WALLS

Flat slab- Introduction to, advantages over regular slabs, including construction details & reinforcement arrangements for i) solid slab ii) drop panel iii) flared column top.

Vaults and domes - Introduction to, types, construction details with reinforcement arrangement.

Retaining walls – Introduction to and study of walls for retaining earth & water, with i) brick masonry ii) stone masonry iii) RCC. Construction details & reinforcement arrangements there in.

UNIT III:

FLOOR FINISHES

Various types, method of laying & maintenance for floor finishes using, Naturally available - i) clay & Murom ii) stone slab & tiles iii) timber: Timber products - i) parquet tiles ii) plywood/ block board & engineered wood (plain & laminated) etc. Cement concrete - i) rough and rendered (IPS, oxide, epoxy) surface ii) VDC (vacuum de-watered concrete) Cement concrete products - marble mosaic, terrazzo, designer tiles & in-situ work Mineral products – clay, ceramic & vitrified tiles. Other products – i) metal ii) glass . paving - Various types, preparation of base, method of laying using i) burnt bricks ii) flag stone iii) stone slabs iv) cobbles v) in-situ concrete vi) precast concrete slabs vii) concrete designer tiles viii) interlocking blocks etc

Note – The Portfolio covering the above topics shall be presented for Term work. Site visits shall be arranged by studio teacher. Study of material application shall be submitted in the form notes, sketches and photo brief as a part of portfolio

Scheme for Internal semester assessment (ISA)

Regular Assignments, models.

Term work: Evaluation of Portfolio, assignments by internal examiner

Title: Curriculum Content- Course wise

Page 22 of 28

Year:2021-22

Scheme for Semester End Assessment (ESA)

External examination-3 hrs

Mode of assessment:

Portfolio & Theory exam.

Text Books:

1. McKay J.K Building Construction Metric Vol 1-4, 4th edi Orient Longman Pvt. Ltd, Mumbai,2002
2. "Construction Technology" volume-I by R Chudley, ELBS & Longman group Ltd.
3. Barry R, "The construction of buildings" , Vol-2, 5th Edi, East West Press, New Delhi 1999.
4. Bindra S.P and Arora S.P, Building Construction-Planning Techniques and Method of Construction, 19th edi, Dhanpat Rai Pub ,NewDelhi, 2000
5. "Building Construction" by Janardhan Jha, Khanna New-Delhi.
6. Rangawal S.C , "Building Construction" 22nd Edi, charotar Publishing house, Anand, 2004
7. "Engineering Materials" by Surendra Singh, Vikas Delhi.
8. "Building Materials" by S K Duggal, IBH New Delhi.
9. Sushil Kumar T.B of Building Construction 19th edi, Standard Pub House, NewDelhi, 2003.
10. Chowdhary K.P. Engineering Materials used in India, 7th Edi, Oxford and IBH Pub ltd New Delhi, 1990.
11. Building Construction Hand book : By R Chudly & R Greeno, Bullerworth Heinemann, New-Delhi.

Scheme for End Semester Assessment (ESA)

Sl.No	8 Questions to be set of 20 Marks Each	Chapter Number	Instructions
I	Q.No.-1, Q.No.-2, Q.No.-3	1, 2,3	Solve Any 2 out of 3
II	Q.No.-4, Q.NO – 5 Q.No.-6,	4,5, 6	Solve Any 2 out of 3
III	Q.No.-7, Q.No.-8	7,8	Solve Any 1 out of 2



Title: Curriculum Content- Course wise

Page 23 of 28

Year:2021-22

Program : Architecture

Course Title: SERVICES – II (ELECTRICITY & ILLUMINATION)

Course Code: 18AATC210

L-S-P:2-0-0

Credits: 2

Contact Hours: 3

ISA Marks:50

ESA Marks: 50

Total Marks: 100

Teaching Hours: 48

Examination Duration: 3 hrs

Course contents

UNIT I:

1. Brief Introduction to electricity, its uses in everyday life and as an architectural application. Terminology used in electricity.
2. Supply and distribution of electricity to the end user (consumer) - generators and overhead and underground distribution systems, high tension and low tension cables, substations, transformers, service connections, panel board, energy meter. Internal supply and distribution.
3. Systems of wiring in building and their merits. Types of conduits, wires and cables. Accessories used in wiring. Branch circuits, calculation of electrical load for a residential building.

UNIT II:

4. Various devices used to protect shock, over loading, leakages and short circuits.(Fuses-definition and types, ELCB, Earthing-definition and its types, MCB'S) . Electrical symbols and Indian electricity rules-relevant codes of practice (NBC).
5. Electrical layout for different buildings.
6. Alternative sources of electricity and its implementation in building. Ways and methods of saving electricity in buildings.

UNIT III:

7. Introduction and terminologies, quality and quantity of light. Necessity of artificial lighting, combination of day light and artificial lighting. Methods of lighting- accent, ambient and task lighting.
8. Various types (incandescent, fluorescent/CFL, HID's, neon lamps) and selection criteria considering their temperament for residential, commercial, industrial, public buildings, for street and landscape lighting. Criteria's for selecting lamps for different occupancies.
9. Lighting design for different types of occupancies - landscape, parking areas, different tasks, street lighting, commercial building, residence.

Scheme for Internal semester assessment (ISA)

Regular Assignments, models.

Term work: Evaluation of Portfolio, assignments by internal examiner

Scheme for End Semester Assessment (ESA)

External examination-3 hrs



Title: Curriculum Content- Course wise

Page 24 of 28

Year:2021-22

Mode of assessment: Portfolio& Theory exam.

Reference books:

1. H Cotton, Electrical Technology
2. L. Uppal, Electrical wiring, Estimating & Costing
3. Anwari., Electrical Engg.
4. M.S.N. Swamy, Lighting, MSN Marketing, Bangalore.
5. Torquil Barker, Concepts in Practice lighting, 1997, B.T. Batsford Ltd, 583, fullham Road, London.
6. Dr. Frith Abnws and others. Electrical Engineering handbook.
7. S.L.Uppal and G.C. Garg. Electrical wiring (Estimating & Costing), Khanna Publishers, New Delhi.
8. Manufacturers catalogues and journals.

Scheme for End Semester Assessment (ESA)

Sl.No	8 Questions to be set of 20 Marks Each	Chapter Number	Instructions
I	Q.No.-1, Q.No.-2, Q.No.-3	1, 2,3	Solve Any 2 out of 3
II	Q.No.-4, Q.NO – 5 Q.No.-6,	4,5, 6	Solve Any 2 out of 3
III	Q.No.-7, Q.No.-8	7,8	Solve Any 1 out of 2

 KLE Technological University Creating Value Leveraging Knowledge	Document #: FMCD2005	Rev: 1.0
	Title: Curriculum Content- Course wise	
		Page 25 of 28
		Year:2021-22

Program: Architecture		
Course Title: HISTORY OF ARCHITECTURE - III		Course Code: 18AATC211
L-S-P: 2-0-0	Credits: 2	Contact Hours: 2
ISA Marks:50	ESA Marks: 50	Total Marks: 100
Teaching Hours: 32	Examination Duration: 3 HOURS	
Course contents UNIT I: Evolution of Imperial Indian Islamic Architecture in the following dynastic rule of Imperial style (Slave, Khilji, Tughlaq, Sayyid and Lodi) – E.g.Quwwat-ul-Islam Mosque, Qutub-Minar, Enlargement of Quwwat-ul-Islam Mosque by Iltutmish, Tomb of Iltutmish, Enlargement of Quwwat-ul-Islam Mosque by Ala-ud-din Khilji and Alai Darwaza, Tomb of Ghiyas-ud-din Tughlaq, Khirki Masjid, Shish Gumbad, Tomb of Mubarak Shah Sayyid and Tomb of Sikandar Lodi.Provincial Style –I (Bengal and Jaunpur) – E.g. Adina Masjid, Pandua and Eklakhi Tomb, Pandua; Atala Masjid, Jaunpur and Jami Masjid, Jaunpur.Provincial Style -II (Gujarat and Malwa) E.g. Jami Masjid, Ahmedabad and Teen Darwaza, Ahmedabad , Jahaz Mahal, Mandu, Hindola Mahal, Mandu.		
UNIT II: Evolution of provincial Indian Islamic Architecture in the following provinces of Provincial Style –III (Bijapur)- E.g. GolGumbaz, Ibrahim Rauza and Jami Masjid, BijapurMughal Architecture-Phase I - E.g. Humayun’s Tomb, Delhi; Fatehpur Sikri (Layout and Diwan-i-khas, Jodhabai Palace, Jami Masjid, Tomb of Salim Chisti and Buland Darwaza)Mughal Architecture-Phase II - E.g. Akbar’s tomb, Sikandra, TajMahal, Agra - Layout of the Tomb and the concept of Charbagh		
UNIT III: Evolution of Indian British Colonial architecture in the dynastic rule of Early British Colonial Style - E.g. St Paul’s Cathedral, Calcutta, Victoria Memorial, Calcutta, Bombay Town Hall, Bombay. Late British Colonial Style - E.g. Layout of New Delhi, Rashtrapati Bhavan and Parliament House.		
Scheme for Internal semester assessment (ISA) Tests, Quiz, Assignments by internal examiner		
Scheme for Semester End Assessment (ESA) External examination-3 hrs		
Mode of assessment: Portfolio& Theory exam.		
Text Books: NIL		
Reference Books: <ol style="list-style-type: none"> 1. Tadgell Christopher, The History of Architecture in India from the Dawn of civilization to the end of the Raj; Phaidon Press, London, U.K. Ltd., 2002 onwards. 2. Brown Percy, Indian Architecture (Islamic Period) Vol II; DB Taraporevala and Sons Co.Pvt. Ltd., Bombay, 1983 and subsequent publications. 3. Grover Satish, Islamic Architecture in India, Galgotia Publications, India, 1996 onwards. 4. Stierlin Henri, Stierlin Anne, Islamic Art and Architecture, Thames & Hudson, 2002 onwards. 5. Ferguson, J.A., Encyclopedia of World Architecture (Islamic Architecture), Aryan books, 1998 onwards. 6. Fletchers Banister, A History of Architecture, C.B.S.Publishers, 1996 onwards. 7. Tillotson, G.H.R. , The Tradition of Indian Architecture: Continuity, Change and the Politics of Style since 1850, Oxford University Press, Delhi, 1989 onwards. 8. Tomory Edith, A History Of Fine Arts In India And The West, Orient Blackswan Pvt Ltd.-(New Delhi), 2009 onwards. 9. Asher Catherine B., Architecture of Mughal India, Cambridge, 1995 onwards 		



Title: Curriculum Content- Course wise

Page 26 of 28

Year:2021-22

Scheme for End Semester Assessment (ESA)

Sl.No	8 Questions to be set of 20 Marks Each	Chapter Number	Instructions
I	Q.No.-1, Q.No.-2, Q.No.-3	1, 2,3	Solve Any 2 out of 3
II	Q.No.-4, Q.NO – 5 Q.No.-6,	4,5, 6	Solve Any 2 out of 3
III	Q.No.-7, Q.No.-8	7,8	Solve Any 1 out of 2



Title: Curriculum Content- Course wise

Page 27 of 28

Year:2021-22

Program : Architecture		
Course Title: THEORY OF ARCHITECTURE		Course Code: 18AATC212
L-S-P: 2-0-0	Credits: 2	Contact Hours: 2
ISA Marks: 50	ESA Marks: 50	Total Marks: 100
Teaching Hours: 32	Examination Duration: 3 HOURS	
<p>UNIT I: 8 hours</p> <ol style="list-style-type: none"> Underlying Organizing Principles: Linear, centralized, radial, Clustered, Grid. Underlying Spatial Organizing Principles: Space within space, Adjacent space and Interlocked space 		
<p>UNIT II: 20 hours</p> <ol style="list-style-type: none"> Theory in Antiquity of Vitruvius Theory in Renaissance of Leon Alberti and Andrea Palladio. Theory in 18th century Violet-le-Duc , Gottfried Semper 		
<p>UNIT III: 4 hours</p> <ol style="list-style-type: none"> Theories on built environment. Architectural Criticism. 		
<p>Text Books: NIL</p>		
<p>Reference Books:</p> <ol style="list-style-type: none"> Francis D K Ching, Form Space and Order Parmar V S, Design Fundamental in Architecture J.M.Zunde ,Design Procedures – level 4 Vitruvius :Ten Books on Architecture Alberti Leon: Ten Books on Architecture Christian Norberg Shulz, Genius Loci William: Modern Architecture since 19th century Alexander Christopher: Timeless way of Building Rappoport Amos: House Form and Culture Rappoport Amos: Meaning of the built environment Geoffrey Broadbent: Design in Architecture Geoffrey Baker: Design strategies in architecture: An approach to analysis of form Attoe Wayne: Architectural and critical imagination Lynch Kevin:City Sense Lynch Kevin: Image of the City Alexander Christopher ;Urban Pattern 		



Title: Curriculum Content- Course wise

Page 28 of 28

Year:2021-22

17. Alexander Christopher: New Theory of Urban Design
18. Alexander Christopher: Nature of Order,vol.1,2,3
19. Alexander Christopher: Synthesis of Form
20. Alexander Christopher: City is not a Tree
21. Rappoport Amos: Human Aspect of Urban Form
22. Rappoport Amos: History and Precedent of Environmental Design
23. Bernard Rudofsky,Architecture without Architects .a short introduction to Non-Pedigreed Architecture. Academy Edition London
24. Alberti Leon: Ten Books on Architecture
25. Sociologic of space
26. Attoe Wayne: Architectural and critical imagination
27. Hale A Jonathan: Building Ideas, An introduction to Architectural Theory



Title: Curriculum Content- Course wise

Page 29 of 28

Year:2021-22

Program : Architecture

Course Title: Quantity survey and specifications.

Course Code: 18AATC213

L-S-P: 2-0-0

Credits: 2

Contact Hours: 4

ISA Marks: 50

ESA Marks: 50

Total Marks: 100

Teaching Hours: 56

Examination Duration: 3 Hours

Course contents

Unit - I

- 1)Types of Estimates
- 2) Detailed estimates for load bearing buildings.

Unit - II

- 3) Detailed estimates for R C C frame structure buildings.
- 4) Introduction to Schedule of Rates.
- 5) Rate analysis.

Unit – III

- 6) Abstract Specifications for building constructions.
- 7)Schedule of rates.

Scheme for Internal semester assessment (ISA)

Term work: Evaluation of Portfolio, assignments by internal examiner

Scheme for End Semester Assessment (ESA)

External examination-3 hrs

Mode of assessment :

Portfolio& Theory exam.

Text Books: NIL

Reference Books:

1. Datta B N

Scheme for Semester End Examination (ESA)

SI.No	8 Questions to be set of 20 Marks Each	Unit Number	Instructions
1	Question Numbers 1, 2 & 3	I	Solve Any 2 out of 3
2	Question Numbers 3, 5 & 6	II	Solve Any 2 out of 3
3	Question Numbers 7 & 8	III	Solve Any 1 out of 2

 KLE Technological University Creating Value Leveraging Knowledge	Document #: FMCD2005	Rev: 1.0
	Title: Curriculum Content- Course wise	
		Page 30 of 28
		Year:2021-22

Program : Architecture		
Course Title: STRUCTURES - IV		Course Code: 18AATC214
L-S-P: 3-0-0	Credits: 3	Contact Hours: 3
ISA Marks: 50	ESA Marks: 50	Total Marks: 100
Teaching Hours: 48	Examination Duration: 3 HOURS	
Course contents		
UNIT I:		
Structural steel properties, available steel grades in India, loads on steel structures as per IS 875- 1987 (Part I and II) and standard rolled steel sections.		
Fasteners – welded, bolt and nut connections in steel structures, to find the strength of a joint may be subjected to axial load and eccentric load. Merits and demerits as compared to each other.		
UNIT II:		
3. Design of roof truss elements strut and tie.		
4. Design of elements of braced steel structural system, compression members of single and built up sections. Design of compression members using SP 6 part I.		
5. Design of slab base and foundation subjected to axial load.		
UNIT III:		
6. Design of laterally restrained beams.		
7. Moment resisting frames, comparison with braced frames, different types, composite structures.		
8. Case study of steel building structures.		
Scheme for Internal semester assessment (ISA)		
Regular assignments by internal examiner		
Scheme for End Semester Assessment (ESA)		
External examination-3 hrs		
Mode of assessment :		
Portfolio & Theory exam.		
Text Books:		
1. <i>Ram Chandra Design of Steel Structures Vol I Standard Publishers New Delhi</i>		
Reference Books:		
1. P Dayaratnam Design of Steel Structures S Chand Publications New Delhi . 1999		
2. Vaziranzi & Ratwani Design of Steel Structures Khanna Publications New Delhi. 1998		
3. Duggal. Design of Steel Structures Tata McGraw Hill Publications New Delhi . 1999		
4. I.S.875-1978		
5. S.P.6 (6)		
6. IS 800 - 1984		



Title: Curriculum Content- Course wise

Page 31 of 28

Year:2021-22

Scheme for End Semester Assessment (ESA)

Sl.No	8 Questions to be set of 20 Marks Each	Chapter Number	Instructions
I	Q.No.-1, Q.No.-2, Q.No.-3	1, 2	Solve Any 2 out of 3
II	Q.No.-4, Q.No. – 5 Q.No.-6,	3, 4, 5	Solve Any 2 out of 3
III	Q.No.-7, Q.No.-8	6, 7, 8	Solve Any 1 out of 2



Title: Curriculum Content- Course wise

Page 32 of 28

Year:2021-22

Program : Architecture

Course Title: Elective – Space, Culture & Architecture

Course Code: 18AATE201

L-S-P: 0-1-0

Credits: 1

Contact Hours: 2

ISA Marks: 50

ESA Marks: 50

Total Marks: 100

Teaching Hours: 28

Examination Duration: NA

Course contents

UNIT I:

Introduction to Space, Culture & Architecture Sociological theories and cultural theories in relation to architecture
Critical thinking – its basis and intent

UNIT II:

Study and analysis of few Important Architectural Spaces of Cultural Significance Study and Documentation of Cultural Landscape.

UNIT III:

Research Paper on Space, Culture & Architecture

Scheme for Internal semester assessment (ISA)

Field work Ideation, Concept design, Final Design Periodic reviews presentations of finding , concerns, Development stage of product and justification

Scheme for End Semester Assessment (ESA)

Final Report Prototype design

Mode of assessment :

Field work attendance
Assignment

Text Books:NIL

Reference Books:

- 1) J Habraken *Sociologic of space*
- 2) Rappoport Amos: *House Form and Culture*



Title: Curriculum Content- Course wise

Page 33 of 28

Year:2021-22

Program : Architecture

Course Title: Elective – Human Centered Design - I

Course Code: 18AATE202

L-S-P: 0-1-0

Credits: 1

Contact Hours: 2

ISA Marks: 50

ESA Marks: 50

Total Marks: 100

Teaching Hours: 28

Examination Duration: NA

Course contents

Understanding Design as a very old human capability that has been forgotten by the mainstream educational system and traditionalist alike. A modern human activity that can help the products, services and policies of the future within the constraints of our contexts.

UNIT I:

What is Design? Multiple Dimensions of Design, Processes and Applications
What is Human Centered Design? 1 Looking: Observing Human Experience
2 Understanding: Analyzing challenges and opportunities
3 Making: Envisioning Future Possibilities

UNIT II:

HCD to identify problem.

UNIT III:

Field Work, Define, Ideate, Prototype (Concept design, Detailed Design) ,Test, Feedback

Scheme for Internal semester assessment (ISA)

Field work Ideation, Concept design, Final Design Periodic reviews presentations of finding , concerns, Development stage of product and justification

Scheme for End Semester Assessment (ESA)

Final Report Prototype design

Mode of assessment :

Field work attendance
Assignment

Text Books:NIL

Reference Books:

1. Harold Nelson: The Design Way Intensions /Compositions/Value
2. John Heskett :Toothpics and Logos
Objects/Communication/Environments/Identities/Systems/Contexts/Future
3. Klaus Krippendorff:The Semantic Turn ,Meaning of Artifact in :Use/Language/Life Cycle/Ecology



Title: Curriculum Content- Course wise

Page 34 of 28

Year:2021-22

Program : Architecture

Course Title: Elective – Biomimicry in Architecture

Course Code: 18AATE203

L-S-P: 0-1-0

Credits: 1

Contact Hours: 2

ISA Marks: 50

ESA Marks: 50

Total Marks: 100

Teaching Hours: 28

Examination Duration: NA

Course contents:

Unit-I:

Introduction, History, characteristics, Types and approaches to Biomimicry.

UNIT II:

Introduction of Biomimicry principles and Technology towards sustainable development in architecture, Case studies.

UNIT III:

Application of Biomimicry Principles in Architecture

Scheme for Internal semester assessment (ISA)

Field work Ideation, Concept design, Final Design Periodic reviews presentations of finding , concerns, Development stage of product and justification

Term work: Evaluation of Portfolio, assignments by internal examiner

Scheme for End Semester Assessment (ESA)

Final Report Prototype design

Evaluation of Portfolio, assignments by internal and external examiners

Mode of assessment :

Field work attendance

Assignment

Text Books:NIL

Reference Books:

1. Michael Pawlyn, "Biomimicry in Architecture", Riba Publishing, 2nd Edition, 2016
2. Janine M Benyus ,Biomimicry: Innovation Inspired by Nature, ISR Journal,



Title: Curriculum Content- Course wise

Page 35 of 28

Year:2021-22

Program : Architecture

Course Title: Elective – Digital Rendering

Course Code: 18AATE204

L-S-P: 0-1-0

Credits: 1

Contact Hours: 2

ISA Marks: 50

ESA Marks: 50

Total Marks: 100

Teaching Hours: 28

Examination Duration: NA

Course contents:

Unit-I:

Digital Rendering Techniques

Rendering techniques of plans, elevations§ions using digital tool.

Unit-II

Detail Rendering

Adding details like human figures, furniture, trees, vehicles etc.

Unit-III

Publish to various media

Various print and web file formats

Sessional Work (Internal semester assessment)

Regula Assignments and Rendered Drawings

Scheme for Semester End Assessment (ESA)

Term work: Evaluation of Portfolio, assignments by internal and external examiners

Mode of assessment: Soft copy and printed version.

References :

Course contents:

Unit-I:

Digital Rendering Techniques

Rendering techniques of plans, elevations§ions using digital tool.



	FORM ISO 9001: 2008-KLETU School of Architecture	Document #: FMCD2005	Rev: 1.0
	Title: Curriculum Content- Course wise		Page 1 of 28 Year:2021-22

**School of Architecture,
KLE Technological University,
BVBCET Campus, Vidyanagar, Hubli.**

CURRICULUM SCHEME & SYLLABUS OF **V Semester – VI Semester**

(Year of introduction-2015, Faculty-A, Architecture-AT, Core course-C, Humanities-H, Lab-L, Elective-E, internship-I, Practice-p, W-Project)

	FORM ISO 9001: 2008-KLETU School of Architecture	Document #: FMCD2005	Rev: 1.0
	Title: Curriculum Content- Course wise		Page 2 of 28
			Year:2021-22

Semester: V (2019-20)

Sr.No	Course code	Course Title	Period			Evaluation scheme			Credit (L+T+P)	Hours
			L	T	P	ISA	ESA	Sub total		
1	18AATC301	Architectural Design V	0	6	0	50	50	100	6	9
2	18AATC302	Building Construction & Materials V	0	4	0	50	50	100	4	6
3	18AATC303	Services III (HVAC)	2	0	0	50	50	100	2	2
4	18AATC304	Modern Architecture	2	0	0	50	50	100	2	2
5	18AATC305	Working Drawing	0	2	0	50	50	100	2	4
6	18AATC306	Landscape Design	0	2	0	50	50	100	2	2
7	18AATC307	Structures – V	3	0	0	50	50	100	3	3
8	18AATE301 -304	Elective- II	0	1	0	50	50	100	1	2
TOTAL			7	15	0	400	400	800	22	30

ISA: In-semester Assessment **ESA:** End Semester Assessment **L:** Lecture **T:** Tutorials **P:** Practical

Credit	Lecture Hours	Studio Hours	Practical Hours
1	1	1.5	2

Program Head

Signature of Dean (Academic Affairs)

	FORM ISO 9001: 2008-KLETU School of Architecture	Document #: FMCD2005	Rev: 1.0
	Title: Curriculum Content- Course wise		Page 3 of 28
			Year:2021-22

Semester: VI (2019-20)

Sr.No	Course code	Course Title	Period			Evaluation scheme			Credit (L+T+P)	Hours
			L	T	P	ISA	ESA	Sub total		
1	18AATC308	Architectural Design VI	0	6	0	50	50	100	6	10
2	18AATC309	Building Const & Materials VI	0	4	0	50	50	100	4	6
3	18AATC310	Services IV (Acoustic)	2	0	0	50	50	100	2	2
4	18AATC311	Contemporary Architecture	2	0	0	50	50	100	2	2
5	18AATC312	Settlement Planning	2	0	0	50	50	100	2	2
6	18AATC313	Interior Design	0	2	0	50	50	100	2	3
7	18AATC314	Structures – VI	3	0	0	50	50	100	3	3
8	18AATE308 TO 312	Elective- III	0	1	0	50	50	100	1	2
TOTAL			9	13	0	400	400	800	22	30

ISA: In-semester Assessment **ESA:** End Semester Assessment **L:** Lecture **T:** Tutorials **P:** Practical

Credit	Lecture Hours	Studio Hours	Practical Hours
1	1	1.5	2

Program Head

Signature of Dean (Academic Affairs)

 KLE TECH	FORM ISO 9001: 2008-KLETU School of Architecture	Document #: FMCD2005	Rev: 1.0
Title: Curriculum Content- Course wise			Page 4 of 28
			Year:2021-22

 KLE TECH	FORM ISO 9001: 2008-KLETU School of Architecture	Document #: FMCD2005	Rev: 1.0
Title: Curriculum Content- Course wise			Page 5 of 28 Year:2021-22

V SEMESTER

	FORM ISO 9001: 2008-KLETU School of Architecture	Document #: FMCD2005	Rev: 1.0
	Title: Curriculum Content- Course wise		Page 6 of 28 Year:2021-22

Program: Architecture		
Course Title: Architectural Design – V		Course Code: 18AATC301
L-T-P – 0-6-0	Credits: 6	Contact Hours: 9 Hrs
ISA Marks: 50	ESA Marks: 50	Total Marks: 100
Teaching Hours:126 Hrs	Examination Duration: NA	
<p>Course contents:</p> <p>To develop skills for comprehensive understanding and dealing with Architecture and to provide skills for designing multi-user and multi-level spaces. To emphasize upon the role of construction in evolving expression. To focus on design detail as vital part of architectural expression in the urban context. To integrate building systems and effective communication of legible drawings.</p> <p>The design issues to be addressed are</p> <ul style="list-style-type: none"> • Multi user and multi-level space formation • The integration of design, structure, services, etc • Integrate the horizontal and vertical circulation. • Develop skills to correlate the materials and the resulting form. • Integration of material, form and the appropriate building envelope. • The architectural details of the building materials and assemblies. • Details pertaining to the disabled, aged people and children. <p>The list of suggested spaces to be covered as design problems: Architectural Exhibition / display spaces Multi level Accommodation spaces, higher level academic spaces, multi activity Recreational spaces, Neighbor hood Community spaces, Healthcare Centers etc.</p> <p>Necessary theoretical inputs to be given highlighting the norms and design issues. At least one major exercise and one minor design/ time problem should be given. The topics covered as design problems will have to be covered by the studio faculty members through lecture/slide show session and site visits.</p>		
<p>Unit I</p> <p>Design Analysis : Research of the given design project, Analysis of precedents</p> <p>Site analysis / Concept Development:Site plan, Site analysis, site synthesis and zoning, Metaphors in design process and formulation of design brief, conceptual sketches, design development.</p> <p>Preliminary Design Development stage : Schematic drawings of plans with furniture Layout, sections, elevations and study models. Parametricism for form finding, by changing the variables. 3D modeling and various types of surface modeling.</p>		
<p>Unit II</p> <p>Secondary Design Development stage : Development of detail plans, elevations and sectional details, Models, Development of Three dimensional massing with corresponding fenestrations, etc. through visual programming language (VPL) Grasshopper that is a plug-in running within Rhinoceros 3D modeling software.</p>		

	FORM ISO 9001: 2008-KLETU School of Architecture	Document #: FMCD2005	Rev: 1.0
	Title: Curriculum Content- Course wise		Page 7 of 28 Year:2021-22

Unit III

Finalization of design : Presentation (computer aided) and rendering

Esquissee : Given design topic to be completed within the time limit.

Model Making : Final three dimensional model/views Parametric design with the powerful visual programming languages. Grasshopper that is a plug-in running within Rhinoceros.

Text Books: NIL

Reference Books:

1. Time Saver Standard for Architectural Data by John Hancock.
2. Architectural Graphic Standards by Ramsey and Sleeper.
3. Magazines and Design related books
4. Architecture: Form, Space and Order, Ching, Francis DK
5. Design and Form: The basic course at the Bauhaus, Itten, Johannes.
6. Elements of space forming, Yatin Pandya.
7. Architectural Composition, Krier, Rob
8. Le Corbusier- An analysis of form. Geoffrey Baker.
9. Design Thinking process and methods. Rob Curedale.

Scheme for Semester End Examination (ESA)

Evaluation of Portfolio, assignments by internal and external examiners

The students have to present the entire semester work for assessment along with Models.

A viva-voce (Approximate 15 minutes /student) shall be conducted by a jury comprising of an external examiner and an internal examiner. The drawings, models and shall be presented by the student.

Semester: Vth Sem-B.Arch

Course name: Building Construction and Materials-V

Credits: 4 Teaching hrs/week: 6 hours

Course Overview: To Familiarise Students with the Various types of RCC Slabs with reinforcement details, Flat Slab, Vaults & Domes, Various Types of Staircases with Details, Composite Construction technology & details, Vierendiel RCC Girders.

Chapters No	Course Objectives	Existing Content	Proposed Content	%age Change in the Content
Unit-I				
Chapter-1	➤ Analyze the basic principles and appropriate application and performance of building envelope materials and	Doors for large openings: Sliding and folding doors in timber, Sliding door using standard aluminum and PVC sections. Definition, Characteristics, Comparison, Design and Construction details.	➤ RCC Slabs: Introduction to types & selection criteria of slabs like i) spanned in one direction ii) spanned in both directions i.e. iii) continuous iv)	100%

	FORM ISO 9001: 2008-KLETU School of Architecture	Document #: FMCD2005	Rev: 1.0
	Title: Curriculum Content- Course wise		Page 8 of 28 Year:2021-22

	assemblies and to assess, select in to building design ➤ Ability to select & make appropriate application of construction materials, products, components, assemblies including their environmental impact and reuse.		cantilever v) slope vi) ribbed vii) coffered vii) filler, showing construction & reinforcement arrangements.	
Chapter-2		Doors for large openings: Metal doors like rolling shutter, fabricated door, grilled door Definition, Characteristics, Comparison, Design and Construction details.		
	➤ Ability to represent the materials & details graphically.			
Unit-II				
Chapter-3		Metal and PVC windows: Windows fabricated with standard Z and pressed sheet metal, aluminium section windows fabricated with standard PVC sections.	➤ FLAT SLAB: Introduction to, advantages over regular slabs, including construction details & reinforcement arrangements for i) solid slab ii) drop panel iii) flared column top.	100%
Chapter-4		Partitions Partitions using various materials and their combinations like : timber, metals, PVC, plywood, glass, gyp board etc.	➤ VAULTS & DOMES: Introduction to types, Construction Details & Futuristic Revival.	100%
Chapter-5		False Ceiling False ceiling using various materials and their combinations for frame work and panels like :timber, metals, PVC, POP, plywood, glass, polystyrene etc.	➤ STAIRCASE: Types, Geometry of the Components, Sketches giving details of Geometry and Reinforcement for Waste slab Stair, Stringer Beam Stair,	100%
Chapter-6		False floor False floor using various		

	FORM ISO 9001: 2008-KLETU School of Architecture	Document #: FMCD2005	Rev: 1.0
	Title: Curriculum Content- Course wise		Page 9 of 28 Year:2021-22

		materials and their combinations for framework & panels like: timber, metals, plywood, glass etc.	Cantilever Step Stair, and <u>Folded Plate Stair</u> for Dog Legged, Open Newell, Quarter Turn and Spiral Stairs.	
Unit-III				
Chapter-7		Wall panelling Wall panelling using various materials like stone slabs, timber, plywood, metal, composite boards PVC etc.	➤ Composite Constructions: Concepts, Different types of the Composite Constructions, Sketches showing details & Construction Methods.	100%
Chapter-8		Materials Materials like glass & glass products, plastics, rubber. Their manufacturing in brief, properties & Architectural Application.	➤ Veirendiel Girders in R.C.C., Beams of Varying Cross- Sections & Applications.	100%

Chapter No.'s	Existing Evaluation Methods	Proposed Evaluation Methods	Mode of Assignments
Unit-I			
Chapter-1	Submissions / Assignments	Submissions (30%) / Assignments (20%) / Examinations (50%).	Submissions / Assignments / Examinations
Chapter-2	Submissions / Assignments	Submissions (30%) / Assignments (20%) / Examinations (50%).	Submissions / Assignments / Examinations
Unit-II			
Chapter-3	Submissions / Assignments	Submissions (30%) / Assignments (20%) / Examinations (50%).	Submissions / Assignments / Examinations
Chapter-4	Submissions / Assignments	Submissions (30%) / Assignments (20%) / Examinations (50%).	Submissions / Assignments / Examinations
Chapter-5	Submissions / Assignments	Submissions (30%) / Assignments (20%) / Examinations (50%).	Submissions / Assignments / Examinations
Chapter-6	Submissions / Assignments	Submissions (30%) / Assignments (20%) / Examinations (50%).	Submissions / Assignments / Examinations
Unit-III			

	FORM ISO 9001: 2008-KLETU School of Architecture	Document #: FMCD2005	Rev: 1.0
	Title: Curriculum Content- Course wise		Page 10 of 28 Year:2021-22

Chapter-7	Submissions / Assignments	Submissions (30%) / Assignments (20%) / Examinations (50%).	Submissions / Assignments / Examinations
Chapter-8	Submissions / Assignments	Submissions (30%) / Assignments (20%) / Examinations (50%).	Submissions / Assignments / Examinations

Teaching / Learning Methodology	Course Outcomes		
	1	2	3
Lectures / Tutorials	Yes	Yes	Yes
Assignments	Yes	Yes	Yes
3d Models / Projects	Yes	Yes	Yes

Program : Architecture		
Course Title: BUILDING CONSTRUCTION&MATERIALS- V		Course Code: 18AATC302
L-S-P: 0-4 -0	Credits: 4	Contact Hours: 6
ISA Marks: 50	ESA Marks: 50	Total Marks: 100
Teaching Hours: 84	Examination Duration: NA	

	FORM ISO 9001: 2008-KLETU School of Architecture	Document #: FMCD2005	Rev: 1.0
	Title: Curriculum Content- Course wise		Page 11 of 28 Year:2021-22

UNIT I: DOORS FOR LARGER OPENINGS

Folding Door in Timber. Sliding Door in Aluminum and PVC
 Various types of Doors in steel viz Rolling shutter, fabricated in Pressed M.S. Sheet panel.

UNIT II: METAL AND PVC WINDOWS

Various types of Windows in steel fabricated pressed metal (box) sections.
 Sliding windows in Aluminum and UPVC including safety arrangement.

UNIT III: PARTITIONS AND FALSE CEILINGS

Partition systems using various materials like Timber, metal, UPVC, various boards, glass etc.
 False ceiling system with Timber, metal framing and various panel materials.
 False flooring systems.

Materials:-

Properties, types, manufacturing in brief and architectural uses of glass, and glass products and Plastics.

Note – The Portfolio covering the above topics shall be presented for Term work. Site visits shall be arranged by studio teacher. Study of material application shall be submitted in the form of notes, sketches and photo brief as a part of portfolio.

Text Books: NIL

Reference Books:

- McKay J.K Building Construction Metric Vol 1-4, 4thedi Orient Longman Pvt. Ltd, Mumbai,2002
 - “Construction Technology” volume-I by R Chudley, ELBS & Longman group Ltd.
 - Barry R, “The construction of buildings”, Vol-2, 5th Edi, East West Press, New Delhi 1999.
 - Bindra S.P and Arora S.P, Building Construction-Planning Techniques and Method of Construction, 19thedi, Dhanpat Rai Pub ,New Delhi, 2000
 - “Building Construction” by JanardhanJha, Khanna New-Delhi.
 - Rangawal S.C ,“Building Construction” 22nd Edi, charotar Publishing house, Anand, 2004
 - “Engineering Materials” by Surendra Singh, Vikas Delhi.
 - “Building Materials” by S K Duggal, IBH New Delhi.
 - Sushil Kumar T.B of Building Construction 19thedi, Standard Pub House, New Delhi, 2003.
 - Chowdhary K.P. Engineering Materials used in India, 7th Edi, Oxford and IBH Pub ltd New Delhi, 1990.
- Building Construction Hand book : By R Chudly& R Greeno, Bullerworth Heinemann, New-Delhi

Program: Architecture		
Course Title: SERVICES – III (HVAC)		Course Code: 18AATC303
L-T-P: 2 – 0 - 0	Credits:2	Contact Hours: 2 Hrs
ISA Marks: 50	ESA Marks: 50	Total Marks: 100
Teaching Hours: 28 Hrs	Examination Duration: 3 Hours	
Unit I		
Introduction to Passive and Mechanical ventilation:		
1. Passive & Mechanical ventilation - Need for mechanical ventilation in buildings, Applications in different		

 FORM ISO 9001: 2008-KLETU School of Architecture	Document #: FMCD2005	Rev: 1.0
		Page 12 of 28
		Year:2021-22

situations. Air conditioning – Definition, Refrigeration cycle, Compressor, Condenser, Evaporator in Air-Conditioning system.

- Different types of Air Conditioning system** – Ductable and non ductable air conditioners, Location analysis of different equipments in different types of buildings. Air distribution systems- ducts, diffusers etc.
- Factors responsible for calculation of air conditioning load. Application of appropriate AC system for different types of occupancies like Residential, commercial, industrial etc.

Unit II

- Elevators:** Introduction, different types of elevators like traction, hydraulic, double deck elevators, sky lobby, structure and interiors of lifts. Passenger handling capacity, space and physical requirement and layout. Locational analysis of elevators, grouping of elevators.
- Escalators:** Definition, structure and different parts of escalator, application, Location and arrangement in different types of buildings.

Unit III

- Fire safety of buildings:** Safety Measures against fire role of architect in providing fire safety to buildings and fire resisting materials. Passive fire protection in different categories of buildings. Importance of fire hazards, fire load, fire precaution and fire prevention. Provision of smoke detectors and fire alarms. Difference between firefighting and fire prevention.
- Active fire protection:** Extinguishers, sprinklers, firefighting lobby etc; Systems adopted in various buildings against fire. Case studies: Case studies of some fire disasters and their reasons: Fire Norms by NBC, Calculation of Occupant load and min. doorway width, Calculation of Fire exits, Concept of Pressurization, Fire lifts and Fire Staircases regulations etc as per bye-law.

Reference Books:

- P. N. Anant Narayana., *Refrigeration and Air conditioning*, Third edition, Tata McGraw-Hill publishing Company Ltd, New Delhi.
- Manohar Prasad., *Air conditioning and Refrigeration Data Hand book*.
- Blue star Ltd: *Blue star Guide to Comfort Air conditioning*. India Published by Packaged Air conditioning division.
- Roy J Dosat., *Principles of Refrigeration*.
- Dagostino, F. R:(1982) *“Mechanical and Electrical systems in Building”* Varginia, Reston Publishing Co.

Scheme for Semester End Examination (ESA)

UNIT	8 Questions to be set of 20 Marks Each	Chapter numbers	Instructions
I	Question Numbers 1, 2 & 3	I	Solve Any 2 out of 3
II	Question Numbers 3, 5 & 6	II	Solve Any 2 out of 3

 FORM ISO 9001: 2008-KLETU School of Architecture	Document #: FMCD2005	Rev: 1.0
		Page 13 of 28
		Year:2021-22

III	Assignment	III	Design application Solve 1 OUT OF 1
-----	-------------------	-----	-------------------------------------

Program : Architecture		
Course Title: Modern Architecture		Course Code: 18AATC304
L-S-P: 2-0-0	Credits: 02	Contact Hours: 02 Hrs
ISA Marks: 50	ESA Marks: 50	Total Marks: 100
Teaching Hours: 28 Hrs	Examination Duration: 3 Hrs	

	FORM ISO 9001: 2008-KLETU School of Architecture	Document #: FMCD2005	Rev: 1.0
	Title: Curriculum Content- Course wise		Page 14 of 28 Year:2021-22

UNIT I:

- Transitional period and Revival architecture
- Early Industrial buildings.
- The Chicago school and Italian Futurism

UNIT II:

- De Style and Bauhaus
- Ideas and Works of Frank Lloyd Wright and Mies Van Der Rohe,
- Ideas and Works of Le Corbusier and Louise Kahn in India.

UNIT III:
Post-independence Modern Architecture in India.

- Ideas and Works of architects Achyut Kanvinde, B. V. Doshi and Charles Correa
- Ideas and Works of architects Raj Rewal, Uttam Jain and Laurie Baker.

NOTE:

The architects and ideas mentioned above are indicative only

The course teacher may choose the ideas and works of architects to explain modern architecture.

Text Books: Nil

Reference Books:

1. Kenneth Frampton, Modern Architecture- A critical History
2. Bannister Fletcher, History of Architecture William Curtis, Modern Architecture since 1900
3. William Curtis, Modern Architecture since 1900
4. Bannister Fletcher, History of Architecture

Scheme for Semester End Examination (ESA)

Sl.No	8 Questions to be set of 20 Marks Each	Unit Number	Instructions
1	Question Numbers 1, 2 & 3	I	Solve Any 2 out of 3
2	Question Numbers 3, 5 & 6	II	Solve Any 2 out of 3
3	Question Numbers 7 & 8	III	Solve Any 1 out of 2

Program : Architecture		
Course Title: Working Drawing		Course Code: 18AATC305
L-S-P: 0-2-0	Credits: 2	Contact Hours: 4 Hrs
ISA Marks: 50	ESA Marks: 50	Total Marks: 100

	FORM ISO 9001: 2008-KLETU School of Architecture	Document #: FMCD2005	Rev: 1.0
	Title: Curriculum Content- Course wise		Page 15 of 28 Year:2021-22

Teaching Hours: 56Hrs	Examination Duration: NA
UNIT I: Introduction and importance of detailed working drawings in architectural practice. Creating working details for a residential / commercial project starting with foundation/footing and wall details	
UNIT II: Introduction to creating working details of doors, windows, staircase and floors	
UNIT III: Introduction to creating working details of interior, bathrooms, electrical & plumbing.	
Text Books:NIL	
Reference Books: Architectural Working Drawings: Residential and Commercial Buildings by William P. Spence Publisher: Wiley; ISBN-10: 0471574880 ISBN-13: 978-0471574880 Architectural Drawing: A Visual Compendium of Types and Methods (3rd edition) by Rendow Yee Publisher: Wiley; 3 edition (July 20, 2008) ISBN-10: 0471793663 ISBN-13: 978-0471793663 AutoCAD 2008 For Dummies. by David Byrnes, Mark Middle brook. Publisher: For Dummies; Revised edition (May 8, 2006) ISBN-10: 0471786497, ISBN-13: 978-0471786498	

Scheme for Semester End Examination (ESA)

Assignments, Checking of Portfolio of Term Work / Viva.

Program : Architecture		
Course Title: STRUCTURES – V		Course Code: 18AATC307
L-S-P: 3-0-0	Credits: 3	Contact Hours: 3
ISA Marks: 50	ESA Marks: 50	Total Marks: 100

 FORM ISO 9001: 2008-KLETU School of Architecture	Document #: FMCD2005	Rev: 1.0
		Page 16 of 28
		Year:2021-22

Teaching Hours: 42	Examination Duration: 3 HOURS	
UNIT I: 1. Introduction to the structural design project: Design of airport terminal building of dimension 50m X 100m as horizontal structural system. 2. Structural analysis and design: Determining the loads on structure as per IS 875-1984.Design of roofing system 3. Analysis and Design of continuous beams and slabs using IS:456-2000. Design of column and isolated foundation for axial load.		
UNIT II: 4. Structural behavior, classification and application of folded plates, shells, domes, pneumatic structures and tensile structures. 5. Study of typical reinforcement details of RCfolded plates, shells and domes. 6. Long span industrial building: Triangular and vierendeel roof truss structural system, general configuration of industrial building, spacing of trusses and design. Dead load, live load and wind load as per IS 875:1984 7. Cable and suspension structures: Design of long span system using cable and suspension system		
UNIT III: 8. Concept of pre stressed concrete; merits and demerits of PSC as compared to the RCC. Need of high strength concrete and steel for PSC. pre stressing systems, materials, behaviour of pre stressed concrete beams and losses in pre stress 9. Analysis of pre stressed concrete for self-weight, concentric tendons, eccentric tendon.		
Text Books:		
Reference Books: 1. S.R. Karve and V. L. Shah, Limit state theory and design of reinforced concrete structures publications Pune 2. Pre stressed concrete by Krishnaraju		

Program : Architecture		
Course Title: Vernacular Architecture (Elective)		Course Code: 18AATE301
L-T-P – 0 – 1 – 0	Credits: 1	Contact Hours: 2 Hrs
ISA Marks: 50	ESA Marks: 50	Total Marks: 100
Teaching Hours: 28 Hrs	Examination Duration: NA	
Unit I		

	FORM ISO 9001: 2008-KLETU School of Architecture	Document #: FMCD2005	Rev: 1.0
	Title: Curriculum Content- Course wise		Page 17 of 28 Year:2021-22

Introduction to Vernacular Architecture.

Definitions and theories, Categories, Contextual responsiveness: Climatic, Geographical, Anthropological and Cultural influences, Environment and Materials, Typical building materials, Built form & elements, Construction techniques & environmental performance.

Regional Variations in Built Form

Tribal Architecture Settlement Pattern, Dwelling Typology, Symbolism, Typical features, Construction materials and techniques. Illustrated case studies of vernacular settlements/building typology from various regions in India and abroad

Unit II

Documentation and Analysis of Vernacular built form

Documentation of Regional vernacular typology. Analysis of typology w.r.t Climate, Building materials & construction techniques, Geography, Anthropology, culture, etc

Unit III

Adaptations in Contemporary Architecture

Sustainable building materials and construction techniques, Works of Laurie Baker, Hasan Fathy, Gerard Da Cunha, etc

Internal semester assessment (ISA)

Field work Ideation, Concept design, Final Design

Periodic reviews presentations of finding , concerns, Development stage of product and justification

Text Books: Nill

Reference Books:

1. Paul Oliver (Ed), Encyclopedia of Vernacular Architecture of the world, vol 1,2,3, , Cambridge University Press, Cambridge, 2001
 2. Paul Oliver, Dwellings; The vernacular House worldwide, Cambridge University press, Cambridge, 2003
 3. Bernard Rudofsky , Architecture without architects, Great British, 1981
 4. Jain K,Jain M, Mud architecture of Indian desert, 2000
 5. Asquith I and Vellinga M, Vernacular Architecture in the Twenty first century , Taylor and Francis Oxon, 2006
 6. Tipnis Aishwarya, Vernacular traditions in contemporary architecture, Teri Press New Delhi, 2012
 7. Udamale. s., Architecture for Kutch, English Edition, Mumbai, 2003
 8. Brunskill, R. W. (1987). Illustrated Handbook of Vernacular Architecture. Castle Rock : Faber & Faber.
 9. Carmen, K. (1986). VISTARA – The Architecture of India. The Festival of India Publications.
 - 10.Cooper, I and Dawson, B. (1998). Traditional buildings of India. London : Thames & Hudson.
 - 11.Kenneth, F. (1983). Towards a Critical Regionalism: Six points for an architecture of resistance, In The Anti-Aesthetic: Essays on Postmodern Culture. (Ed.) Hal, F. Seattle : Bay Press.
 - 12.Muthiah, S., Meyappan, M., Ramswamy, V. and Muthuraman, V. (2000). The Chettiar Heritage. Chennai : Chettiar Heritage.
 - 13.Pramar, V. S. (1989). Haveli-Wooden Houses and Mansions of Gujarat, Ahmadabad : Mapin Publishing.
 - 14.Rapoport, Amos. (1969). House, Form & Culture. Eaglewood: Prentice Hall Inc.
- Tillotsum, G. H. R. (1989). The tradition of Indian Architecture: Continuity, Controversy and Change since 1850. Delhi: Oxford University Press.

Program : Architecture

Course Title: Bio-inspired Architecture

Course Code: 18AATE302

L-S-P: 0-1-0

Credits: 01

Contact Hours: 2 Hrs

 FORM ISO 9001: 2008-KLETU School of Architecture	Document #: FMCD2005	Rev: 1.0
		Page 18 of 28
		Year:2021-22

ISA Marks: 50	ESA Marks: 50	Total Marks: 100
Teaching Hours: 28 Hrs	Examination Duration: NA	
Course contents: Unit-I: What is bio-inspired architecture Unit-II: How bio-inspired architecture can solve design problems Examples of bio-inspired architecture Unit-III: How bio-inspiration can lead to sustainable architecture		
Sessional Work (Internal semester assessment) Evaluation of assignments in three stages		
Scheme for Semester End Assessment (ESA) Evaluation of assignments		
Mode of assessment : Evaluation of Portfolio, assignments by internal and external examiners		
References : Architectural design books, periodicals & websites		

 KLE TECH	FORM ISO 9001: 2008-KLETU School of Architecture	Document #: FMCD2005	Rev: 1.0
Title: Curriculum Content- Course wise			Page 19 of 28 Year:2021-22

VI SEMESTER

 FORM ISO 9001: 2008-KLETU School of Architecture	Document #: FMCD2005	Rev: 1.0
		Page 20 of 28
		Year:2021-22

Semester: VIth Sem-B.Arch

Course name: Building Construction and Materials-VI

Credits: 4

Teaching hrs/week: 6 Hours

Course Overview: To Familiarise Students with various types of Ferrous Metals, Various Steel Structures, Joints, Foundations, Splicing of Steel Members, Flextural Components, Roofing Components & Materials, Framed Steel Structures & Composite Construction with Protection to various Metals.

Chapters No	Course Objectives	Existing Content	Proposed Content	%age Change in the Content
Unit-I				
Chapter-1	<ul style="list-style-type: none"> ➤ Analyze and evaluate the structural steel construction concepts and apply them in the design projects. ➤ Apply principles of structural behavior in withstanding gravity and lateral forces along with the evolution, range, and appropriate selection of contemporary structural systems. ➤ Assess, select, and conceptually integrate steel structural systems into building design. 	Steel structures: Various structural steel sections and its use as single or composite for vertical & horizontal members. Methods of connecting steel sections.	<ul style="list-style-type: none"> ➤ Ferrous Metals: Types, Properties & Application in Architecture. CI, MS & WI, Different Steels. ➤ Steel Structures: Standard & Built up Sections, Various Types of Joints, Bolted & Welded Connections for Components & Brackets (Lap, Butt, Lozenzo's, Concentric & Eccentric Joints) Shear, Moment & Both Shear-Moment Types. 	15%
Chapter-2	<ul style="list-style-type: none"> ➤ Make technically precise drawings and write outline specification for column foundation, beams, roof, portal frame & connections therein, in steel. 	Steel grillage & cement concrete foundation: Steel grillage and pedestal foundation for steel columns.	<ul style="list-style-type: none"> ➤ Foundation & Bearing Units for Steel Structures: ➤ For Columns – Flexible & Rigid, Slab based, Gusset based, Rocker Bearing & Roller Bearing. ➤ For Beams – Pin / Hinged / Fixed / Rocker & Roller. 	10%
Chapter-3		Steel member splicing and connections: Column to column, beam to column, beam to beam	<ul style="list-style-type: none"> ➤ Splicing for Steel Members: Columns, Beams & Frames. Different Types with Joinery. 	Nil
Unit-II				

 FORM ISO 9001: 2008-KLETU School of Architecture	Document #: FMCD2005	Rev: 1.0
		Page 21 of 28
		Year:2021-22

Chapter-4		Steel Beams and Girders Standard section, castellated beam, plate girder, lattice girder, vierendel girders	➤ Flextural Components for Steel Structures: Purlins, Beams, Girders, Castellated Beam, Vierendeel Girder & Lattice Girder. Joinery, Components & Erection.	15%
Chapter-5		Steel roof trusses Various types of steel trusses for small, medium, large span trusses. North light roof truss	➤ Roofing System for Steel Structures: Types, Forms & Components like Girders, Trusses, Purlins Braces, Eaves, Storm Water Drains, Ridge, Hip, Valley & Roofing Materials.	20%
Chapter-6		Steel portal frame and PEB. Concept of PEB. Various components used in PEB. Application criteria	➤ Framed Steel Structures: Portal Frames, Concept of Pre-Engineered Buildings. Types of Frames, Components & Spans.	10%
Unit-III				
Chapter-7		Weather proofing materials Building components that requires weather proofing. Materials & method of application as pre and post treatment.	➤ Composite Constructions: Concepts, Different types of the Composite Constructions, Sketches showing details & Construction Methods.	100%
Chapter-8		Ferrous and non-ferrous metals Properties & architectural application of C.I., W.I., M.S.,S.S., H.T.S., copper, brass, bronze, lead, aluminium etc	➤ Protection of Ferrous & Non Ferrous Metals: Pre & Post Treatments, Anti Corrosive Paints, Powder Coating & Anodising.	Nil

Chapter No.'s	Existing Evaluation Methods	Proposed Evaluation Methods	Mode of Assignments
Unit-I			

	FORM ISO 9001: 2008-KLETU School of Architecture	Document #: FMCD2005	Rev: 1.0
	Title: Curriculum Content- Course wise		Page 22 of 28 Year:2021-22

Chapter-1	Submissions / Assignments	Submissions (30%) / Assignments (20%) / Examinations (50%).	Submissions / Assignments / Examinations
Chapter-2	Submissions / Assignments	Submissions (30%) / Assignments (20%) / Examinations (50%).	Submissions / Assignments / Examinations
Chapter-3	Submissions / Assignments	Submissions (30%) / Assignments (20%) / Examinations (50%).	Submissions / Assignments / Examinations
Unit-II			
Chapter-4	Submissions / Assignments	Submissions (30%) / Assignments (20%) / Examinations (50%).	Submissions / Assignments / Examinations
Chapter-5	Submissions / Assignments	Submissions (30%) / Assignments (20%) / Examinations (50%).	Submissions / Assignments / Examinations
Chapter-6	Submissions / Assignments	Submissions (30%) / Assignments (20%) / Examinations (50%).	Submissions / Assignments / Examinations
Unit-III			
Chapter-7	Submissions / Assignments	Submissions (30%) / Assignments (20%) / Examinations (50%).	Submissions / Assignments / Examinations
Chapter-8	Submissions / Assignments	Submissions (30%) / Assignments (20%) / Examinations (50%).	Submissions / Assignments / Examinations

Teaching / Learning Methodology	Course Outcomes			
	1	2	3	4
Lectures / Tutorials	Yes	Yes	Yes	Yes
Assignments	Yes	Yes	Yes	Yes
3d Models / Projects	Yes	Yes	Yes	Yes

Program: Architecture		
Course Title: Architectural Design VI (Housing)		Course Code: 18AATC308
L-T-P : 0 -6-0	Credits:6	Contact Hours:9 Hrs
ISA Marks: 50	ESA Marks: 50	Total Marks: 100
Teaching Hours: 126 Hrs	Examination Duration: 60min	

Course contents:

Housing Studio aligns with state and national policy for housing for all, which is inclusive in nature. Mass housing, Issues related to housing shortages, incremental housing, sites and service schemes, slums and squatter settlements. Design in a climate responsive and environment friendly way while planning medium sized housing complexes. Apply the appropriate technology for Low cost housing, self-help housing, Co-operative housing, Housing based on income groups, density patterns and arrangement of units, temporary housing for disaster mitigation, rehabilitation housing, slum upgradation.

Studio project can also make decisions towards low-rise high-density housing or high-rise high density housing project. While designing socio-economic determinants, regulatory and technological alternatives shall be studied in detail. Exercises in simulation and conceptual modeling shall be conducted. Application of concepts of project phasing, financing and construction planning are to be applied in low-rise high-density housing or high-rise high

 KLE TECH	FORM ISO 9001: 2008-KLETU School of Architecture	Document #: FMCD2005	Rev: 1.0
Title: Curriculum Content- Course wise			Page 23 of 28 Year:2021-22

density housing. The design shall be sensitive to the needs of disabled, aged people and children

The students are expected to carry out detailed site analysis, documenting physical features, vegetation, land forms soil characteristics, slope analysis and natural drainage patterns. Site planning exercise should depict understanding of vehicular and pedestrian movement patterns, land grading and conservation of ecologically sensitive features.

They are also expected to be conscious about the need for energy conservation through passive design. They will apply advanced simulation and modeling techniques to orient their buildings and decide energy performance parameters. Sample quantity estimates and specifications are to be prepared.

Housing projects can be attempted with added complexities for example, dense context, occupation based, traditional urban fabric, social status and prevalent social strata. Details from the dwelling cell to immediate shared space to communal space shall be emphasized and worked out. Socio cultural layer of the occupants shall form a strong fabric in the ultimate weave of the design. Projects shall aim at developing a sensitive attitude towards micro level human habitation and role of architecture in enhancing or curbing the quality of living.

Unit I

Design Analysis :

Research of the given design project, Analysis of precedents.

Site analysis / Concept Development:

Site plan, Site analysis, site synthesis and zoning,
 Formulation of design brief ,conceptual sketches,
 Design development.

Preliminary Design Development stage:

Schematic drawings of Master Plan
 sections , elevations and study models

Unit II

Design of Prototype to ensure interrelationship between the building codes, efficiency metrics, urban design issues and architectural approaches.

Development of detail plans, elevations and sectional details, Models, Development of Three dimensional massing with corresponding fenestrations, details of services and structural system. Detailing of Public/open spaces and amenities.

UNIT III: Finalization of design:

Report and portfolio in computer aided Architectural Presentation and rendered drawings

Text Books

Reference Books:

1. Brooks, R. G. (1988). Site Planning: Environment, Process and Development. Michigan.
2. Clapham, D., Clark, W. A. V. and Gibbs, K. (2012). The Sage Handbook of Housing Studies. London : Sage Publications.
3. Correa, C. (2010). A Place in the Shade: The New Landscape and Other Essays. New Delhi : Penguin Books.
4. Ferre, A. and Tihamer, S. H. (2010). Total Housing: Alternatives to Urban Sprawl. New York : ACTAR Publishers.
5. Greater London Council. (1978). An Introduction to Housing Layout: A GLC Study. London.
6. Lee, K. E. (1984). Time Saver Standards for Site Planning. McGraw-Hill Ryerson.
7. Levitt, D. and Levitt, B. (2010). The Housing Design Handbook. New York : Routledge.
8. Root, B. J. (1985). Fundamentals of landscaping and site planning. AVI Publications.
9. Untermann, R. and Small, R. (1977). Site Planning for Cluster Housing. Van Nostrand Reinhold
10. HUDCO publications: Housing for Low income, Sector Model.
11. "Saxena A.K., Sociological Dimensions of Urban Housing and Development" Wealth publications. 2004
12. Leuris S, Front to Back: "A design Agenda for Urban Housing", Architectural Press, 2006.
13. Richard Kintermann and Robert Small, "Site Planning for Cluster Housing", Van Nastrand Reinhold company, Jondon/ New York 1977.

 <small>KLE TECH</small>	<p style="text-align: center;">FORM</p> <p style="text-align: center;">ISO 9001: 2008-KLETU</p> <p style="text-align: center;">School of Architecture</p>	<p style="text-align: center;">Document #: FMCD2005</p>	<p style="text-align: center;">Rev: 1.0</p>
<p style="text-align: center;">Title: Curriculum Content- Course wise</p>			<p style="text-align: center;">Page 24 of 28</p> <p style="text-align: center;">Year:2021-22</p>

Scheme for Semester End Examination (ESA)

Evaluation of Portfolio, assignments by internal and external examiners

The students have to present the entire semester work for assessment along with Models. A viva-voce (Approximate 15 minutes /student) shall be conducted by a jury comprising of an external examiner and an internal examiner.

	FORM ISO 9001: 2008-KLETU School of Architecture	Document #: FMCD2005	Rev: 1.0
	Title: Curriculum Content- Course wise		Page 25 of 28 Year:2021-22

Program : Architecture		
Course Title: BUILDING CONSTRUCTION & MATERIALS - VI		Course Code: 18AATC309
L-S-P: 0-4-0	Credits: 4	Contact Hours: 6 Hrs
ISA Marks: 50	ESA Marks: 50	Total Marks: 100
Teaching Hours: 84 Hrs	Examination Duration: NA	
UNIT I: <p>a) Ferrous & Non Ferrous Metals: Types, Properties & Application in Architecture. CI, MS & WI, Different Steels, Alloys (Brass & Bronze). (Sheet – 1no.)</p> <p>b) Steel Structures: Standard & Built up Sections, Various Types of Joints & Brackets (Lap, Butt, Lozenzo’s, Concentric & Eccentric Joints) Shear, Moment & both Shear-Moment Types. Bolted & Welded Connections for Components. (Sheet – 2 nos.)</p> <p>c) Foundation & Bearing Units for Steel Structures: For Columns – Flexible & Rigid, Slab based, Gusset based, Rocker Bearing & Roller Bearing. For Beams – For Columns, Beams, Frames. Pin / Hinged / Fixed / Rocker & Roller. (Sheet – 1no.)</p> <p>d) Splicing for Steel Members: Columns / Beams / Frames. Different Types with Joinery. (Sheet – 1no.)</p>		
UNIT II: <p>a) Flextural Components for Steel Structures: Purlins, Beams, Girders, Castellated Beam, Vierendeel Girder & Lattice Girder. Joinery Components & Erection. (Sheet – 2no.)</p> <p>b) Roofing System for Steel Structures: Types, Forms & Components like Girders, Trusses, Purlins Braces, Eaves, Storm Water Drains, Ridge, Hip, Valley & Roofing Materials.(Sheet – 2no.)</p> <p>c) Protection of Ferrous & Non Ferrous Metals: Pre & Post Treatments, Anti Corrosive Paints. Powder Coating & Anodising. (Sheet – 1no.)</p>		
UNIT III: <p>a) Framed & Steel Structures: Portal Frames, Concept of Pre-Engineered Buildings. Types of Frames / Components / Spans. (Sheet – 2nos.)</p>		
Note – The Portfolio covering the above topics shall be presented for Term work. Site visits shall be arranged by studio teacher. Study of material application shall be submitted in the form notes, sketches and photo brief as a part of portfolio		
Text Books: <ul style="list-style-type: none"> • McKay J.K Building Construction Metric Vol 1-4, 4thedi Orient Longman Pvt. Ltd, Mumbai,2002 • “Construction Technology” volume-I by R Chudley, ELBS & Longman group Ltd. • Barry R, “The construction of buildings” , Vol-2, 5th Edi, East West Press, New Delhi 1999. • Bindra S.P and Arora S.P, Building Construction-Planning Techniques and Method of Construction, 19thedi, Dhanpat Rai Pub ,NewDelhi, 2000 		

 <small>KLE TECH</small>	FORM ISO 9001: 2008-KLETU School of Architecture	Document #: FMCD2005	Rev: 1.0
Title: Curriculum Content- Course wise			Page 26 of 28 Year:2021-22

- “Building Construction” by JanardhanJha, Khanna New-Delhi.
- Rangawal S.C ,“Building Construction” 22nd Edi, charotar Publishing house, Anand, 2004
- “Engineering Materials” by Surendra Singh, Vikas Delhi.
- “Building Materials” by S K Duggal, IBH New Delhi.
- Sushil Kumar T.B of Building Construction 19thedi, Standard Pub House, NewDelhi, 2003.
- Chowdhary K.P. Engineering Materials used in India, 7th Edi, Oxford and IBH Pub ltd New Delhi, 1990.
- Building Construction Hand book: By R Chudly& R Greeno, Bullerworth Heinemann, New-Delhi.

Scheme for internal Assessment (ISA): Evaluation of term work regularly and tests conducted

Scheme for Semester End Examination (ESA): Evaluation of term work portfolio & Viva

	FORM ISO 9001: 2008-KLETU School of Architecture	Document #: FMCD2005	Rev: 1.0
	Title: Curriculum Content- Course wise		Page 27 of 28 Year:2021-22

Program: Architecture		
Course Title: SERVICES – IV(Acoustic)		Course Code: 18AATC310
L-T-P : 2 – 0 - 0	Credits: 2	Contact Hours: 2Hrs
ISA Marks: 50	ESA Marks: 50	Total Marks: 100
Teaching Hours: 28 Hrs	Examination Duration: 3 Hours	
Unit I Introduction and Scope of Acoustics: <ol style="list-style-type: none"> Nature and properties of sound, Physics of sound – Sound propagation basic terminologies – frequency, pitch tone, sound pressure, sound intensity, decibel scale, loudness, threshold of audibility & plain, masking, sound distance- inverse square law. Acoustics in built environment - Behavior of sound in enclosed spaces, Reflection of sound, Nature of Reflection from plane, Convex & concave surfaces, sound diffraction, Echoes, Whispering galleries, Dead spots & sound foci. Reverberation, reverberation time, use of Sabine’s formulae and its interpretation. Sound field of classrooms, offices & studios. Auditorium acoustics – Design criteria. Noise Control – Classification of Noise, Environmental impact of noise & acceptable noise levels. Principles Of noise control – noise sources, airborne & structure borne sound. Vibration isolation – Damping of noise, noise barriers, noise transmission through ducts, Design criteria for Industrial noise control, planning considerations, use of unit absorbers, treatment of floor & wall. 		
Unit II Study of Acoustical Materials – <ol style="list-style-type: none"> Sound Absorbers (Acoustical Foam, White Printable Acoustical Panel, Fabric wrapped panels, Wall Acoustical Coverings, Ceiling Tile, and Baffles & Banners). Sound Diffusers such as (Quadra Pyramids diffusers, Pyramid Diffuser, Double duty Diffusers, Quadric Diffuser) etc. Absorption coefficient of Indigenous acoustical materials method of setting out of raked seating. Applications of noise control - Sound proof doors and windows, sound leaks in doors and windows, floating floors, cavity wall construction, discontinuous joints, noise reduction between rooms and floors, resilient hangers. 		
Unit III Study and development of ---Auditorium and theaters Brief about – History of Greek & Roman style theatres, open air theatre concept. <ol style="list-style-type: none"> Design details of---- audio visual room, Seminar hall, Cinema Theater, auditorium with balcony used for drama, music and speech. Lecture halls, office building <p>Case study of an auditorium acoustically treated with drawings---acoustical design for any one type of building with RT calculations.</p> <p>Objective: To acquaint the student with the general guiding principles and procedures on which Acoustical Designing is based and applications of such principles in Architectural cases.</p>		

 FORM ISO 9001: 2008-KLETU School of Architecture	Document #: FMCD2005	Rev: 1.0
		Page 28 of 28
		Year:2021-22

Text Books

Reference Books:

1. "Architectural Acoustics Principles and Design "By David R. Johnson and Madan L. Mehta.
2. "Auditorium Acoustics and Architectural Design" By Michael Barron.
3. "McDavid Egan (1988)-Architectural Acoustics" McGraw hill book co., NY.
4. Parich, Peter (1979) Acoustics: Noise and Buildings, Faber and Faber, London
5. Acoustics and Noise Control: B.J. Smith, R.J. Peters, S owen, Longman Group Ltd. U.S.A., 1982
6. Acoustical Designing in architecture: Vern o. Knudsen and Cyril M. Harris, John Wiley & Sons, inc. London. 1963
7. Master Hand book of Acoustics: F.Alton Everest, 4ed, McGraw-Hill, Two Penn Plaza, New York, NY 10121-2298 (Delhi- India), 1945
8. Acoustics Noise and buildings: P.H. Parkin, H.R. Humphreys and J.R Cowell, 4ed, Ebenezer Balis and Son, Ltd., the Trinity Press, Worcester, and London, 1979
9. Acousics : R. L. Suri, 1ed, Asia Publishing, Mumbai, 1966

Scheme for Semester End Examination (ESA)

UNIT	8 Questions to be set of 20 Marks Each	Chapter numbers	Instructions
I	Question Numbers 1, 2 & 3	I	Solve Any 2 out of 3
II	Question Numbers 4, 5 & 6	II	Solve Any 2 out of 3
III	Assignment	III	Design application Solve 1 OUT OF 1

	FORM ISO 9001: 2008-KLETU School of Architecture	Document #: FMCD2005	Rev: 1.0
	Title: Curriculum Content- Course wise		Page 29 of 28 Year:2021-22

Program : Architecture		
Course Title: Contemporary Architecture		Course Code: 18AATC311
L-S-P: 2-0-0	Credits: 02	Contact Hours: 2 Hrs
ISA Marks:50	ESA Marks: 50	Total Marks: 100
Teaching Hours: 28 Hrs	Examination Duration: 3 HOURS	
UNIT I: <ul style="list-style-type: none"> • Ideas and works of late modernism architect's i.e Richard Meier etc, • Ideas and Works of postmodern architect's i.e., Charles Moore etc • Ideas and Works of De-construction architect's i.e Frank Gehry etc 		
UNIT II: <ul style="list-style-type: none"> • Contemporary western architecture – • Ideas and Works of hi-tec architecture i.e. Works Norman Foster, Renzo Piano, Richard Rogers, etc. • Ideas and Works of artist and architects i.e. Santiago Calatrava etc 		
UNIT III: <ul style="list-style-type: none"> • Contemporary Indian architecture ninety onwards. 		
NOTE: The architects and ideas mentioned above are indicative only The course teacher may choose the ideas and works of architects to explain with examples		
Text Books: Nil		
Reference Books: <ol style="list-style-type: none"> 1. Bahga, Bahga and Bahga, Modern Architecture in India 2. Jon Lang, A Concise History of Modern Architecture in India 3. Charles Jencks, Current Architecture 4. Dennis Sharp, 20th Century Architecture, A Visual History 5. James Steel, Architecture Toda 		

Internal Semester Assessment (ISA) - 2 Minor test and assignments
Scheme for Semester End Examination (ESA)

Sl.No	8 Questions to be set of 20 Marks Each	Unit Number	Instructions
1	Question Numbers 1, 2 & 3	I	Solve Any 2 out of 3
2	Question Numbers 3, 5 & 6	II	Solve Any 2 out of 3
3	Question Numbers 7 & 8	III	Solve Any 1 out of 2

 FORM ISO 9001: 2008-KLETU School of Architecture	Document #: FMCD2005	Rev: 1.0
		Page 30 of 28
		Year:2021-22

Program: VI Semester B. Arch		
Course Title: Settlement Planning		Course Code: 18AATC312
L-S-P: 2-0-0	Credits: 2	Contact Hours: 2 hrs
ISA Marks:50	ESA Marks:50	Total Marks: 100
Teaching Hours: 28 hrs	Examination Duration: 3 hrs	
Unit I 1. INTRODUCTION TO HUMAN SETTLEMENTS Elements of Human Settlements, their functions and Linkages – Anatomy & classification of Human settlements Historical development of a City as a product of socio-cultural, economical and political ideologies, Urban settlements and rural settlements: Origins, evolution and growth of settlements, characteristics, relation and differences. Principles of settlement planning in various historical periods like Mesopotamian, Egyptian, Greek, Roman, Medieval, Renaissance and Neo-classical, Cities of Vedic period, Indo- Aryan cities, Indus valley, typical Dravidian temple city. Cities of Mughal period and British-Colonial period. 2. PLANNING CONCEPTS: Role and contribution of the following towards contemporary town planning thought: Geddesian Triad and outlook Tower by Patrick Geddes, City Beautiful by Daniel Burnham, Garden city by Ebenezer Howard, Neighbourhood by C.A.Perry, Radburn by Henry Wright and Clarence Stein, Ekistics by CA Doxiadis, City for three million habitat, Radiant city and Chandigarh by Le Corbusier and F.L.Wright, Soria Y Mata, Kevin Lynch, Ian Mcharg and Jane Jacobs.		
Unit II 3. CONTEMPORARY ISSUES IN URBAN PLANNING: Contemporary problems of settlements, Environmental impact of unplanned growth. Socio-economic aspects of urban housing and problems of slums NHP, rationale of urban regulatory controls. Urban redevelopment and renewal, urban traffic and transportation planning, URDPFI, JNNURM, PMAY 4. URBAN AND REGIONAL PLANNING Influence of socio-economic factors in the development of human settlements, growth and decay of human settlements. Classification of settlements: Classification based on population, functions, locations, Municipal status. Town and its land uses, graphical representation and colour coding of land use, character of a town, categories of a town, densities of a town, Principles, Advantages and types of Zoning. Scope and purpose of Perspective Plan, Regional Plan, Development Plan, Local Area Plan, Special Purpose Plan, Annual Plan, Project, and Concept of Participatory approach in planning process. Introduction to Urban Design, Basic Definitions and Terminology, elements, principles, Concept of public and private realm		
Unit III 5. TOWN PLANNING TECHNIQUES Data Collection Techniques, Types of Surveys, Data and Map Analytical Techniques, Applying Carrying Capacity for Urban and Regional planning, Threshold Analysis – Factors taken into consideration to assess the most suitable land use & weighted overlay of Land suitability, Projection Techniques - Population Projection and Economic Projection, Plan formulation through Remote Sensing & Geographic Information System, Central business district, other business districts, urban nodes, rest of the city, fringe area and suburbs 6. EMERGING TRENDS IN URBAN PLANNING Globalization and its impact on cities: Self Sustained Communities, Special Economic Zones (SEZ), Transit Oriented Development (TOD) and Integrated townships, New Urbanism, Smart growth, Transect Future of cities and cities of future - Sustainable cities, Intelligent cities, Livable cities, Resilient cities, Smart Cities, Global city, Eco city, Compact city, Vertical urbanism, MediCity, Sports city		
Scheme for Internal semester assessment (ISA)		

	FORM ISO 9001: 2008-KLETU School of Architecture	Document #: FMCD2005	Rev: 1.0
	Title: Curriculum Content- Course wise		Page 31 of 28 Year:2021-22

Term work: Evaluation of Portfolio, assignments by internal examiner, theory exam

Scheme for End Semester Assessment (ESA)

External examination-3 hrs

Mode of assessment :

Portfolio & Theory exam.

Text Books:

Reference Books:

1. Chapin III F. Stuart, Kaiser Edward J. and Godschalk David R., Urban Land Use Planning, University of Illinois Press, Illinois, 1995 and onwards.
2. Dutt, Binode Behari, Town Planning in Ancient India, Gyan Books Pvt. Ltd., Delhi, 2009
3. Gallion Arthur and Eisner, The Urban Pattern: City Planning and Design, CBS Publisher, New Delhi, 2005 and onwards.
4. Lynch Kevin, The Image of the City, Harvard University Press, Harvard, 1960 and onwards.
5. Correa Charles, Housing and Urbanization, Thames & Hudson, London, 2000
6. Rossi Aldo, The Architecture of the City, The MIT Press, New York, 1984 and onwards.
7. Keeble Lewis, Principles and Practice of Town and Country Planning, The Estates Gazette Ltd., London, 1969
8. Gordon Cullen Thomas, The Concise Townscape, Architectural Press Routledge, 1961 and onwards
9. Hough Michael, Cities and Natural process: A Basis for Sustainability, Routledge, 1995 and onwards

Scheme for Semester End Examination (ESA)

UNIT	8 Questions to be set of 20 Marks Each	Chapter numbers	Instructions
I	Q.No.-1, Q.No.-2, Q.No.-3	I	Solve Any 2 out of 3
II	Q.No.-4, Q.No. – 5 Q.No.-6,	II	Solve Any 2 out of 3
III	Q.No.-7, Q.No.-8	III	Solve Any 1 out of 2

	FORM ISO 9001: 2008-KLETU School of Architecture	Document #: FMCD2005	Rev: 1.0
	Title: Curriculum Content- Course wise		Page 32 of 28 Year:2021-22

Program : Architecture		
Course Title: Interior Design		Course Code: 18AATC313
L-S-P: 0-2-0	Credits: 2	Contact Hours: 3 Hrs
ISA Marks: 50	ESA Marks: 50	Total Marks: 100
Teaching Hours: 42 Hrs	Examination Duration: NA	
UNIT I: Introduction to Interior Architectural Design Definition of interior design, Interior architectural design process, vocabulary of design in terms of principles and elements, Introduction to the design of interior spaces as related to typologies and functions, themes and concepts - Study and design. History of Interior Architectural Design Brief study of the history of interior architectural design through the ages relating to historical context, design movements and ideas etc. Brief study of folk arts and crafts. (vernacular design in India) with reference to interior design and decoration.		
UNIT II: Elements of Interior Architecture - Enclosing Elements Introduction to various elements of interiors like floors, ceilings, walls, staircases, openings, interior service elements, incidental elements etc., and various methods of their treatment involving use of materials and methods of construction in order to obtain certain specific functional, aesthetic and psychological effects. Elements of Interior Architecture – lighting accessories & interior landscaping Study of interior lighting, different types of lighting their effects types of lighting fixtures. Other elements of interiors like accessories used for enhancement of interiors, paintings, objects-de-art, etc. Interior landscaping, elements like rocks, plants, water, flowers, fountains, paving, artifacts, etc. their physical properties, effects on spaces and design values		
UNIT III: Elements of Interior Architecture - Space Programming Study of the relationship between furniture and spaces, human movements & furniture design as related to human comfort. Function, materials and methods of construction, changing trends and lifestyles, innovations and design ideas. Study on furniture for specific types of interiors like office furniture, children's furniture, residential furniture, display systems, etc. Design Projects on Residential, Commercial and Office Interiors. Quantity survey and costing of Interior materials and elements Study of the basic quantifying and estimation of the interior design items. Market study investigating the material manufacturers, usage, standards available, and thumb rule based costing and quantity calculation for an interior design project.		
Scheme for Internal semester assessment (ISA) The Portfolio covering the given topics and the study models shall be presented. The evaluation shall be through periodic internal reviews and assignments. The students have to present the entire semester work for assessment along with Models. Term work Evaluation of Portfolio, assignments by internal examiner		
Scheme for End Semester Assessment (ESA) Term work: Evaluation of Portfolio and assignments by internal and external examiners/Viva		

	FORM ISO 9001: 2008-KLETU School of Architecture	Document #: FMCD2005	Rev: 1.0
	Title: Curriculum Content- Course wise		Page 33 of 28 Year:2021-22

Mode of assessment : Portfolio, Models, Assignment, Presentation, Reviews

Text Books –

1. John Hancock, Time Saver Standards for Architectural Data.
2. Ramsay and Sleeper, Architectural Graphic Standards
3. Alexander and Mercourt , Design of Interior Environment
4. Panero Julious and Zelink Martin, Human Dimension and Interior Space

Reference Books:

1. Ching, F. D. K. (1987). Interior Design Illustrated. New York : V.N.R. Publications.
2. Doshi, S. (Ed.) (1982). The Impulse to adorn - Studies in traditional Indian Architecture. MargPublications.
3. Kathryn, B. H. and Marcus, G. H. (1993). Landmarks of twentieth Century Design. Abbey VillePress.
4. Penero, J. and Zelnik, M. (1979). Human Dimension and Interior space: A Source Book of Design Reference Standards. New York : Whitney Library ofDesign.
5. Slesin, S. and Ceiff, S. (1990). Indian Style. New York : Clarkson N.Potter.
6. Dorothy, S-D., Kness, D. M., Logan, K. C. and Laura, S. (1983). Introduction to Interior Design. Michigan : Macmillan Publishing.

Scheme for internal Assessment (ISA) : Evaluation of term work regularly andReviews

Scheme for Semester End Examination (ESA) : Evaluation of term work portfolio & Viva

 FORM ISO 9001: 2008-KLETU School of Architecture	Document #: FMCD2005	Rev: 1.0
		Page 34 of 28
		Year:2021-22

Program : Architecture		
Course Title: STRUCTURES - VI		Course Code: 18AATC313
L-S-P: 3-0-0	Credits: 3	Contact Hours: 3
ISA Marks: 50	ESA Marks: 50	Total Marks: 100
Teaching Hours: 42	Examination Duration: 3 HOURS	
UNIT I: 1. Vertical/lateral structural systems: introduction. Structural design project of a 15 story of 40m X 40m X 32m. Calculation dead load, live load and wind load as per IS 875-1984. 2. Seismic loading calculation as per IS1983-2002 part - I. 3. Introduction to lateral load resisting system, shear wall system and dual system.		
UNIT II: 4. Introduction to earthquake resistant system, and effect of an earthquake as a whole on society. Elementary seismology, plate tectonic theory, magnitude and intensity of earthquake and seismic zonal map of India. 5. Earthquake loads on a simple building, vertical load distribution of base shear. Design philosophy of earthquake resistant structures.		
UNIT III: 1. Seismic behavior of load bearing structures, in plane and out of plane walls and stiffeners. Shear walls, moment resisting frames and braced frames 2. plan configuration, vertical configuration and infill walls		
Text Books: 1. Dr. Ram Chandra, Design of Steel Structures, Vol I, 10 th ed. Standard book house, New Delhi, 1999. 2. S. Ramambrutham and R Narayanan, Design of Steel Structures, 4 th ed. Dhanpat Rai and Sons, Delhi 1995		
Reference Books: 1. Structures Martin Bechthold, Daniel L Schodek. PHI Learning pvt. Ltd		

Internal Semester Assessment (ISA) 2 Minor test and assignments

Scheme for Semester End Examination (ESA)

Sl.No	8 Questions to be set of 20 Marks Each	Unit Number	Instructions
I	Q.No.-1, Q.No.-2, Q.No.-3	I	Solve Any 2 out of 3
II	Q.No.-4, Q.No. – 5 Q.No.-6,	II	Solve Any 2 out of 3
III	Q.No.-7, Q.No.-8	III	Solve Any 1 out of 2

 FORM ISO 9001: 2008-KLETU School of Architecture	Document #: FMCD2005	Rev: 1.0
		Page 35 of 28
		Year:2021-22

Program : Architecture		
Course Title: Analyzing Architecture		Course Code: 18AATE308
L-S-P: 0-2-0	Credits: 01	Contact Hours: 02
ISA Marks: 50	ESA Marks: 50	Total Marks: 100
Teaching Hours: 28	Examination Duration: NA	
Course contents: Unit-I: Architecture as identification of place, basic elements and modifying the elements. Unit-II: Architecture as doing more than one thing, using things that are there and using primitive place types. Unit-III: Architecture as making frames and establishing the relationship of space to structure.		
Sessional Work (Internal semester assessment) Evaluation of assignments in three stages		
Scheme for Semester End Assessment (ESA) Evaluation of assignments		
Mode of assessment : Evaluation of Portfolio, assignments by internal and external examiners		
References : Architectural design books, periodicals & websites		

	FORM ISO 9001: 2015- KLE TECH School of Architecture	Document #: FMCD2005	Rev: 1.1
Curriculum Content- Course wise		1 Page of 27	Year: 2021 - 22

VII Semester – VIII Semester

Program Head

Signature of Dean (Academic Affairs)

	FORM ISO 9001: 2015- KLE TECH School of Architecture	Document #: FMCD2005	Rev: 1.1
			Year: 2021 - 22

Semester: VII(2018-19)

Sr.No	Course code	Course Title	Period			Evaluation scheme			Credit (L+T+P)	Hours
			L	T	P	ISA	ESA	Sub total		
1	18AATC401	Architectural Design VII (Campus Planning)	0	7	0	50	50	100	7	10
2	18AATC402	Building Construction and Materials	1	3	0	50	50	100	4	6
3	18AATC403	Dissertation	0	3	0	50	50	100	3	4
4	18AATC404	Structure-VII	0	3	0	50	50	100	3	4
5	18AATC405	Professional Practice 1	3	0	0	50	50	100	3	3
6	18AATC406	Online Portfolio	0	1	0	50	50	100	1	2
7	18AATC407	Elective-III	0	0	1	50	50	100	1	2
TOTAL			7	14	1	350	350	700	22	31

ISA: In-semester Assessment **ESA:** End Semester Assessment **L:** Lecture **T:** Tutorials **P:** Practical

Credit	Lecture Hours	Studio Hours	Practical Hours
1	1	1.5	2

Program Head

Signature of Dean (Academic Affairs)



FORM
ISO 9001: 2015- KLE TECH
School of Architecture

**Document
#:
FMCD2005**

Rev: 1.1

Curriculum Content- Course wise

3|Page of 27

Year: 2021 - 22

	FORM ISO 9001: 2015- KLE TECH School of Architecture	Document #: FMCD2005	Rev: 1.1
Curriculum Content- Course wise			4 Page of 27
			Year: 2021 - 22

Program : Architecture		
Course Title: Architectural Design VII (Campus Planning)	Course Code: 18AATC407	
L-S-P: 0-7-0	Credits: 7	Contact Hours: 10
ISA Marks: 50	ESA Marks: 50	Total Marks: 100
Teaching Hours: 140	Examination Duration: NA	

Course content: the following issues relating to institutional design will be addressed to:

- Nature of contemporary institution, correlation to urban structure.
- Development control and urban infrastructure affecting design.
- Various attitudes to building in urban context.
- Integration to function and movement, climate, and sound, structure and services into group of buildings
- Landscaping and site planning.
- Institutional character – from abstract to detail.
- User behavior and requirements pertaining to the physically handicapped.

Necessary theoretical inputs to be given highlighting the norms and design issues The topics not covered as studio faculty members through lecture/slide shows and site visits may cover design problems.

The topics to be covered as design problems may include:

- Institution of learning – colleges with it's various departments such as medical, engineering, law, business, music, and dance colleges, vocational training institutes etc.
- Institutions of life such as hospitals, reformatories and rehabilitation institutes for the disabled.
- Institutions of research in various disciplines.
- Local/legal institutions such as the high courts, secretariat, development authorities, directorates etc.

At least two major exercises and two minor design / time problems should be given .the final submission shall necessarily include a model for at least one of the two main problems.

 KLE TECH.	FORM ISO 9001: 2015- KLE TECH School of Architecture	Document #: FMCD2005	Rev: 1.1
Curriculum Content- Course wise		5 Page of 27	
		Year: 2021 - 22	

The students have to present the entire semester work for assessment along with Model.

Sessional Work (Internal semester assessment)

The 'Sessional Work' shall comprise of the following.

- (i) A hand written journal with notes and manual sketches of representative examples (10 marks)
- (ii) A graphically presented or a written report with illustration of Any One of the topics to be individually elected and completed under the periodic supervision and guidance of the subject teacher. (20 marks)
 - (a) Scaled manual documentation of field studies of precincts, streets, building or parts thereof and artifacts bearing significance to the periodic history under study (not more than two half imperial sized sheets A2 – 420 x 594 mm each)
OR
 - (b) Graphically illustrated and annotated manual presentation on 'Style identification' of Building or parts thereof bearing significance to periodic history under study (Not more than two half imperial sized sheets (42 – 420 x 594 mm each).
OR
 - (c) A hand written illustrated report of not more than 1000 words on comparative study of architectural features, motifs, design themes and typological planning Evolutions in the periodic history under study. (20 marks)

Scheme for Semester End Assessment (ESA)

Mode of assessment :

References :

- 1 Campus design in India – Kanvinde & Miller
2. Campus Planning _ Richard Dober.
3. Urban Design. The Architecture of towns and cities. –Paul Spreirengen.
4. Exterior design in Architecture __ Ashihara Toshinibu
5. Modern Language of Architecture __ Bruno Zevi.
6. Modern Movements in Architecture __ Charles Jencks
7. Language of Post – modern Architecture - Charles Jencks
8. Complexities and contradictions in Architecture – Robert Venturi
9. Architectural Composition. –Rob Krier.
10. Pattern Language Christopher Alexander.
11. Town Design –Fredrick Gibberd Alexander
12. Various monographs and periodicals

	FORM ISO 9001: 2015- KLE TECH School of Architecture	Document #: FMCD2005	Rev: 1.1
Curriculum Content- Course wise		6 Page of 27	
		Year: 2021 - 22	

Program : Architecture		
Course Title: Building Constructions & Materials- VII		Course Code: 18AATC402
L-S-P: 0-4-0	Credits: 4	Contact Hours: 6
ISA Marks: 50	ESA Marks: 50	Total Marks: 100
Teaching Hours: 84Hrs	Examination Duration: NA	
<p>Course contents:</p> <p>Unit-I: Large span Roofing systems, shell roof, Folded Plates in R.c.c, advantages over conventional roofing systems and details there in space frame, Tensile & Pneumatic structures, evolution, advantages, scope and construction details there in.</p> <p>Unit-II: Envelop system Method of using various types of curtain wall method including structural glazing Advantages, provision and arrangements made during construction, working out details with various metals.</p> <p>Unit-III: Pre fab, Pre stress and post tension study of various buildings prefab elements, advantages over in situ components study of pre tensioning and post tensioning of prefab and in situ components</p> <p>Advantages & disadvantages over regular reinforcement, pre & post tensioning method.</p> <p>Material-</p> <p>Concrete admixture adhesive & sealants, pest control Identifying the pest which may attack the buildings precautionary measures taken during construction. Pre & post treatment methods</p>		
<p>Sessional Work (Internal semester assessment)</p> <p>The 'Sessional Work' shall comprise of the following.</p>		
<p>Scheme for Semester End Assessment (ESA)</p> <p>The students have to present the entire semester work for assessment along with Model.</p>		
<p>Mode of assessment :</p> <p>A1 size sheets related to above mentioned topics</p> <p>Models to scale on each topic are expected</p>		
<p>References :</p>		

	FORM ISO 9001: 2015- KLE TECH School of Architecture	Document #: FMCD2005	Rev: 1.1
	Curriculum Content- Course wise		7 Page of 27 Year: 2021 - 22

Program : Architecture		
Course Title: Dissertation		Course Code: 18AATC403
L-S-P: 0-3-0	Credits: 3	Contact Hours: 4
ISA Marks: 50	ESA Marks: 50	Total Marks: 100
Teaching Hours: 42	Examination Duration: NA	
<p>Course contents: The objective of this course is to orient the students to gain a strong theoretical analytical base for a well structured research. The course shall enable students to conduct research, analyse and write a research paper on a topic of their interest.</p> <p>Students may choose a topic related to Architecture and allied subjects. Emphasis must be on critical understanding, logical reasoning and structured writing.</p> <p>Unit-I: The nature and function of research, meaning of research in the field of architecture, pure and applied research, traditional and potential areas/types, the three stages of research Research methodology, various techniques of data collection in general, specific techniques in architectural research, methods of analysis stage, communication of research reporting, the structure of a report, the necessity for the development of writing skills.</p> <p>Unit-II Technical data about formal writing, the use of visuals, the qualities of research, the use of primary and secondary references, bibliography, notation, cross reference etc. Issues of selective reference. Methods of writing draft reports before finalisation. Research in the fields of environment, community structure, architectural history and theory, urban structure, building type studies, etc.</p> <p>Unit-III Behavioural studies and user evaluation.</p>		
<p>Sessional Work (Internal semester assessment) Students are expected to present the progress of the study at various stages of the semester. Students will be asked to prepare research proposals, which will be discussed and modified.</p>		
<p>Scheme for Semester End Assessment (ESA) Final assessment of the students' work may be based on written Paper as well as oral communication. However, greater weightage may be given for writing skills and research content of the study.</p>		
<p>Mode of assessment : By the end of the semester, students are expected to submit a written paper of approximately 3500 words. Standard referencing conventions and technical writing norms must be adhered to. Students are expected to present the progress of the study at various stages of the semester.</p>		
<p>References :</p> <ol style="list-style-type: none"> 1. Murray, R. Writing for academic journals. Berkshire: Maidenhead, Open University Press. (2005). 2. Borden, I. and Ray, K. R. The dissertation: an architecture student's handbook. (2006). 3. Anderson, J. and Poole, M. Thesis and assignment writing. Brisbane: John Wiley. (1998). 4. Architectural research methods; Linda Groat & David Wang, John Wiley and sons, New York 5. Visual research methods in Design; Henry Sanoff, Van Nostrand Reinhold, New York 6. Architectural research; Snyder James C; Van Nostrand Reinhold 		

	FORM ISO 9001: 2015- KLE TECH School of Architecture	Document #: FMCD2005	Rev: 1.1
Curriculum Content- Course wise		8 Page of 27	
		Year: 2021 - 22	

Program: Architecture		
Course Title: Professional Practice I		Course Code: 18AATC405
L-T-P 3-0-0	Credits: 3	Contact Hours: 3
ISA Marks: 50	ESA Marks: 50	Total Marks: 100
Teaching Hours: 42	Examination Duration: 3 Hrs.	
Unit I 1. Architect and his Practice: Profession of architecture, duties and liabilities to the profession, Types of Architect's Office – proprietorship, partnership and combined concerns, advantages and Disadvantages of each, secure clientage, office administration and accounts of firms, Competitions, Supervision by Architects: Site Visits, Meaning and Purpose of Supervision, Remarks on Site Book, Site Meeting and Bill Checking 2. Council of Architecture (COA) and The Indian Institute of Architects (IIA) Council of Architecture (COA), Code of Professional Conduct, Architect's Act 1972, The Indian Institute of Architects (IIA), Conditions of engagement, Scale of Professional Charges, Mode of Payment, Taxation in the profession, Architect's responsibilities and liabilities towards client		
Unit II 3. Tenders – Tender documents, Types, Tendering Procedure, Tender Notice, EMD, Mobilization Fund, Security Deposit, Retention Amount, Mobilization Fund, Contractor's Profit, Work Order, and Letter of Acceptance. 4. Contracts – Definition, General Principles, Types of Contract, Importance of Articles of Agreement and Appendix, Definition of various terms and their scope. Architect's power and duties with respect to execution of contract conditions, Contractor's Duties and Liabilities under contract. Problems arising out of contract – Virtual completion and defects liability, liquidated and unliquidated damage, Penalty Bonus, Extension of Time, Non tendered items, extra and additional work, variation, prime cost and provisional sum, fire insurance and conditions of claim.		
Unit III 5. Valuation – Introduction, Essential Characteristics, Value and its classification, purpose of Classification, methods of valuation, standard rent, cost of construction.		
Text Books		
Reference Books: 1. Professional Practice – Dr. Roshan Namavati 2. Architectural Practice and Procedure – Ar. V S Apte 3. The Business of Architectural Practice – Derek Sharp 4. Architectural Practice in India – Ar. Madhav Deobhakta 5. Professional Practice – Dr. K G Krishna Murthy and Prof S V Ravindra		

	FORM ISO 9001: 2015- KLE TECH School of Architecture	Document #: FMCD2005	Rev: 1.1
Curriculum Content- Course wise			9 Page of 27
			Year: 2021 - 22

Scheme for Semester End Examination (ESA)

UNIT	8 Questions to be set of 20 Marks Each	Chapter numbers	Instructions
I	3 Questions	1 & 2	

	FORM ISO 9001: 2015- KLE TECH School of Architecture	Document #: FMCD2005	Rev: 1.1
Curriculum Content- Course wise			10 Page of 27
			Year: 2021 - 22

Program : Architecture		
Course Title: Digital Tool III (REVIT)		Course Code: 18AATC407
L-S-P: 0-0-1	Credits: 1	Contact Hours: 2
ISA Marks: 50	ESA Marks: 50	Total Marks: 100
Teaching Hours: 64	Examination Duration: NA	
COURSE OVERVIEW: Building Information Modelling is used by architects and other building professionals to help reduce risk obtain insight into how buildings will perform before construction begins, develop better quality designs, and improve project delivery. Course contents: UNIT I: 1. Building Information Modeling 2. Revit Architecture Basics 3. Starting a Design 4. The Basics of the Building Model 5. Loading Additional Building Components UNIT II: 1. Viewing the Building Model 2. Using Dimensions and Constraints 3. Developing the Building Model 4. Detailing and Drafting 5. Construction Documentation. UNIT III: Presenting the Building Model.		
Sessional Work (Internal semester assessment) <ul style="list-style-type: none"> • Assessment will be done in three parts (Minor-I, Minor-II and Final Submission). • There will submission for both the minors along with test in the lab where they will be marked. • Term work submission will be in the format of portfolio containing the compilation of all the works done throughout the semester. 		
Scheme for Semester End Assessment (ESA) <ul style="list-style-type: none"> • Portfolios will be marked on the basis of submission after ISA. 		
Mode of assessment : <ul style="list-style-type: none"> • Portfolio Submission. 		
References : Online BIM tutorial		

	FORM ISO 9001: 2015- KLE TECH School of Architecture	Document #: FMCD2005	Rev: 1.1
Curriculum Content- Course wise			11 Page of 27
			Year: 2021 - 22

Program : Architecture		
Course Title: Online Portfolio		Course Code: 18AATC406
L-S-P: 0-0-1	Credits: 1	Contact Hours: 02
ISA Marks: 50	ESA Marks: 50	Total Marks: 100
Teaching Hours: 48	Examination Duration: NA	
<p>Course contents:</p> <p>Unit-I:</p> <p>Students will learn the industry-standard publishing application to design and publish high-quality Architectural presentations and portfolio across a full spectrum of digital and print media.</p> <p>Portfolios and Presentations in Adobe InDesign, will take students through all of the steps needed to build a professional presentation and portfolio using textual description, photos of drawings, photos models, sketches etc.</p> <p>Unit-II</p> <p>Demonstrating how to set up Architectural online portfolio website using Word press (open source CMS). Create profile and upload Architectural content like: Academic assignments, design sheets, participations, Award, hobbies etc. to share with professional architects and web audience.</p> <p>Unit-III</p> <p>Installing plugins, themes, and attracting web users with permalinks, social sharing etc. in wordpress.</p>		
<p>Sessional Work (Internal semester assessment) Regular Assignments, Architectural portfolio hardcopy (booklet) and online portfolio website</p>		
<p>Scheme for Semester End Assessment (ESA) Term work: Evaluation of Portfolio booklet and online portfolio website by external examiners</p>		
<p>Mode of assessment: Printed portfolio booklet and online portfolio website</p>		
<p>References : www.adobe.com, www.wordpress.com, video tutorials and web resources</p>		

	FORM ISO 9001: 2015- KLE TECH School of Architecture	Document #: FMCD2005	Rev: 1.1
Curriculum Content- Course wise		12 Page of 27	
		Year: 2021 - 22	

Program : Architecture		
Course Title: STRUCTURES – VII		Course Code: 18AATC404
L-S-P: 0-3-0	Credits: 3	Contact Hours: 4
ISA Marks: 50	ESA Marks: 50	Total Marks: 100
Teaching Hours: 64	Examination Duration: NA	
UNIT I: <ol style="list-style-type: none"> 1. Case studies- Study of ongoing residential, public and commercial RC frame building structures by site visits. 2. Collecting data regarding the type of structural system, structural configuration, arrangement of columns, beams for the different floors. 3. Critical analysis and interpretation of data at the studio, for the possible alternative structural systems with column positions and beam layout. 		
UNIT II: <ol style="list-style-type: none"> 4. Preparing a RC structural system for an proposed architectural design of a residential, commercial and public building structures. Preparing column positions, beam layout as per requirements of all floors and parking arrangement. 5. Preparing various options of foundations can be provided for the proposed building structure. Design of typical isolated column foundation and pile foundation for the estimated axial loading Design of typical columns for the estimated gravity load subjected to axial load and uni-axial moment. Design of typical beam and slab elements for the estimated loading. 		
UNIT III: <ol style="list-style-type: none"> 6. Structural detailing - Preparing the structural drawings of layout of columns, foundation and retaining walls. Typical floor structural drawing with reinforcement details 		
Text Books : <ol style="list-style-type: none"> 1. S.R. Karve and V. L. Shah, Limit state theory and design of reinforced concrete structures publications Pune 		
Reference Books: <ol style="list-style-type: none"> 1. IS: 875- 1987 (Part – I, II and III) Code of practice Design loads other than earthquake load for building structures. 2. IS: 456- 2000 Code of practice for plane and reinforced concrete. 		

	FORM ISO 9001: 2015- KLE TECH School of Architecture	Document #: FMCD2005	Rev: 1.1
Curriculum Content- Course wise		13 Page of 27	
		Year: 2021 - 22	

Program: Architecture		
Course Title: Elective – Architecture Film Making - I		Course Code: 18AATE407
L-T-P:0-0-1	Credits: 1	Contact Hours: 2
ISA Marks:50	ESA Marks:50	Total Marks:100
Teaching Hours:32	Examination Duration: NA	
Unit I Film Pre-production Introduction to Architectural film making concepts, story board, screenplay and planning.		
Unit II Film Production Introduction to video shooting using various devices.		
Unit III Film Post-Production Video post-production techniques like editing, titles, sub titles, narration and rendering.		
Text Books		
Reference Books: Online tutorials		

Scheme for Semester End Examination (ESA)

Assignments, Checking of Portfolio of Term Work / Viva.

 KLE TECH.	FORM ISO 9001: 2015- KLE TECH School of Architecture	Document #: FMCD2005	Rev: 1.1
Curriculum Content- Course wise			14 Page of 27
			Year: 2021 - 22

Program : Architecture		
Course Title: SUSTAINABLE DEVELOPMENT OF LIVING HERITAGE-II		Course Code: 18AATE408
L-S-P: 0-2-0	Credits: 2	Contact Hours: 2 hrs.
ISA Marks: 50 marks	ESA Marks: 50 marks	Total Marks: 100
Teaching Hours: 32	Examination Duration: NA	
UNIT I: Definition of Cultural Heritage, Cultural Landscape, Monuments & site (UNESCO operational guidelines) Documentation of the Heritage Site Need for conservation of living cultural heritage sites. Values & Ethics in heritage conservation Charters		
UNIT II: Mapping Analysis Draft Proposals and report		
UNIT III: 1. Final proposal and report		
Text Books: Nil		
References : Nil		

	FORM ISO 9001: 2015- KLE TECH School of Architecture	Document #: FMCD2005	Rev: 1.1
Curriculum Content- Course wise		15 Page of 27	
		Year: 2021 - 22	

Program : Architecture		
Course Title: Transit Oriented Development		Course Code: 18AATE409
L-S-P: 0-2-0	Credits: 2	Contact Hours: 2 hrs.
ISA Marks: 50 marks	ESA Marks: 50 marks	Total Marks: 100
Teaching Hours: 32	Examination Duration: NA	
Course contents: Unit-I: Introduction to Transit Oriented Development Theories and Principals of TOD Examples of TOD Unit-II Study, Analysis and Design of an identified area along a transit Corridor using Principles of TOD and Infrastructure Unit-III Research Paper on any one principal or component of Transit Oriented Development		
Sessional Work (Internal semester assessment)		
Scheme for Semester End Assessment (ESA)		
Mode of assessment: Checking of Portfolio of Term Work / Viva		
References: Nil		

	FORM ISO 9001: 2015- KLE TECH School of Architecture	Document #: FMCD2005	Rev: 1.1
Curriculum Content- Course wise			16 Page of 27
			Year: 2021 - 22

Program : ARCHITECTURE		
Course Title: ARCHITECTURAL LIGHTING		Course Code: 18AATE410
L-S-P: 0-2-0	Credits: 2	Contact Hours: 2
CIE Marks: 50	SEE Marks: 50	Total Marks:
Teaching Hours: 32	Examination Duration:	
UNIT I: <ol style="list-style-type: none"> 1. The history of architectural lighting 2. Basics of Lighting Design 3. Terminology and units 4. Types of Light and light sources 5. Control gear and control equipment 		
UNIT II: <ol style="list-style-type: none"> 6. Light – Qualities and features 7. Controlling light 8. Luminaries 9. Lighting design 10. Lighting design and analysis tools 		
UNIT III: <ol style="list-style-type: none"> 8. Exercise: Design of Lighting for a sample space. 		
Text Books: NIL		
Reference Books: <ul style="list-style-type: none"> • Handbook of Lighting Design by Rudiger Ganslandt and Harald Hofmann • Lighting Design Basics by Mark Karlen • Designing With Light: The Art, Science and Practice of Architectural Lighting Design by Jason Livingston. • The Architecture of Light (2nd Edition): A textbook of procedures and practices for the Architect, Interior Designer and Lighting Designer. 		

	FORM ISO 9001: 2015- KLE TECH School of Architecture	Document #: FMCD2005	Rev: 1.1

Semester: VIII (2018-19)

Sr.No	Course code	Course Title	Period			Evaluation
			L	T	P	ISA
1	18AATT401	Professional Training	0	22	0	50
TOTAL			0	22	0	50

ISA: In-semester Assessment **ESA:** End Semester Assessment **L:** Lecture **T:** Tutorials **P:** Practical

Credit	Lecture Hours	Studio Hours	Practical Hours
1	1	1.5	2

Program Head

Signature of Dean (Academic Affairs)

	FORM ISO 9001: 2015- KLE TECH School of Architecture	Document #: FMCD2005	Rev: 1.1
Curriculum Content- Course wise			18 Page of 27
			Year: 2021 - 22

Program : Architecture		
Course Title: Professional Training		Course Code: 18AATT401
L-S-P: 0-22-0	Credits: 22	Contact Hours: 30
CIE Marks: 50	SEE Marks: 50	Total Marks: 100
Teaching Hours: 420	Examination Duration: NA	
<p>UNIT-1</p> <p>The Student is expected to be exposed to preparation of working drawing, detailing, preparation of architectural models, computer applications in design and drafting, filing system in respect of documents, drawing and preparation of tender, documents. Site experience may be given in respect of supervision of the construction activity, observing the layout on site, study of the stacking methods of various building materials, study of taking measurement and recording.</p> <p>Students will have to maintain a day to day record of their engagement for the period of training. This will be recorded in an authorized diary to be counter signed by the architect at the end of each month and the same diary shall be sent to the department once in a month. At the end of the training period, a student will have to produce a certificate of experience and satisfactory performance from the concerned office in the prescribed format.</p> <p>UNIT-II</p> <p>The viva-voce marks shall be awarded based on the following works to be submitted by the student and presented during the viva.</p> <p>Training Report: this shall contain copies of various drawing done by the student either drafted or designed. It shall also contain other works like photographs of site visited, models done, computer output produced etc.,</p> <p>Building study – This shall be a detailed critical study of a building designed by the architect with whom the student has worked. It shall include the study of function, aesthetics, context, structure etc., This shall be presented through drawings, photographs, write ups etc.,</p> <p>UNIT-III</p> <p>Building Materials Study – This shall be a detailed study of a new or relatively new building material available in the market. A study of its properties, uses, cost, maintenance etc., is expected to be done. Samples of materials shall also be obtained and presented.</p> <p>Detailed Study – This shall be a study of any interesting detail done in the firm where the student has undertaken training. This shall include sketches and photographs of the detail.</p> <p>A Candidate failing in the viva examination shall repeat the training afresh for 16 weeks, the starting date coinciding with the beginning of a subsequent semester.</p>		
<p>Objectives of the course:</p> <p>To provide exposure to the various dimensions of architectural practice.</p>		

	FORM ISO 9001: 2015- KLE TECH School of Architecture	Document #: FMCD2005	Rev: 1.1
Curriculum Content- Course wise			19 Page of 27
			Year: 2021 - 22

Text Books: NIL
Reference Books: NIL

	FORM ISO 9001: 2015- KLE TECH School of Architecture	Document #: FMCD2005	Rev: 1.1
Curriculum Content- Course wise		1 Page of 12	
		Year:2021-22	

**School of Architecture,
KLE Technological University,
BVBCET Campus, Vidyanagar, Hubli.**

CURRICULUM SCHEME & SYLLABUS OF **IX Semester – X Semester**

(Year of introduction-2015, Faculty-A, Architecture-AT, Core course-C, Humanities-H, Lab-L, Elective-E, internship-I, Practice-p, W-Project)

	FORM ISO 9001: 2015- KLE TECH School of Architecture	Document #: FMCD2005	Rev: 1.1
			Year:2021-22

Semester: IX (2017-18)

Sr.No	Course code	Course Title	Period			Evaluation scheme			Credit (L+T+P)	Hours
			L	T	P	ISA	ESA	Sub total		
1	17AATT501	Professional Training	0	22	0	50	50	100	22	18
TOTAL			0	22	0	50	50	100	22	18

ISA: In-semester Assessment **ESA:** End Semester Assessment **L:** Lecture **T:** Tutorials **P:** Practical

Credit	Lecture Hours	Studio Hours	Practical Hours
1	1	1.5	2

Program Head

Signature of Dean (Academic Affairs)

	FORM ISO 9001: 2015- KLE TECH School of Architecture	Document #: FMCD2005	Rev: 1.1

Semester: X (2017-18)

Sr.No	Course code	Course Title	Period			Evaluation scheme			Credit (L+T+P)	Hours
			L	T	P	ISA	ESA	Sub total		
1	17AATC501	Architectural Design - IX (Thesis Project)	0	20	0	50	50	100	20	18
2	17AATE501 Onwards	Electives-VI	0	2	0	50	50	100	2	2
TOTAL			0	22	0	100	100	200	22	20

ISA: In-semester Assessment **ESA:** End Semester Assessment **L:** Lecture **T:** Tutorials **P:** Practical

Credit	Lecture Hours	Studio Hours	Practical Hours
1	1	1.5	2

Program Head

Signature of Dean (Academic Affairs)

	 KLE Technological University Creating Value Leveraging Knowledge	Document #: FMCD2005	Rev: 1.0
Title: Curriculum Content- Course wise			Page 4 o12 Year:2020

IX SEMESTER

 KLE Technological University <small>Creating Value Leveraging Knowledge</small>	Document #: FMCD2005	Rev: 1.0
	Title: Curriculum Content- Course wise	

Page 5 of 12

Year:2020

Program : Architecture		
Course Title: Professional Training		Course Code: 17AATT501
L-S-P: 0-22-0	Credits: 22	Contact Hours: 30
CIE Marks: 50	SEE Marks: 50	Total Marks: 100
Teaching Hours: 420	Examination Duration: NA	
<p>UNIT-1</p> <p>The Student is expected to be exposed to preparation of working drawing, detailing, preparation of architectural models, computer applications in design and drafting, filing system in respect of documents, drawing and preparation of tender, documents. Site experience may be given in respect of supervision of the construction activity, observing the layout on site, study of the stacking methods of various building materials, study of taking measurement and recording.</p> <p>Students will have to maintain a day to day record of their engagement for the period of training. This will be recorded in an authorized diary to be counter signed by the architect at the end of each month and the same diary shall be sent to the department once in a month. At the end of the training period, a student will have to produce a certificate of experience and satisfactory performance from the concerned office in the prescribed format.</p> <p>UNIT-II</p> <p>The viva-voce marks shall be awarded based on the following works to be submitted by the student and presented during the viva.</p> <p>Training Report: this shall contain copies of various drawing done by the student either drafted or designed. It shall also contain other works like photographs of site visited, models done, computer output produced etc.,</p> <p>Building study – This shall be a detailed critical study of a building designed by the architect with whom the student has worked. It shall include the study of function, aesthetics, context, structure etc., This shall be presented through drawings, photographs, write ups etc.,</p> <p>UNIT-III</p> <p>Building Materials Study – This shall be a detailed study of a new or relatively new building material available in the market. A study of its properties, uses, cost, maintenance etc., is expected to be done. Samples of materials shall also be obtained and presented.</p> <p>Detailed Study – This shall be a study of any interesting detail done in the firm where the student has undertaken training. This shall include sketches and photographs of the detail.</p> <p>A Candidate failing in the viva examination shall repeat the training afresh for 16 weeks, the starting date coinciding with the beginning of a subsequent semester.</p>		
<p>Objectives of the course:</p> <p>To provide exposure to the various dimensions of architectural practice.</p>		
Text Books: NIL		
Reference Books: NIL		

	 <p>KLE Technological University Creating Value Leveraging Knowledge</p>	Document #: FMCD2005	Rev: 1.0
Title: Curriculum Content- Course wise			Page 6 o12
			Year:2020

	 KLE Technological University Creating Value Leveraging Knowledge	Document #: FMCD2005	Rev: 1.0
		Page 7 of 12	
		Year:2020	

X SEMESTER

Program : Architecture		
Course Title: Architectural Design - IX		Course Code: 17AATC501
L-S-P: 0-20-0	Credits: 20	Contact Hours: 18
ISA Marks: 50	ESA Marks: 50	Total Marks: 100
Teaching Hours: 252	Examination Duration: NA	
<p>Course contents:Thesis project is the culmination of the Undergraduate program in architecture. In thesis a student is expected to undertake an in-depth investigation of an area of architecture that he/she is interested in. Students are required to develop the design as per the design objectives and design brief submitted in the report during Pre thesis. A full-fledged large scale Architectural Design with holistic approach including site Investigation, Design programme formulation, Structural considerations, Interior space planning, Environmental planning, Building Services, Climate responsiveness shall be demonstrated.</p> <p>Unit-I:</p> <ul style="list-style-type: none"> Architectural Project shall consist of a graphically presented Design solution in form of sufficient number of architectural drawings with models, views. 		

 KLE Technological University <small>Creating Value Leveraging Knowledge</small>	Document #: FMCD2005	Rev: 1.0
	Title: Curriculum Content- Course wise	
		Page 8 of 12
		Year:2020

- It is expected that students demonstrates an ability of holistic and comprehensive thinking in the areas of Site Planning, Interior space planning, Climate responsive design.

Unit-II:

- Architectural Project shall consist of a graphically presented Design solution in form of sufficient number of architectural drawings with models, views etc.
- It is expected that the students demonstrates an ability of holistic and comprehensive thinking in the areas of Environmental planning, Building Services, sustainable architecture and Architectural Detailing.
- Architectural thesis report addressing the above mentioned areas.

Unit-III:

- Design Portfolio of graphically presented Design solution in totality with the models and an Architectural thesis.

Sessional Work -Internal semester assessment (ISA)

The Internal assessment of Architectural Thesis Project shall be carried out Stage wise during the reviews as decided by the School.

Scheme for Semester End Assessment (ESA)

The final assessment in the examination shall be done by Internal and External Examiner / s in which the students will display the work and explain their work and answer all the queries raised by the Examiners.

The Time allotted per student shall be minimum 20 minutes to maximum 30 minutes.

The Internal stage wise marking shall be done out of 50 marks and External marking shall be done jointly by the External Examiner/s out of 50 marks. 5 marks shall be reserved for oral presentation to be assessed jointly by both Internal and External Examiners.

Mode of assessment : Stage wise reviews (internal and external) for ISA and External Jury for ESA

References :

- Design Methods by Jones C. J. (1992) John Willey and Sons, Inc.
- How Designers think: the design process demystified by Lawson B.2005 ,Architectural Press, Oxford

Electives

Program : Architecture		
Course Title: Barrier Free Architecture		Course Code:15AATE501
L-S-P: 0-2-0	Credits: 2	Contact Hours: 2
ISA Marks: 50	ESA Marks: 50	Total Marks: 100
Teaching Hours: 28	Examination Duration: NA	
Course Objectives:		
To understand and inculcate skills required for designing for barrier free built environments for for persons with disabilities and elderly persons. Techniques involved in making such provisions.		
Course contents:		
Unit-I		
Introduction to Provisions of persons with Disabilities Act, 1995, Type of disabilities, National Policy for provisions for elderly persons, Concept of equal opportunity, human rights, social justice and empowerment of physically challenged persons. Initiatives at global and International level for protection of rights of disabled and also elderly person.		

 KLE Technological University <small>Creating Value Leveraging Knowledge</small>	Document #: FMCD2005	Rev: 1.0
	Title: Curriculum Content- Course wise	

American disabilities Act 1990 etc.

Unit-II

National Institutes, agencies and professional bodies involved in disabled welfare, associated norms and standards thereof.

Design principles in Architecture for creating environments friendly for various types of physically challenged persons. Educational Institutions, Hospitals, Transportation terminals such as bus, railway stations and airports for barrier free spaces. Study of Standards as given in TSS, TCPO, CPWD ADA etc., and others

Unit-III

Provisions in public spaces and site planning – parks, play grounds, public transportation, parking lots, Details of sidewalks, road intersections, access to public toilets.

Provisions in design of public buildings –Details in, ramps, guide rails, lifts, dimensions of wheel chairs, accessibility in public buildings, Signage, audio visual facilities etc. Design of Toilets and interiors spaces for use of physically challenged.

Scheme for Internal semester assessment (ISA)

Reworking on Previous semester Design Projects to design barrier free spaces.

Scheme for Semester End Assessment (ESA)

Site planning: 30%, Design of Built spaces: 30%, Design of details:40%

Mode of assessment : Evaluation of assignments by internal and external examiners

References :

1. Micheal J.Bednar. "Barrier Free Environments", Dowden, Hutchinson and Ross, Ive 1977.
2. Ministry of Urban Affairs and Employment. Central Public Works Department, India, "Guidelines and Space Standards for Barriers Free Environment for Disabled and Elderly Person, 1998.
3. Unnati. " Design Manual for a Barrier – Free Built Environment" , Handicap International, December, 2004
4. Building without barriers for the disabled, Harkness,

Program : Architecture		
Course Title: Human Centered Design		Course Code: 15AATE502
L-S-P: 0-2-0	Credits: 2	Contact Hours: 2
ISA Marks: 50	ESA Marks: 50	Total Marks: 100
Teaching Hours: 28	Examination Duration: NA	
<p>Course contents:</p> <p>Understanding Design as a very old human capability that has been forgotten by the mainstream educational system and traditionalist alike.A modern human activity that can help the products,services and policies of the future within the constraints of our contexts.</p> <p>Unit-I:</p> <p>What is Design?</p> <p>Multiple Dimensions of Design,Processes and Applications</p> <p>What is Human Centered Design?</p> <p>1 Looking: Observing Human Experience</p>		

 KLE Technological University Creating Value Leveraging Knowledge	Document #: FMCD2005	Rev: 1.0
	Title: Curriculum Content- Course wise	

2 Understanding: Analyzing challenges and opportunities 3 Making: Envisioning Future Possibilities Unit-II HCD to identify problem. Unit-III Field Work, Define, Ideate, Prototype(Concept design, Detailed Design) ,Test, Feedback
Scheme for Internal semester assessment (ISA) Field work Ideation, Concept design,Final Design Periodic reviews presentations of finding , concerns, Development stage of product and justification
Scheme for Semester End Assessment (ESA) Final Report Prototype design
Mode of Assessment: Field work attendance Assignment
References: <ol style="list-style-type: none"> 1. Harold Nelson: The Design Way Intensions/Compositions/Value 2. John Heskett :Toothpics and Logos Objects/Communication/Environments/Identities/Systems/Contexts/Future 3. Klaus Krippendorff:The Semantic Turn ,Meaning of Artifact in :Use/Language/Life Cycle/Ecology

Program : ARCHITECTURE		
Course Title: SUSTAINABLE ARCHITECTURE		Course Code: 15AATE503
L-S-P: 0-2-0	Credits: 2	Contact Hours: 2
CIE Marks: 50	SEE Marks: 50	Total Marks: 100
Teaching Hours: 28	Examination Duration: NA	
UNIT I: <ol style="list-style-type: none"> 1. Introduction to Sustainable Architecture 2. Approaches to Sustainable Design 3. Concept of Cradle to Cradle 4. Life Cycle Analysis 		

 KLE Technological University <small>Creating Value Leveraging Knowledge</small>	Document #: FMCD2005	Rev: 1.0
	Title: Curriculum Content- Course wise	

UNIT II:

5. Principles of Building Physics for Sustainable Design
6. Sustainable Urban Spaces and Landscape Design
7. Building Skins and Façade Design
8. Sustainable Indoor Spaces
9. Passive Design Strategies
10. Professional Responsibility in Sustainable Environmental Design

UNIT III:

11. Design Project for Demonstration of the Learning.

Scheme for Internal semester assessment (ISA)

Termwork and assignments evaluation by internal examiner

Scheme for Semester End Assessment (ESA)

Termwork and assignments evaluation by internal and External examiner

Mode of Assessment: Evaluation of assignments by internal and external examiners

Text Books: NIL

Reference:

Program : Architecture		
Course Title: Special Facilities Planning		Course Code: 15AATE504
L-S-P: 0-2-0	Credits: 2	Contact Hours: 2
ISA Marks: 50	ESA Marks: 50	Total Marks: 100
Teaching Hours: 28	Examination Duration: N/A	
<p>Course contents:</p> <p>UNIT-I Understanding the Facilities context.:</p> <p>Facility needs, The Building cycle, Leasing or buying, User Requirements and Building information, Over view of URM. Facility management and space management concepts, Facilities management functions, User requirements and Meeting space</p>		

 KLE Technological University Creating Value Leveraging Knowledge	Document #: FMCD2005	Rev: 1.0
	Title: Curriculum Content- Course wise	
		Page 12 of 12
		Year:2020

Requirements, space evaluation and space management. Facilities Utilization, concepts, assessing Utilization, role of User requirements in Utilization.

UNIT-II Fundamentals of URM.

URM Terminology, ready to apply URM, staffing URM, getting organized for URM. Analysing operations and activities, Defining User Requirements, Communicating User Requirements.

UNIT-III Applications and modifications of URM.

URM Applications- Flexibility of URM, Evaluating existing buildings, (Lease or purchase)
Evaluating currently occupied buildings, Standardized spaces and facilities, Facilities and space management.. Using computers with URM, Computers with facilities planning, CAD & CAFM, Graphics/ DBMS combined.

Scheme for Internal semester assessment (ISA)

Termwork and assignments evaluation by internal examiner

Scheme for Semester End Assessment (ESA)

Termwork and assignments evaluation by internal and External examiner

Mode of Assessment: Evaluation of assignments by internal and external examiners

References :

1. Facilities Planning The User Requirements Method Second Edition, Roger L. Brauer

Program : ARCHITECTURE		
Course Title: Building Performance Analysis & Appraisal		Course Code: 15AATE505
L-S-P: 0-2-0	Credits: 2	Contact Hours: 2
CIE Marks: 50	SEE Marks: 50	Total Marks: 100
Teaching Hours: 28	Examination Duration:	
UNIT I:		
Introduction to Building Performance Analysis		
Introduction to Building Information Modeling		
Introduction to the appraisal process and certifications		

	 KLE Technological University <small>Creating Value Leveraging Knowledge</small>	Document #: FMCD2005	Rev: 1.0
Title: Curriculum Content- Course wise			Page 13 of 12 Year:2020

UNIT II:

Introduction: Building Performance Analysis

Energy Literacy & Building Loads

Climate & Weather Analysis

Solar Measurements & Strategies

Wind & Airflow Strategies

Day lighting Strategies & Analysis

Whole Building Energy Optimization

UNIT III:

Appraisal and Certifications like Energy Star, IGBC, REC, Clean Energy Certificate, Net Zero Energy Building certification, GRIHA, BEE rating etc

Scheme for Internal semester assessment (ISA)

Termwork and assignments evaluation by internal examiner

Scheme for Semester End Assessment (ESA)

Termwork and assignments evaluation by internal and External examiner

Mode of Assessment: Evaluation of assignments by internal and external examiners

Text Books:NIL

Reference:

1. Teri GRIHA
2. IGBC Website
3. BEE Website
4. Autodesk : Sustainability Workshop

1.1.3. Number of courses having focus on employability/ entrepreneurship/ skill development during the year.

Year of offering: 2021-22

Batch- 2020-24 (3rd semester)

Program: Biotechnology		
Course Title: Numerical Methods and Differential Equations		Course Code: 20EMAB205
L-T-P: 4-0-0	Credits: 4.0	Contact Hours: 04 Hours/Week
ISA Marks: 50	ESA Marks: 50	Total Marks: 100
Teaching Hours: 40	Examination Duration: 03 Hours	
Unit I		
1. Interpolation techniques		
Finite differences, Forward, Backward and central difference Operators. Newton Gregory forward and backward interpolation formulae. Stirling's formula for central difference. Newton's divided difference formula for unequal intervals.		
08 Hours		
2. Numerical Solution of Partial Differential Equations		
Introduction, Classification of PDE, Parabolic, Elliptic and Hyperbolic Partial differential equations, Introduction to finite difference approximations to derivatives, finite difference solution of parabolic PDE, explicit and implicit methods, finite difference method to Elliptic PDE-initial –boundary value problems, Hyperbolic PDE-explicit method. Engineering problems: Temperature distribution in a heated plate, steady-state heat flow and vibration of a stretched string.		
12 Hours		
Unit II		
3. Matrices and System of linear equations		
Introduction to system of linear equations, Elementary row transformations, Rank of a matrix, Consistency of system of linear equations, solution of system by (i) Direct methods-Gauss elimination, Gauss Jordan method (ii) Iterative method - Gauss-Seidel method. Eigen values and Eigenvectors of a matrix. Largest Eigen value and the corresponding Eigenvector by power method. Engineering problems.		
08 Hours		
4. Introduction to Statistics		
Introduction, Scope of biostatistics, Variables, Measurement scales, Ordered array, Graphical representation of data: Bar Chart, Line chart, histogram, frequency curve, Ogive curves. Descriptive statistics: Measure of central tendency (arithmetic mean, median, mode, quartiles); Measures of dispersion (Quartile deviation, Standard deviation, coefficient of variation), Measure of skewness (Pearson and Bowley's)		
12 Hours		

Unit III

5. Introduction to Laplace transform and Solution of Differential Equations

Definition, transforms of elementary functions- transforms of derivatives and integrals-Properties. Periodic functions, Unit step functions and Unit impulse functions. Inverse Transforms- properties- Convolution Theorem. Applications to differential equations

10 Hours

Text Books:

1. Numerical methods for Engineers, Chapra S C and Canale R P, 5ed, TATA McGraw-Hill, 2007
2. Advanced Engineering Methods, Kreyszig E. 8Ed, John Wiley & sons, 2003.
3. Applied Statistics and Probability for Engineers, Douglas Montgomery, George Runger, 6Ed, John Wiley, 2014

Reference Books:

1. Introduction to Probability and Statistics: Principles and Applications for Engineering and Computing, J.Susan Milton, Jesse C Arnold, , 4, TATA Mc-Graw Hill Edition, 2007
2. Fundamentals of Mathematical Statistics, Gupta S.C and Kapoor V.K, 11Ed, Sultan Chand & Sons, New Delhi, 2002
3. Higher Engineering Mathematics, Grewal B S, 38ed, Khanna Publication, New Delhi, 2001.

Scheme for End Semester Assessment (ESA)

UNIT	8 Questions to be set of 20 Marks Each	Chapter numbers	Instructions
I	3 Questions to be set of 20 Marks Each	1, 2	Solve Any 2 out of 3
II	3 Questions to be set of 20 Marks Each	3,4	Solve Any 2 out of 3
III	2 Questions to be set of 20 Marks Each	5	Solve Any 1 out of 2

Program: Biotechnology		
Course Title: Microbiology		Course Code: 15EBTC201
L-T-P: 4-0-0	Credits: 4.0	Contact Hours: 04 Hours/Week
ISA Marks: 50	ESA Marks: 50	Total Marks: 100
Teaching Hours: 50	Examination Duration: 03 Hours	
Unit I		
<p>1. Introduction The scope of Microbiology, Historical Foundations, Taxonomy and classification of microorganisms, Bergey's Manual of Systematic Bacteriology, prokaryotic and eukaryotic cells, Eubacteria and Archaeobacteria, study of different types of microorganisms: bacteria, yeasts, viruses, fungi, protozoa (structure, classification, modes of reproduction & growth). Microbes and human society: Microbial applications in agriculture, veterinary, healthcare, industry and environment.</p> <p style="text-align: right;">05 hours</p>		
<p>2. Functional anatomy of Prokaryotic and Eukaryotic cells: Size, shape and arrangement of bacterial cells, structures external to cell wall, cell wall and structures internal to cell wall including endospores. Structure and functions of eukaryotic cell. Genome structure in prokaryotic and Eukaryotic cells, Genotype & Phenotype, Genetic transfer and recombination (Transformation, Conjugation & Transduction), Genes and evolution.</p> <p style="text-align: right;">07 hours</p>		
<p>3. Microscopic Examination Bright-field Microscopy, Dark-field Microscopy, Phase-contrast Microscopy, Fluorescence Microscopy and Electron Microscopy. Preparation of specimen for light and electron microscopy. Advances in Scanned Probe Microscopy, Scanning Tunneling Microscopy, Atomic Force Microscopy.</p> <p style="text-align: right;">04 hours</p>		
<p>4. Microbial Growth The requirements for growth (Physical & Chemical requirements), Culture media & their classification, Effect of different factors on growth, Growth of bacterial culture: bacterial division, generation time, phases of growth. Fundamentals of microbial growth Kinetics. Chemostat & Turbidostat, Measurement of growth: Direct and Indirect methods.</p> <p style="text-align: right;">04 hours</p>		

Unit II

5. Microbial Techniques

Pure culture techniques (streak plate, spread plate, pour plate), Staining techniques (simple and differential staining techniques), Enumeration techniques (Direct Microscopic Count, plating techniques, membrane filtration, Electronic enumeration, etc). Characterization: Phenotypic and Biochemical characterization. 16S rRNA gene homology.

10 hours

6. Microbial Metabolism

Catabolic and Anabolic reactions, Energy production, Carbohydrate catabolism: Glycolysis, Alternatives to Glycolysis, Cellular respiration, Energy production by aerobic process, Energy production by anaerobic process, Energy production by photosynthesis, Mechanism of ATP synthesis. Lipid and Protein catabolism, Photosynthesis: Light dependent and light independent reactions. Metabolic diversity among microorganisms: autotrophs and heterotrophs. Metabolic pathways of energy use: Polysaccharide biosynthesis, lipid biosynthesis, amino acid and protein biosynthesis. The integration of metabolism. Utilization of Energy and Biosynthesis: Utilization of energy for biosynthetic and non-biosynthetic processes.

10 hours

Unit III

7. Control & Preservation of Microorganisms

Control of microorganisms by physical methods (heat, filtration, radiation). Microbial death kinetics, Thermal death point, Thermal death time, Decimal reduction time. Control of microorganisms by chemical methods (phenols, alcohols, halogens, dyes, detergents, heavy metals, etc), Common preservation techniques for microbes.

05 hours

8. Applied and Industrial Microbiology

Food Microbiology, role of microorganisms in food production, Industrial Microbiology: Introduction to Fermenter & fermentation processes, Media for industrial application, Industrial Products: amino acids, vitamins, enzymes, pharmaceuticals, organic acids (discussion of case study), r-DNA technology & therapeutic products from microbes. Biosynthetic pathways and Introduction to Metabolic Engineering.

05 hours

Text Books:

- 1 Chan & Pelzar, Microbiology, Publisher: Tata McGraw Hill 5th Edition 2008.
- 2 Tortora, Microbiology: An Introduction, Publisher: Pearson Education, 8th Edition, 2004

Reference Books:

1. Stanier Ingraham & Wheeler, General Microbiology, Pub: Mac Millan 5th edition. 2007.
2. Heritage, Introductory Microbiology Pub: Cambridge, 1st edition, 2007

Scheme for End Semester Assessment (ESA)

UNIT	8 Questions to be set of 20 Marks Each	Chapter numbers	Instructions
------	--	-----------------	--------------

I	3 Questions to be set of 20 Marks Each	1, 2, 3,4	Solve Any 2 out of 3
II	3 Questions to be set of 20 Marks Each	5,6	Solve Any 2 out of 3
III	2 Questions to be set of 20 Marks Each	7,8	Solve Any 1 out of 2

Program: Biotechnology		
Course Title: Biochemistry		Course Code: 15EBTC202
L-T-P: 4-0-0	Credits: 4.0	Contact Hours: 04 Hours/Week
ISA Marks: 50	ESA Marks: 50	Total Marks: 100
Teaching Hours: 50	Examination Duration: 03 Hours	

Unit I

1. Biochemical Foundation & Carbohydrates

Types of chemical reactions, Solution chemistry. pH (Henderson-hasselbatch equation) Buffers and their Biological importance, carbohydrates- chemical structure and properties classification- Monosaccharide's, Disaccharides, Sugar derivatives, deoxy sugars, amino sugars, and sugar acids, phosphorylated sugars, structure and properties of polysaccharides, Homopolysaccharides, Heteropolysaccharides - Peptidoglycan, Glycosaminoglycans, Glycoconjugates, Glycobiology . Biological importance of carbohydrates. **07 Hours**

2. Lipids

Definition and classification of lipid – simple, compound and derived lipids. Structure, classification and properties of fatty acids, Essential and non-essential fatty acid with physiological importance. Structure and physiological functions of phospholipids, Sphingolipids, cerebrosides and gangliosides. Steroids- Structure and functions of cholesterol,. Eicosanoids, lipoproteins and terpenes. Vitamins-classifications and functions **05 Hours**

3. Amino acids and Proteins

Definition, Classification and properties of amino acids, reactions, rare amino acids, essential and nonessential amino acids with physiological importance. Peptides - Definition of peptide bond, Biologically important peptides. Proteins – Classification- primary, secondary- Alpha helix, Beta sheets, tertiary and quaternary proteins-hemoglobin. Ramachandran plot, polypeptide sequencing- Edman degradation, Chemical synthesis of Peptides. **05Hours**

4. Nucleic acids

Structure and properties of purines, pyrimidines, nucleosides and nucleotides. Nucleic acids- Structure of DNA, RNA -Types, **03 Hours**

Unit II

5. Carbohydrate metabolism

Glycolysis-aerobic and in anaerobic pathway, Energy yield of glycolysis Regulation of glycolysis-metabolic and hormonal. Fates of pyruvate. Glycogen - synthesis and degradation. Regulation of glycogen metabolism. Gluconeogenesis, Pentose phosphate pathway. Significance of pentose phosphate pathway and regulation. Production of Acetyl-CoA, Reactions of Citric acid cycle, Anaplerotic reactions, regulation of citric acid cycle. Glyoxylate cycle, Electron transport chain, ATP synthesis, shuttle systems and Oxidative phosphorylation. Cyclic and Non-cyclic Photophosphorylation and Calvin Cycle (C3) in plants Disorders of carbohydrate metabolism. Production of microbial polysaccharides; industrial and Medical application of exopolysaccharides.

10 Hours

6. Metabolism of Amino acids

General reactions of amino acid metabolism, urea cycle, amino acid biosynthesis-aspartate and glutamate family and degradation of aromatic amino acid - phenylalanine and tyrosine, metabolic disorders of amino acid metabolism, biosynthesis of plant substances and neurotransmitters, Environmental and Industrial Significance of Amino acid metabolism.

05 Hours

7. Metabolism of Fatty acids

Fatty acid oxidation, biosynthesis of fatty acids, Ketone bodies, phospholipids and spingolipids cholesterol biosynthesis, Regulation, metabolic disorders of lipid metabolism. Environmental and Industrial Significance of lipid metabolism

05 Hours

Unit III

8. Metabolism of Nucleic acids

Biosynthesis and degradation of purines and pyrimidines, salvage pathway, uric acid production, regulation, metabolic disorders of nucleic acid metabolism.

05 Hours

9. Biological Membranes And Transport Mechanism

Composition and functions of biological membranes (fluid mosaic model) – Proteins, Carbohydrates, Glycoprotein and glycolipids, Membrane transport - Passive transport and Active transport. Mechanism of Na⁺ and K⁺, glucose and amino acid transport. Role of transport in signal transduction processes.

05 Hours

Text Books

1. David L. Nelson, Michael M. Cox, Lehninger Principles of Biochemistry, Sixth Edition, W.H. Freeman, 2012.
2. Jeremy M. Berg, John L. Tymoczko, Lubert Stryer. , Biochemistry, 7th revised International edition, Palgrave MacMillan, 2011.

Reference Books

1. Donald Voet and Judith G. Voet. , Biochemistry, 4th edition, Wiley; , 2010
2. Geoffrey L. Zubay, Principles of Biochemistry , Edition: 4th, William C Brown Pub, 1999.

Scheme for End Semester Assessment (ESA)

UNIT	8 Questions to be set of 20 Marks Each	Chapter numbers	Instructions
I	3 Questions to be set of 20 Marks Each	1, 2, 3,4	Solve Any 2 out of 3
II	3 Questions to be set of 20 Marks Each	5,6,7	Solve Any 2 out of 3
III	2 Questions to be set of 20 Marks Each	8,9	Solve Any 1 out of 2

Program: Biotechnology		
Course Title: Bioprocess Calculations		Course Code: 15EBTF201
L-T-P: 4-0-0	Credits: 4	Contact Hours: 04 Hours/Week
ISA Marks: 50	ESA Marks: 50	Total Marks: 100
Teaching Hours: 50	Examination Duration: 03 Hours	
Unit I		
1.Units and dimensions		
Introduction to Fundamental and derived Units. FPS, MKS, CGS and SI system. Conversion from one system to another system with examples.		
04 Hours		
2.Basics of chemical calculation		
Introduction, concept of mole, Atomic mass and molar mass, composition of mixtures of solids, liquids and gaseous. Ideal gas law, Amagats law and Dalton's law. Varification of Vol %=Mol %.		
Physical properties of solution, normality, morality and molality. Solving problems for normality, morality and molality.		
08 Hours		
3.Material balances without chemical reaction		
General material balance equation, simplification for steady state without chemical reaction. Material balances of unsteady-state operation. Problems on mixing of streams, Distillation, Drying, Absorption, evaporation, Filtration, Extraction & Crystallization.		
08 Hours		

Unit II

4. Material balances with chemical reaction

Introduction, Concept of limiting, excess reactant and inerts. Conversion, yield and selectivity. Fuels and combustion-Definition of ultimate and proximate analysis of coal, air fuel ratio calculation. Problems.

10 Hours

5. Energy Balance

General steady state energy balance Equation. Thermodynamics-Enthalpy, Heat capacities of solids, liquids and gases. Heat capacities of mixture, Thermo chemistry-Heat of combustion, formation and reaction. Effect of temperature on heat of reaction. Definition and significances of NCV and GCV and problems.

10 Hours

Unit III

6a .Stoichiometry of microbial growth and product formation kinetics

Introduction and definition of various yield coefficients. Elemental balances and Degree of reduction. Problems.

05 Hours

6b .Stoichiometry of microbial growth and product formation kinetics

Introduction and Basic cell kinetic models, Structured, unstructured and mixed growth kinetic models

05 Hours

Text Books

1. B.I Bhatt and S.M.Vora, Stoichiometry, Tata McGraw Hill publications, 4th edn, 2007.
2. David Himmelblau, Basic principles and calculation in chemical engineering, Pearson Education Limited, 6th edn, 2005

Reference Books

- 1) Hougen, Watson and Rigatz, Chemical Process principles Part-I , CBS Publishers & Distributors, 2nd edn, 2004.
- 2) J E Bailey and D F Ollis, Biochemical engineering Fundamentals, McGraw Hill Publication, 2nd edn, 1986.

Scheme for End Semester Assessment (ESA)

UNIT	8 Questions to be set of 20 Marks Each	Chapter numbers	Instructions
I	3 Questions to be set of 20 Marks Each	1, 2, 3,	Solve Any 2 out of 3
II	3 Questions to be set of 20 Marks Each	4,5	Solve Any 2 out of 3
III	2 Questions to be set of 20 Marks Each	6a,6b	Solve Any 1 out of 2

Program: Biotechnology		
Course Title: Unit Operations-I		Course Code:17EBTF201
L-T-P: 3-0-0	Credits: 3.0	Contact Hours: 3 hours/week
ISA Marks:50	ESA Marks:50	Total Marks:100
Teaching Hours:40	Examination Duration:3 hrs	
Unit I		
1. Basics of mass transfer		
Introduction to Mass Transfer, Classification of mass transfer operations, Diffusion, Fick's law of diffusion, Vapour Liquid Equilibrium (T_{xy} & xy plots), Raoult's law, Relative volatility and its importance. Prediction of VLE data for binary mixture (Ideal system).		
05 Hours		
2. Distillation		
Types of distillation: simple/Batch distillation, Multi stage tray tower distillation, Packed column distillation & steam distillation. Determination of theoretical stages in multistage tray tower distillation column: Construction of equilibrium curve, Equations for operating lines of rectifying section & stripping section, Equation for feed line (q-line). Concept of Reflux ratio, Types of Refluxes: Total reflux, Minimum reflux & Optimum reflux. Conceptual numerical Problems on determination of number of theoretical stages.		
10 Hours		

Unit II

3. Drying & Crystillation:

Importance of Drying, Terminologies and definitions, Drying rate curves under constant drying conditions, Drying Equipments: Tray dryer, Freeze dryer/Lyophilizer, spray dryer etc. *Crystallization*: Concept of Crystallation, Principle and Applications

05 Hours

4. Extraction

Introduction, Liquid-Liquid & Solid-Liquid Extraction Principles, selection of solvents. Batch and Continuous Extraction. Extraction Processes: Aqueous two phase Extraction, Super critical Fluid extraction.

04 Hours

5. Adsorption

Concept of Adsorption, Types of Adsorption, Adsorption Isotherms, Applications of Adsorption in Chromatography.

03 Hours

6. Heat transfer

Heat transfer: Introduction, Modes of heat transfer: conduction, convection and radiation. Conduction: Fourier's law of heat conduction, Thermal conductivity. Steady state heat conduction through unilayer and multilayer plain wall, Unilayer & multilayer Cylindrical pipe. Conceptual problems.

04 Hours

Unit III

7. Convective heat transfer & Heat transfer equipment's

Forced and natural convection, individual and overall heat transfer coefficient, Correlation for h and U for the flow in circular tubes and annulus. Calculation of h (film heat transfer coefficient) based on dimensionless number, Concept of Log Mean Temperature Difference (LMTD). Typical heat transfer equipments: Double pipe heat exchanger, Shell and tube heat exchanger. (Line diagram and operation).

05 Hours

8. Condensation & Boiling

Condensation: Drop wise & Film wise condensation. Boiling: Phenomenon, different regimes of Boiling (descriptive only). Insulation, Critical thickness of Insulation.

05 Hours

Text Books

1. McCabe W. L. and Smith J. C, Unit operations of chemical engineering, 7th, McGraw-Hill, 2005
2. C. J. Geankoplis, Transport Processes and unit operations, 4th, Prentice Hall of India, 2004

Reference Books

1. George Granger Brown, Unit Operations, 1st, CBS Publishers & Distributors, 2004
2. Alan S Foust, Principles of Unit operations, 2nd, John Wiley & Sons, 1980

Scheme for End Semester Assessment (ESA)

UNIT	8 Questions to be set of 20 Marks Each	Chapter numbers	Instructions
I	3 Questions to be set of 20 Marks Each	1, 2,	Solve Any 2 out of 3
II	3 Questions to be set of 20 Marks Each	3,4,5,6	Solve Any 2 out of 3
III	2 Questions to be set of 20 Marks Each	7,8	Solve Any 1 out of 2

Program: Biotechnology		
Course Title: Microbiology Lab		Course Code: 15EBTP201
L-T-P: 0-0-1	Credits:1.0	Contact Hours: 2Hrs/week
ISA Marks: 80	ESA Marks: 20	Total Marks: 100
Teaching Hours: 24	Examination Duration: 03 Hours	

List of Experiments:

1. Laboratory safety precautions, material safety guidelines, cleaning & storage practices, culture disposal practices.
 2. Study of Laboratory equipments: Microscope, Autoclave, Laminar Air Flow Bench, Hot Air Oven, Bacteriological Incubator and Freeze Drier. SOP and Calibration.
 3. Media preparation: Nutrient broth/Agar, Mac-Conkey's medium and Potato-Dextrose broth/Agar.
 4. Micrometry: Bacterial Cell measurement
 5. Pure culture techniques: Streak plate Method, Spread plate Method, Pour plate Method.
 6. Isolation and enumeration of microorganisms from environmental sources. (Open-ended experiment)
 7. Simple and Differential Staining Techniques (Gram staining technique).
 8. Hanging drop technique for motility and Endospore staining.
 9. Study of bacterial growth curve (difference between non spore former and spore former)
- Sterilization by Filtration and antibiotic susceptibility testing.

Text Books/Reference Books:

1. Microbiology: A Lab Manual Seventh Edition by Cappuccino J G and Sherman N 2012 Pearson education Inc, 2012 (ISBN 978-81-317-1437-9).
2. Laboratory experiments in Microbiology, Ninth Edition by Ted R. Johnson and Christine Case. Pearson Education (ISBN 978-0-321-56028-5)
3. Techniques in Microbiology: A Student Handbook by John M. Lammert. Pearson Education (ISBN 978-0-13-224011-6)

Program: Biotechnology		
Course Title: Biochemistry Lab		Course Code: 15EBTP202
L-T-P: 0-0-1	Credits:1.0	Contact Hours: 02 Hours/week
ISA Marks: 80	ESA Marks: 20	Total Marks:100

Teaching Hours: 24	Examination Duration: 03 Hours	
List of Experiments		
<ol style="list-style-type: none"> 1. Biochemical Measurements: Molarity, Normality, Molality, Moles, weight/volume measurements, percent solution, concentration Units. pH measurements and Buffer preparation, SOP's, Instrument calibrations. 2. Qualitative analysis of carbohydrates and Lipids 3. Qualitative analysis of amino acids and proteins. 4. Estimation of Reducing sugar by Folin – Wu method. 5. Estimation of Reducing sugar by Nelson –Somogyi/DNS method. 6. Estimation of Amino acids by ninhydrin method. 7. Estimation of Proteins by Lowry's method. 8. Estimation of Inorganic Phosphate by Fiske-Subbarao method. 9. Estimation of Urea by DAMO method 10. Estimation of DNA by Diphenylamine method. 11. Estimation of RNA by Orcinol method. 		
Text Books/ Reference Books		
<ol style="list-style-type: none"> 1. David Plummer An introduction to Practical biochemistry. Third edition, McGraw-Hill, 1987. 2. Sadasivam S and Manickam A., Biochemical methods. Second edition, New Age International, 2005. 		

Program: Biotechnology		
Course Title: Unit Operations-I Lab		Course Code: 17EBTP201
L-T-P : 0-0-1	Credits: 1.0	Contact Hours: 02 Hours/Week
ISA Marks: 80	ESA Marks: 20	Total Marks: 100

Teaching Hours: 24	Examination Duration: 03Hours	
List of Experiments: <ol style="list-style-type: none">1. Diffusivity measurements2. Drying characteristics.3. Liquid Extraction4. Convective mass transfer5. Simple distillation6. Steam distillation7. Heat transfer in packed bed8. Vertical condenser9. Adsorption studies10. Leaching		
Text books/ Reference books <ol style="list-style-type: none">1. McCabe W. L. and Smith J. C, Unit operations of chemical engineering, 7th, McGraw-Hill, 20052. C. J. Geankoplis, Transport Processes and unit operations, 4th, Prentice Hall of India, 2004		

1.1.3. Number of courses having focus on employability/ entrepreneurship/ skill development during the year.

**Year of offering: 2021-22
Batch- 2020-24 (4th semester)**

IV Semester

Program: Biotechnology		
Course Title: Biostatistics		Course Code: 20EMAB210
L-T-P: 3-1-0	Credits: 4.0	Contact Hours: 03 Hours/Week
ISA Marks: 50	ESA Marks: 50	Total Marks: 100
Teaching Hours: 40	Examination Duration: 03 Hours	
Unit I		
1. Bivariate Distribution Fitting of curves		
Introduction to biostatistics, Review of Central tendency and Dispersion, Correlation, linear regression, Curve fitting (Nonlinear and Exponential curves) 05 Hours		
2. Probability		
Definition of probability, addition rule, conditional probability, multiplication rule, Baye's rule, sensitivity, specificity, predictive value positive and negative, Probability in Genetics: Punnett square, Hardy - Weinberg law, Wahlund's Principle 05 Hours		
3. Probability distributions		
Discrete probability distributions - Binomial, Poisson, Continuous Probability Distribution – Normal, Exponential, Gamma distribution 05 Hours		
Unit II		
4. Sampling and Statistical Inference		
Introduction, Sampling, Sampling distribution, sample size determination, Confidence intervals, Tests of hypothesis, p-value, t-test for single mean, difference of mean (with equal variance and unequal variance), paired t-test, Chi Square test for goodness of fit and independence of attributes, analysis of variance (one-way and two-way classifications). Case studies of statistical designs of biological experiments (RCBD, RBD) 08 Hours		
5. Design of Experiments-1		
Introduction, OFAT, 2 ² and 2 ³ factorial experiments: Data table, Graphical representation, Main and interaction effects, ANOVA Table 07 Hours		

Unit III

6. Design of Experiments -2

Fractional factorial design, Plackett-Burman design, Response Surface Methods-Central Composite Design

05 Hours

7. Population Growth Models

Introduction, Discrete time and continuous growth, Density Independent growth model: Geometric and Exponential growth model, Density dependent growth: Logistic growth model

05 Hours

Text Books:

1. Applied Statistics and Probability for Engineers, Douglas Montgomery, George Runger, 6Ed, John Wiley, 2014
2. Introduction to Probability and Statistics: Principles and Applications for Engineering and Computing, J. Susan Milton, Jesse C Arnold, 4, TATA Mc-Graw Hill Edition, 2007
3. Mathematical Models in Biology and Medicine, Kapoor J.N, EWP New Delhi, 2000

Reference Books:

1. Fundamentals of Mathematical Statistics, Gupta S.C and Kapoor V.K, 11Ed, Sultan Chand & Sons, New Delhi, 2002

Scheme for End Semester Assessment (ESA)

UNIT	8 Questions to be set of 20 Marks Each	Chapter numbers	Instructions
I	3 Questions to be set of 20 Marks Each	1, 2, 3	Solve Any 2 out of 3
II	3 Questions to be set of 20 Marks Each	4, 5	Solve Any 2 out of 3
III	2 Questions to be set of 20 Marks Each	6,7	Solve Any 1 out of 2

Program: Biotechnology		
Course Title: Immunology		Course Code: 15EBTC203
L-T-P: 3-0-0	Credits: 03	Contact Hours:
ISA Marks: 50	ESA Marks: 50	Total Marks: 100
Teaching Hours: 40	Examination Duration: 03 hours	
Unit I		
1. Immune system		
History and Scope of Immunology and Immune system, Classification of Immune system, Types of Immune responses, Molecules ,Cells and Organs of Immune system and Anatomy of immune response.		
06 hours		
2. Humoral Immunity		
Overview of Humoral immunity, B- Lymphocytes – Development and their activation, Antibody response, Structure and functions of Immunoglobulins, Classes and sub-classes of immunoglobulins, genetic control of antibody production, Monoclonal and Polyclonal antibodies, Production of Monoclonal antibodies and quality screening processes in large scale monoclonal antibody production		
05 hours		
3. Cell Mediated Immunity		
Overview of cell mediated immunity and its significance, T-Lymphocytes – Development, Types and their activation, Major Histocompatibility (MHC) Complex, Antigen Presenting Cells (APC) and antigen processing and presentation, Mechanism of Phagocytosis- Oxygen dependent and Oxygen independent.		
04 hours		

Unit II

4. Regulation of Immune Response and Immune tolerance

Immune response – Nature and necessity of its regulation, Complement System- Types, activation and types and their biological applications, Cytokines – types and their role in immune response, Immune Tolerance and their types, Hypersensitivity reactions – Types and Treatments. **Food allergy**, Case study on mechanism of immunity booster.

05 hours

5. Immunological disorders

Auto immune disorders – Features, important types and Experimental models of auto immune diseases Immunodeficiency Disorders – Types and features.

04 hours

6. Transplantation immunology

Transplantation antigens – Types and functions, Types of Transplantations, Immunological basis of Graft rejection , and their disease association, Role of HLA in graft rejection, Tumor specific antigens, Tissue typing, Immune suppression and immune suppressive drugs.

06 hours

Unit III

7. Molecular Immunology

Vaccines – Types and their development, Production of Recombinant DNA vaccines, Application of PCR technology to produce antibodies, Immune Therapy with genetically engineered antibodies, Catalytic antibodies, immunotherapeutic applications of hematopoietic stem cells, Purification and preparation of antigens in vaccine development and Immunoinformatics.

06 hours

8. Immunodiagnosis

Immunization and Antiserum, Antigen-Antibody interactions – Precipitation reactions and Agglutination reactions Immuno-electrophoresis and Immunofluorescence assay, Principle and applications of ELISA and RIA and Western blotting analysis.

04 hours

Text Books

1. Janis. Kuby, Immunology, V, WH Freeman and Company, 2003
2. Pandian and Senthil Kumar, Immunology and Immunotechnology , Panima Publishing Corporation, 2007

Reference Books

1. P.M. Ladyard, Immunology , Bios Scientific Publishers Ltd , 2000
2. Roitt I, Essential Immunology, Blackwell Scientific Publications.

Scheme for End Semester Assessment (ESA)

UNIT	8 Questions to be set of 20 Marks Each	Chapter numbers	Instructions
I	3 Questions to be set of 20 Marks Each	1, 2, 3	Solve Any 2 out of 3
II	3 Questions to be set of 20 Marks Each	4, 5,6	Solve Any 2 out of 3
III	2 Questions to be set of 20 Marks Each	7,8	Solve Any 1 out of 2

Program: Biotechnology		
Course Title: Enzyme Technology		Course Code: 17EBTC201
L-T-P: 4-0-0	Credits: 4.0	Contact Hours: 04 Hours/Week
ISA Marks: 50	ESA Marks: 50	Total Marks: 100
Teaching Hours: 50	Examination Duration: 03 Hours	

Unit I

1. Introduction to enzymes

History, nomenclature, classification of enzymes, sources of enzymes, properties of enzyme, Types of specificities, mechanism of enzyme action-Lock and Key model and Induced fit model, Enzyme catalysis -Acid base catalysis, covalent catalysis, metal ion catalysis, Proximity and orientation effects. Mechanism of coenzymes (NAD/NADP, FAD/FADH₂, PLP, Coenzyme A, TPP, Biotin)

07 Hours

2. Purification of enzymes

Objectives and strategies in enzyme purification, choice of source-plant, animal and microbial, purification of intracellular and extracellular enzymes (Comprehensive flow sheet for enzyme purification), methods of homogenization, methods of separation-Enzyme fractionation by precipitation (using Temperature, salt, solvent, pH, etc.), liquid-liquid extraction, ionic exchange, gel chromatography, affinity chromatography and other special purification methods., Methods of characterization of enzymes; Analysis of yield, purity and activity of enzymes. Molecular weight determination-SDS-PAGE, MALDI-TOF

08 Hours

3. Enzymatic techniques

Enzyme assay, Enzyme and isoenzyme measurement methods with examples(fixed incubation and kinetic methods) Methods for investigating the kinetics of Enzyme catalyzed reactions-Initial velocity studies, rapid-reaction techniques, Standardization and optimization methods, stability and activity of enzymes

05 Hours

Unit II

4. Enzyme Kinetics and Enzyme Inhibitions.

Kinetics of single substrate reactions; Derivation of Michaelis -Menten equation, turnover number; K_{cat} value, determination of K_m and V_{max} , Line Weaver Burk plot, Eadie Hofstee plot, Hanes woolf plot, Importance of K_m & V_{max} ; Enzyme inhibitions- reversible, competitive, uncompetitive and non-competitive inhibitions and kinetics, allosteric and irreversible inhibition. Substrate inhibitions, Multi-substrate reactions-ordered mechanisms, random mechanisms, Ping-pong mechanism. Allosteric enzymes and regulation - The Monod - Changeux - Wyman model (MCW) and The Koshland - Nemethy - Filmer (KNF) model, Feedback regulation and covalent regulation.

07 Hours

5. Enzymes Of Medical Importance

Acetylcholinesterase, angiotensin converting enzyme (ACE), ACE Inhibitors, HMG Co A reductase inhibitors, pseudocholesterase, 5'-nucleotidase (5NT), glucose-6-phosphate dehydrogenase (GPD), CK isoforms, immunoreactive trypsinogen (IRT) and chymotrypsin; amylase isoenzymes. Importance of enzymes in diagnostics, Enzyme pattern in diseases like Myocardial infarctions, (SGOT, SGPT & LDH). Isoenzymes (CK, LD, ALP). Enzymes in immunoassay techniques, Therapeutic enzymes.

07 Hours

6. Enzyme Immobilization

Techniques of enzyme immobilization, adsorption - matrix entrapment- encapsulation- cross-linking - covalent binding - examples; whole cell immobilization and their application, kinetics of immobilized enzymes, effect of solute, partition & diffusion on the kinetics of immobilized enzymes, uses of immobilized enzymes, Design of Immobilized Enzyme Reactors- Stirred tank reactors (STR), Continuous Flow Stirred Tank Reactors (CSTR), Packed-bed reactors (PBR), Fluidized-bed Reactors (FBR); Membrane reactor

06 Hours

Unit III

7. Industrial Applications of enzymes:

Enzymes used in detergents, use of proteases in food, leather and wool industries, uses of lactase in dairy industry, methods involved in production of glucose and maltose syrup from starch (using starch hydrolyzing enzymes), Glucose from cellulose, glucose oxidase and catalase in food industry,

05 Hours

8. Enzyme transformation and Enzyme Biosensors

The design and construction of novel enzymes- Enzyme Engineering and site directed mutagenesis, Designer enzymes, synzymes, Biocatalysts from extreme Thermophilic and Hyperthermophilic microorganisms (extremozymes) Elements of biosensors, Design of enzyme electrodes and their applications as biosensors in industry, health care and environment.

05 Hours

Text Books

1. David L. Nelson, Michael M. Cox, Lehninger Principles of Biochemistry. , 6, W.H. Freeman, 2012
2. Trevor Palmer, 2. Enzymes: Biochemistry, Biotechnology and Clinical Chemistry, 1, East-West Press Pvt. Ltd, 2004

References

1. Laurence A. Moran, Raymond S. Ochs, J. David Rawn, and K. Gray Scrimgeour. , Principles of biochemistry., 3, Prentice Hall, 2002
2. Faber, Biotransformation in Organic Chemistry , 4, Springer, 2000
Aehle W, Enzymes in industry- production and applications, 3, Wiley-VCH, 2007
3. Nicholas .C. Price and Lewis Stevens, Fundamentals of Enzymology , 3, Oxford University Press , 1991

Scheme for End Semester Assessment (ESA)

UNIT	8 Questions to be set of 20 Marks Each	Chapter numbers	Instructions
I	3 Questions to be set of 20 Marks Each	1, 2, 3	Solve Any 2 out of 3
II	3 Questions to be set of 20 Marks Each	4,5,6	Solve Any 2 out of 3
III	2 Questions to be set of 20 Marks Each	7,8	Solve Any 1 out of 2

Program: Biotechnology		
Course Title: Cell and Molecular Biology		Course Code:15EBTC205
L-T-P: 4-0-0	Credits: 04	Contact Hours: 04 Hours/Week
ISA Marks: 50	ESA Marks: 50	Total Marks: 100
Teaching Hours: 50	Examination Duration: 03 Hours	

Unit I

1. Cell Biology and Biotechnology

Organization of Prokaryotic and Eukaryotic cells. Structure and functions of membranes, nucleus, endoplasmic reticulum, Golgi complex, mitochondria, chloroplast and vacuoles. Cell division, Cell Cycle regulation and Cancer. Applications of cell biology and its principles in Genetic Engineering and Microbial, Plant & Animal Biotechnology

05 Hours

2. Molecular Biology and Nucleic Acids

Development and scope of Molecular Biology, Central Dogma of Molecular Biology and its updated view, Classical experiments and Nucleic acids as genetic material, Overview of Genome: Viral genome, bacterial genome, Mitochondrial genome, Eukaryotic genome. Organization of Prokaryotic and Eukaryotic genome/Chromosomes. Typical Gene structure in Prokaryotes and Eukaryotes. Structure and forms of nucleic acids, factors determine the structure of DNA. Denaturation and melting curves. Overview of Isolation, Purification, Estimation and Storage of Nucleic acids.

10 Hours

3. Replication of DNA

An overview and Basic rules for DNA Replication, Enzymes and proteins of DNA Replication, DNA Replication is Semi conservative, Origin of DNA Replication, Replicon and Replication fork, Unidirectional and Bidirectional replication of DNA, Mechanism of DNA replication in prokaryotes and in Eukaryotes.

05 Hours

Unit II

4. Transcription

General features of Transcription process, Types of RNA molecules, Prokaryotic and eukaryotic RNA polymerases, Promoter structure and Mechanism of transcription in prokaryotes and eukaryotes, Post transcriptional modifications of mRNA, tRNA and rRNA, Transcription inhibitors

05 Hours

5. Translation

Features of Genetic code and Wobble hypothesis, Overview of protein synthesis, Components required for protein synthesis, Mechanism of protein synthesis in prokaryotes and eukaryotes, Post-translational modifications and Protein targeting, Inhibitors in translation

04 Hours

6. Regulation of Gene Expression in Prokaryotes and Eukaryotes.

Regulation of gene activity, Gene regulation in Prokaryotes: Constitutive, Inducible and repressible gene expression systems, Operon model for gene expression regulation in prokaryotes, Positive and Negative regulation of – Lac Operon – Regulation, Catabolic repression and Gratuitous inducers etc, Trp Operon and Gal Operon. Gene regulation in Eukaryotes, Regulation of Gene expression at Genome level, Transcriptional level –Acetylation of Histones, Chromatin remodeling, DNA Methylation, DNA elements, Transcription factors, Insulators, Regulatory proteins and Hormones. Gene regulation at Post transcriptional level – Splicing, RNA interference, Transport of mRNA and by regulating mRNA stability.

07 Hours

7. Mutations and DNA Repair

Mutation – Source of genetic variability, basic features of Mutation process, Molecular basis of Mutation, Conditional lethal mutations as a powerful tool for genetic studies and Ames test of Mutagenicity testing. DNA damage and different types of DNA repair systems and Human diseases.

04 Hours

Unit III

8. Polymerase Chain Reaction

Principle of polymerase chain reaction (PCR) - Components of PCR reaction and optimization of PCR. Primer design and types of PCR– Inverse PCR, Hot-start PCR, Loop mediated PCR -, Reverse transcription PCR and Real time PCR. Chemistry of primer synthesis.

05 Hours

9. Analysis of Gene Expression

Analyzing Transcription – Northern Blots, RNase protection assay, Reverse Transcription (RT) PCR and Primer extension assay. Transcriptome Analysis – Differential screening and Array based methods. Promoter activity study – Reporter genes and Run-On assays. Translational Analysis – Western Blots and 2-D Analysis.

05 Hours

Text Books

1. Cell and Molecular Biology – S C Rastogi, New Age International Publishers, New Delhi (1996).
2. Fundamentals of Molecular Biology Ane's Student Edition. - Veer Bala Rastogi, Ane Books India, New Delhi (2008)

Reference Books

1. Instant Notes in Molecular Biology – P.C. Turner, Viva Series Publishing, New Delhi
2. Essentials of Molecular Biology – V Malathi, Dorling Kindersley (India) Pvt Ltd, New Delhi (2013).

Scheme for End Semester Assessment (ESA)

UNIT	8 Questions to be set of 20 Marks Each	Chapter numbers	Instructions
I	3 Questions to be set of 20 Marks Each	1, 2, 3	Solve Any 2 out of 3
II	3 Questions to be set of 20 Marks Each	4,5,6,7	Solve Any 2 out of 3
III	2 Questions to be set of 20 Marks Each	8,9	Solve Any 1 out of 2

Program: Biotechnology		
Course Title: Unit Operations-II		Course Code:17EBTF202
L-T-P: 3-0-0	Credits: 3	Contact Hours:40
ISA Marks:50	ESA Marks:50	Total Marks:100
Teaching Hours:40	Examination hours	Duration:3
Unit I		
1. Basic concepts		
Fluid definition, Properties of biological fluids, Classification of biological fluids, Types of fluid flow, Reynolds number, pressure measurement devices: manometers, Bourdon gauge, bellow gauge, capsule gauge, Hydrostatic equilibrium, Newton's law of viscosity.		
04 hours		
2. Fluid dynamics		
Basic equations of fluid flow: Mass balance, Continuity equation, Bernoulli's equation, Laminar Flow through Circular pipe, Velocity and shear stress distribution, Boundary layer, Boundary layer separation, minor loss and major loss.		
05 hours		
3. Flow past immersed bodies		
Drag, lift, Drag coefficient, Kozney- Carman equation, Ergun's Equation. Motion of particles through fluids, Settling, Types of settling, Stoke's law, Newton's law, Criteria for settling regime, Numerical problems.		
06 hours		
Unit II		
4. Transportation and metering of liquids		
Pipe and tube, joints and fittings, valves—Diaphragm/pneumatic valve, pinch valve, ball valve, plug valve. Pumps: peristaltic pumps, sinusoidal pumps, single use diaphragm pumps. Characteristic curves of a pump, Measurement of fluid flow rates, venturimeter, rotameter, pitot tube, vortex-shedding meter, turbine meter, magnetic meters, ultrasonic meters, thermal meters. Numerical problems.		
08 hours		
5. Mechanical separations		
Filtration, Filter media, Filter aids, factors affecting rate of filtration, specific cake resistance, media resistance. Types of filters, Membrane processes—ultra filtration and microfiltration, Filtration equipment: rotary drum filter, leaf filter. Sedimentation, Kynch theory of sedimentation, Thickener, Numerical problems.		
07 hours		

Unit III

6. Mixing and agitation of liquids

Mixing and Agitation, Flow patterns in agitated tanks, Mechanism of mixing, Estimation of mixing time, Types of Impellers & propellers, Standard turbine design, Numerical problems.

05 hours

7. Dimensional Analysis and similitude

Units and dimensions, Dimensionless number, Rayleigh and Buckingham π theorem. Model and prototype. Similitude. Problems on Rayleigh and Buckingham π theorem.

05 hours

Text Books

1. Unit operations of chemical engineering by McCabe W. L., Smith J. C, and Peter Harriott, 7th edition, McGraw-Hill, 2005.
2. Transport Processes and Separation Process Principles by C. J. Geankoplis, 4th edition, Prentice Hall of India, 2004.

Reference Books

1. Fluid Mechanics by John F. Douglas, Janusz M. Gasiorek, John A. Swaffield, 4th edition, Pearson Education limited 2007.
2. Principles of Unit operations by Alan S Foust, 2nd edition, John Wiley & Sons, 2005.
3. Engineering Fluid Mechanics by K. L. Kumar, 7th edition, Eurasia Publishing house (P) Ltd, 2007.

Scheme for End Semester Assessment (ESA)

UNIT	8 Questions to be set of 20 Marks Each	Chapter numbers	Instructions
I	3 Questions to be set of 20 Marks Each	1, 2,3	Solve Any 2 out of 3
II	3 Questions to be set of 20 Marks Each	4,5	Solve Any 2 out of 3
III	2 Questions to be set of 20 Marks Each	6,7	Solve Any 1 out of 2

Program: Biotechnology		
Course Title: Enzyme Technology Lab		Course Code: 15EBTP204
L-T-P: 0-0-1	Credits:1.0	Contact Hours: 02 Hours/week
ISA Marks:80	ESA Marks: 20	Total Marks:100
Teaching Hours: 24	Examination Duration: 03 Hours	
List of Experiments		
<ol style="list-style-type: none"> 1. Biochemical Measurements: Molarity, Normality, Molality, Moles, weight/volume measurements, percent solution, concentration Units. pH measurements and Buffer preparation, SOP's, Instrument calibrations. 2. Determination of activity of amylase enzyme 3. Estimation of protein content of amylase and specific activity 4. Effect of temperature on enzyme activity 5. Effect of pH on enzyme activity 6. Effect of substrate concentration on enzyme activity 7. Effect of enzyme concentration on enzyme activity 8. Effect of inhibitor on enzyme activity 9. Enzyme immobilization and kinetics of immobilized enzyme 10. Molecular weight determination by SDS PAGE 11. Staining the gel using CBB and silver staining 		
Text Books/ Reference Books		
<ol style="list-style-type: none"> 1. Introduction to Practical biochemistry – David Plummer, McGraw-Hill Publishing Co, 3rd edition, pp:332. 2. Biochemical methods- Sadasivam and Manickam(1996), New Age International Publishers, 2nd edition, pp256. 3. Experimental Biochemistry – A Student Companion by Beedu Shashidhar Rao and Vijay Deshpande.(2005) I.K International Pvt. Ltd, New Delhi. pp301 		

Program: Biotechnology		
Course Title: Cell and Molecular Biology Lab		Course Code: 15EBTP205
L-T-P: 0-0-1	Credits: 1.0	Contact Hours: 02 Hours/Week
ISA Marks: 80	ESA Marks: 20	Total Marks: 100
Teaching Hours: 24	Examination Duration: 03 Hours	
List of Experiments		
<ol style="list-style-type: none"> 1. Basic Calculations and Solutions preparation skills and Good Lab Practices(GLPs)for the Molecular biology lab 2. Study SOPs of Cell and Molecular Biology laboratory equipments – Table top cooling Centrifuge, UV – Visible Spectrophotometer, PCR machine and Gel Documentation system. 3. Staining and microscopic observation of plant/animal cellsand chromosomes 4. Study of Mitosis and Meiosis Cell Divisions 5. Isolation of genomic DNA from Bacteria/ Plant/ Animal cells 6. UV Spectrophotometric analysis of DNA and RNA 7. Calculation of T_m value of isolated DNA sample 8. Agarose gel electrophoresis and gel elution method. 9. Isolation and agarose gel electrophoresis estimation of Plasmid DNA 10. Extraction of Total RNA from different biological sources 		
Text Books /Reference Books		
<ol style="list-style-type: none"> 1. Cell and Molecular Biology – A Lab Manual K V Chaitanya PHI Learning Private Limited Delhi – 110092, 2013. 2. Molecular Cloning Volumes I, II and III – Sambrook J <i>et al</i> (2000) Cold Spring Harbour Laboratory Press, 2000 		

Program: Biotechnology		
Course Title: Unit Operations-II Lab		Course Code:17EBTP202
L-T-P: 0-0-1	Credits: 1	Contact Hours: 02 Hours/Week
ISA Marks:80	ESA Marks:20	Total Marks:100
Teaching Hours:	Examination hours	Duration:3
<p>List of Experiments:</p> <ol style="list-style-type: none"> 1. Pressure drop correlations through packed bed. 2. Studies on sedimentation. 3. Studies on agitation and mixing 4. Constant pressure filtration using leaf filter 5. Pressure drop correlations through circular pipes 6. Study of fluid flow patterns 7. Terminal settling velocity 8. Studies on Bernoulli's equation 9. Studies on flowmeter 		
<p>Text Books/Reference Books</p> <ol style="list-style-type: none"> 1. Unit operations of chemical engineering by McCabe W. L., Smith J. C, and Peter Harriott, 7th edition, McGraw-Hill, 2005. 2. Transport Processes and Separation Process Principles by C. J. Geankoplis, 4th edition, Prentice Hall of India, 2004. 		

1.1.3. Number of courses having focus on employability/ entrepreneurship/ skill development during the year.

Year of offering: 2021-22

Batch- 2019-23 (5th semester)

Program: Biotechnology		
Course Title: Genetic Engineering and Applications		Course Code: 15EBTC301
L-T-P: 4-0-0	Credits: 4.0	Contact Hours: 04 Hours/Week
ISA Marks: 50	ESA Marks: 50	Total Marks: 100
Teaching Hours: 50	Examination Duration: 03 Hours	
Unit I		
1. Basics of Recombinant DNA technology		
Development and Scope of Recombinant DNA Technology and Genetic Engineering. Emergence and commercialization of Molecular Biotechnology. Ethical, Social, Economical and Political issues related to Gene modification and Genetic Engineering. Gene Cloning: Introduction and Steps involved in gene cloning. Subcloning and its applications. Vectors in GE - biology, features, types, cloning & expression vectors		
06 Hours		
2. Enzymes in Genetic Engineering		
DNA modifying enzymes and necessity of DNA modification in gene cloning. Enzymes used for DNA modification. Restriction Endonucleases, classification & mode of action, Role and applications of different DNA modifying enzymes in gene cloning process - DNA Polymerases, Reverse Transcriptase, RNA Polymerase, Alkaline Phosphatases, Polynucleotide Kinase and DNA Ligases etc.		
05 Hours		
3. Molecular Cloning Strategies and Genetic Transformation		
Isolation and purification of nucleic acid (genomic/plasmid DNA and RNA), Quantification on and storage of nucleic acids, Construction of cDNA library, Construction of Genomic library, Screening and preservation of DNA libraries. DNA Cloning – Methods and applications. Genetic Transformation of prokaryotes and DNA Transfection in Eukaryotic hosts. Biological and Non-biological methods of gene transfer in hosts. Chloroplast transformation.		
09 Hours		
Unit II		
4. Selection, Screening and Analysis of Recombinants		
Introduction to screening and analysis of recombinants. Genetic selection and screening methods - Selectable Marker genes, Reporter genes. Screening using Nucleic acid hybridization methods - Preparation of probes for hybridization experiments and different blotting techniques. Screening by PCR based methods. Screening by Immunological methods and Analysis of cloned genes.		
07 Hours		

5. Production of Proteins from Cloned Genes

Introduction to recombinant gene expression, scope and applications of recombinant gene expression. Special vectors for expression of foreign genes in E coli. General problems with the production of recombinant protein in E coli. Production of recombinant proteins by Eukaryotic cells.

07 Hours

6. Directed Mutagenesis and Protein Engineering

Oligonucleotide – Directed Mutagenesis with M13 DNA, Plasmid DNA, PCR Amplification etc. Protein Engineering – Meaning and Scope, Protein Engineering for adding disulphide bonds, increasing enzymatic activity, decreasing protease sensitivity, modifying protein specificity, Increasing enzyme stability and specificity etc.

06 Hours

Unit III

7. Genetic Engineering and Microbial Biotechnology

Genetic manipulation of Microorganisms – Introduction and scope. Applications of Recombinant Microorganism – Production of recombinant therapeutic proteins, Production of Antibiotics, Combating Human diseases, Microbial pesticides, EffiISAnt utilization of Carbohydrates and Bioremediation or Environmental cleanup.

05 Hours

8. Plant and Animal Transgenic Technology and Applications

Applications of Transgenic Plant Technology – Development of Insect resistant plants, Herbicide resistant plants, Pathogens resistant plants, and Abiotic stress tolerant plants. Plants as Bioreactors for large scale production. Applications of Animal cloning and Transgenic technology - Cloning in Domestic animals. Applications of Transgenic Animals - as research models, and as bioreactors for large scale production of substances for Human welfare.

05 Hours

Text Books

1. Genetic Engineering by Smitha Rastogi and Neelam Pathak, Oxford University Press, USA (2009)
2. Molecular Biotechnology – Principles and applications of Recombinant DNA by Bernard r Glick and Jack J Pasternak, ASM Press, American SoISAty for Microbiology, Washington DC 2003

Reference Books

1. Gene Cloning and DNA Analysis by T A Brown. Wiley-Blackwell (2010)
2. An Introduction to Genetic Engineering – Third Edn By Desmond S T Nicholl, Cambridge University Press, Singapore 2008.

Scheme for End semester assessment (ESA)

UNIT	8 Questions to be set of 20 Marks Each	Chapter numbers	Instructions
I	3 Questions to be set of 20 Marks Each	1, 2, 3	Solve Any 2 out of 3
II	3 Questions to be set of 20 Marks Each	4,5,6	Solve Any 2 out of 3
III	2 Questions to be set of 20 Marks Each	7,8	Solve Any 1 out of 2

Program: Biotechnology		
Course Title: Bioinformatics		Course Code: 19EBTC301
L-T-P: 4-0-0	Credits: 4.0	Contact Hours: 04 Hours/Week
ISA Marks: 50	ESA Marks: 50	Total Marks: 100
Teaching Hours: 50	Examination Duration: 03 Hours	

Unit - I

1.Database

Introduction, meaning of databases, types of databases, Primary Database: NCBI, Genbank, DDBJ, EMBL. File formats, Secondary Database: PROSITE, PIR, UNIPROT, BLOCKS, Pfam, specialized databases: metabolic pathway database, Structure Database: PDB, MMBD, CATH, SCOP, Ligand Database, Enzyme database, human disease database, microbial and viral genome database, structure visualization tools.

7 Hours

2.Pairwise Sequence Alignment

Meaning and significance of Sequence alignment, Pairwise sequence alignment, Global alignment, Local Alignment, overview of methods, Methods & Algorithms-dot matrix, dynamic programming, substitution matrices, gap penalties, FASTA, BLAST, PSI-BLAST & PHI-BLAST.

8 Hours

3.Multiple Sequence Alignment

Meaning of Multiple Sequence Alignment, Global Multiple Sequence Alignment: Progressive Alignment methods, Iterative methods, Local Multiple sequence Alignment, Significance of Multiple Sequence Alignment, Multiple Sequence Alignment editors. Motifs and Patterns analysis

5 Hours

Unit - II

4.Molecular Phylogenetics

Meaning of phylogenetic analysis, Meaning & significance of evolutionary trees, Rooted and unrooted trees, Elements of phylogenetic Models, Phylogenetic Data Analysis, Distance based methods: Neighbor Joining (NJ) method, Fitch-Margoliash (FM) method, Minimum Evolution (ME) method, Character based methods: Maximum parsimony, Maximum Likelihood; Tree Evaluation methods, Phylogenetic Softwares

7 Hours

5.Gene Prediction

Prokaryote and Eukaryote gene prediction, Prokaryote and Eukaryote promoter site prediction Gene Prediction tools, Genomic database, Next Generation Sequencing.

5 Hours

6.Protein Prediction

Protein structures: Secondary Structure: Alpha helix, beta Sheets, phi & psi angles, Ramachandran plots. Protein Secondary Structure Prediction, Tertiary Structure Predictions:

Homology modeling, Protein analysis software: Physicochemical parameters, binding site, sub-cellular location, protein stability, patterns

8 Hours

Unit - III

7.In-silico Drug Designing-I

Introduction to traditional drug designing, Introduction in-silico drug designing approach, Methodology for in-silico drug designing: Structure based and Fragment based drug designing, Steps in drug designing: Target identification, target validation, lead identification and validation, different tools used for drug designing, molecular Modeling

5 Hours

8.In-silico Drug Designing-II

Identification of ligands, Lipinski's rule, Virtual Screening, Process of Docking, Quantitative structure-activity relationship (QSAR), Physical and Chemical basis of receptor ligand interactions, ADMET property analysis.

5 Hours

Text Books

1. Andreas D. Baxevanis, B. F. Francis Ouellette, Bioinformatics: A Practical Guide to the Analysis of Genes and Proteins, 3rd, Wiley-Inte, 2005
2. David Mount, Bioinformatics: Sequence and Genome Analysis , 2nd, Cold Sprin, 2004

Reference Books

1. P. Rastogi, N. Mendiritta, S. C. Rastogi, Bioinformatics: Methods and Applications: Genomics, Proteomics and Drug Discovery, 4th, Prentice-H, 2013.
2. Anand Solomon K, Molecular Modelling and Drug Design , 1st, MJP Publis, 2015
3. Richard Durbin, Sean R. Eddy, Anders Krogh, Biological Sequence Analysis: Probabilistic Models of Proteins and Nucleic Acids, 1st, Cambridge , 1998

Scheme for End semester assessment (ESA)

UNIT	8 Questions to be set of 20 Marks Each	Chapter numbers	Instructions
I	3 Questions to be set of 20 Marks Each	1, 2, 3	Solve Any 2 out of 3
II	3 Questions to be set of 20 Marks Each	4,5,6	Solve Any 2 out of 3
III	2 Questions to be set of 20 Marks Each	7,8	Solve Any 1 out of 2

Program: Biotechnology

Course Title: Reaction Engineering

Course Code: 15EBTC303

L-T-P: 4-0-0	Credits: 4	Contact Hours: 50
ISA Marks: 50	ESA Marks:100	Total Marks: 100
Teaching Hours: 50	Examination Duration: 3 hrs	
UNIT-I		
<p>1: Introduction Introduction to homogeneous and heterogeneous reaction in ideal reactors. Elementary and elementary reactions kinetics of homogeneous and heterogeneous reaction system.</p> <p style="text-align: right;">06 Hours</p>		
<p>2: Interpretation of Batch Reactor data Introduction to analysis of experimental reactor data, evaluation of rate equation, integral and differential analysis of kinetic data's, constant volume system and variable volume System. Total pressure technique of analyzing the kinetic data of gaseous reaction system.</p> <p style="text-align: right;">08 Hours</p>		
<p>3. Introduction to Bioreactor Design. General discussion on basics bioreactor design. General material balance equation for various conditions. Ideal reactors for a single reaction. Design equations for homogeneous system: batch, stirred tank and tubular flow reactor, size comparison of reactor systems.</p> <p style="text-align: right;">08 Hours</p>		
UNIT-II		
<p>4 Design for Multiple Reactions Introduction, general design approach to multiple reactions. Quantitative and qualitative analysis of product distribution. Effect of temperature and pressure on single reaction. General graphical procedure, optimum temperature progression. Factors affecting choice of reactors: optimum yield, conversion, selectivity and reactivity.</p> <p style="text-align: right;">08 Hours</p>		
<p>5 Non-Ideal Reactors Non-ideal reactors, residence time distribution studies, Stimulus Response Technique, pulse and step input response of reactors, RTD's for CSTR and PFR, Relationship between C, E and F-curve. Kinetic models for non Ideal reaction system, Axial Dispersion Model</p> <p style="text-align: right;">04 hours</p>		
<p>6 Microbial kinetics: Introduction to microbial kinetics, Yield coefficient, Simple kinetic models for microbial growth, transient growth kinetics Factors affecting the kinetics of Monod model; Growth of Filamentous Organisms. kinetic Models for product formation and substrate degradation</p> <p style="text-align: right;">08 Hours</p>		

UNIT-III

7 Heterogeneous Reactor System:

Heterogeneous reactions in Bioprocessing. The rate equation for surface for kinetics, Pore diffusion kinetics with combined with surface kinetics. Porous catalyst particle Performance equation for reactor containing Porous catalyst particles. External and internal mass transfer effects.

04 Hours

8 Reactor Engineering

Bioreactor configurations: Bubble column, airlift reactor, packed bed, fluidized bed, trickle bed,

04 Hours

Text Books

- 1) Chemical Reaction Engineering by Octave and Levenspiel., John Wiley, 3rd Edition, 2006.
- 2) Elements of Chemical Reaction Engineering by Fogler, H.S., Prentice Hall, 1986.

Reference Books

- 1) Bioprocess Engineering Principles by Pouline M Doran Academic Press , 2003
- 2) Biochemical Engineering Fundamentals By Bailey and Ollies McGraw Hill 2nd Edition
- 3) Chemical Reactor Analysis and Design by Forment G F and Bischoff K B. John wiley, 1976
- 4) Chemical engineering By J.F Richardson and J.M Coulson Volume 6

Scheme for End semester assessment (ESA)

UNIT	8 Questions to be set of 20 Marks Each	Chapter numbers	Instructions
I	3 Questions to be set of 20 Marks Each	1, 2, 3	Solve Any 2 out of 3
II	3 Questions to be set of 20 Marks Each	4,5,6	Solve Any 2 out of 3
III	2 Questions to be set of 20 Marks Each	7,8	Solve Any 1 out of 2

Program: Biotechnology		
Course Title: Biological Thermodynamics		Course Code:15EBTC304
L-T-P: 3-0-0	Credits: 3	Contact Hours:40
ISA Marks:50	ESA Marks:50	Total Marks:100
Teaching Hours:40	Examination hours	Duration:3
Unit I		
<p>1. Basic concepts System, Surrounding, State and Properties, Intensive and extensive properties, State and path functions, Heat reservoir, Hess Law, energy and biological world, energy flow transformation, energy conversions, energy, nutritional requirements of living systems, Flow of electrons in organism, energy flow in metabolic process, division of labor in cells, Numerical problems</p> <p style="text-align: right;">06 hours</p>		
<p>2. Basic laws of thermodynamics Zeroth law, First law of Thermodynamics, cyclic process, non-flow process, flow Process, internal energy, Heat capacity, second law of thermodynamics, Concept of entropy, Calculation of entropy changes, Third law of thermodynamics. Numerical problems.</p> <p style="text-align: right;">09 hours</p>		
Unit II		
<p>3. PVT behavior P-V-T Behavior of pure fluid, Processes involving ideal gases, Equation of state for real gases: Vander Waals equation, Redlich-Kwong equation, Peng-Robinson equation, Virial equation. Compressibility charts: Principle of corresponding states, Numerical problems.</p> <p style="text-align: right;">07 hours</p>		
<p>4. Thermodynamic properties of Biological fluids Classification of thermodynamic properties, Work function, Gibbs free energy, Gibbs-Helmholtz equation, ATP Synthesis in cell and Protein Folding, Metabolic reactions in cells. Entropy - heat capacity relationships, Relationships between C_p and C_v, Activity of molecule, Chemical potential, Oxidation-Reduction reaction, Cell Membrane Transportation & Protein Extraction, Osmosis, Nernst equation in membrane transportation, Numerical problems.</p> <p style="text-align: right;">08 hours</p>		

Unit III

5. Statistical Thermodynamics

Boltzmann distribution & partition function, Protein folding and helix-coil transition, Binding equilibria, Oxygen binding to myoglobin & Hemoglobin.

04 hours

6. Reaction Equilibria

Reaction Stoichiometry, Effect of temperature on standard heat of reaction. energy coupling reactions, activation energy, Criteria of chemical reaction equilibrium, Relationship between Equilibrium constant and standard free energy change, Effect of temperature, pH and pressure on equilibrium constants and other factors affecting equilibrium conversion, Numerical problems.

06 hours

Text Books

1. Biological Thermodynamics by Donald T. Haynie, 2nd edition, Cambridge University Press, 2008
2. Introduction to chemical engineering thermodynamics by J.M. Smith, H. C. VanNess, M.M. Abbott, 7th edition, Tata McGraw-Hill, NewDelhi, 2005.

Reference Books

1. Thermodynamics. An engineering approach, by Yunus A. Cengel, Michael A. Boles, 8th edition, McGraw- Hill, 2014.
2. Chemical Engineering Thermodynamics by Y.V.C. Rao. 2nd edition, Universities Press, 1997.
3. Chemical and Process Thermodynamics by B.G.Kyle. 3rd edition, Prentice Hall of India Private limited, 2015.

Scheme for End semester assessment (ESA)

UNIT	8 Questions to be set of 20 Marks Each	Chapter numbers	Instructions
I	3 Questions to be set of 20 Marks Each	1, 2	Solve Any 2 out of 3
II	3 Questions to be set of 20 Marks Each	3,4	Solve Any 2 out of 3
III	2 Questions to be set of 20 Marks Each	5,6	Solve Any 1 out of 2

Program: Biotechnology		
Course Title: Research Methodology		Course Code:15EBTC305
L-T-P: 3-0-0	Credits: 03	Contact Hours: 40
ISA Marks: 50	ESA Marks: 50	Total Marks: 100
Teaching Hours: 40	Examination Duration: 03 hours	
Unit I		
1. Introduction to Research and Research Methodology		
Introduction, Objectives and scope of research, Research methods and Methodology. Types of research – Descriptive vs. Analytical, Applied vs. Fundamental, Quantitative vs. Qualitative, Conceptual vs. Empirical Concept of Translatory research.		
04 Hours		
2. Research Philosophy and Formulation of Research Problem		
Concept of Research Philosophy- (Ontology, Logic, Method and Epistemeology) Formulation of Research Problem- Necessity of defining the research problem and framing the problem statement.		
03 Hours		
3. Sources and Review of Literature		
Introduction and need for Literature Review., Search Procedures and Gap analysis. Sources of Literature - Research articles, review articles, Research communications, Book chapters. Bibliometrics- Citation index, Impact factor, author h-index and i10-index, awareness on predatory journals and its identification, grants and funding agencies for biotechnology research		
08 Hours		
Unit II		
4. Sampling & Data Collection		
Explain sampling and its significance. Describe different methods of sampling.		
03 Hours		
5. Statistical Analysis of Data		
Measures of Central Tendency, Measures of Dispersion and variance, Correlation and Regression Development of hypothesis and testing : Chi- square test, Student's t-test, ANOVA		
07 Hours		
6. Design of Experiments		
Introduction and significance of DOE, Types - Factorial Design, Plackett Burman Design, Central Composite Design, Response Surface Methodology, Design of matrix and analysis, Contour plots and response surface plots, QBD principles, Introduction to Artificial Intelligence and its application in biotechnology		
05 Hours		
Unit III		
7. Environment, Ethics and IPR in Research		
Impacts of Research on Environment, - Ethical issues, ethical committees, Research Generated Intellectual Property Rights- Copy-right & royalty, Patent law, Trade mark, Trade secret, Geographical Indicator, Industrial Design. Concept of Plagiarism		

05 Hours

8. Research Communication

Written Communication- Introduction, Structure and components of scientific reports – Bibliography, referencing and footnotes. Oral Presentation – Developing and delivering presentation

05 Hours

Text Books

- 1.C.R. Kothari and Guarav Garg, Research Methodology, III Edition, New Age International Publisher, New Delhi, 2014
2. N. Gurumani, Research Methodology for Biological SISAnces, I Edition, MJP Publishers, Chennai, 2007

Reference Books

1. Design and Analysis of Experiments by Montgomery D. C. John Wiley Publishers
2. An Introduction to Research Methodology by Garg, B.L., Karadia, R., Agarwal, F. and Agarwal, U.K. RBSA Publishers

Scheme for End semester assessment (ESA)

UNIT	8 Questions to be set of 20 Marks Each	Chapter numbers	Instructions
I	3 Questions to be set of 20 Marks Each	1, 2, 3	Solve Any 2 out of 3
II	3 Questions to be set of 20 Marks Each	4,5,6	Solve Any 2 out of 3
III	2 Questions to be set of 20 Marks Each	7,8	Solve Any 1 out of 2

Program: Biotechnology		
Lab Title: Mini project		Lab Code:15EBTW301
L-T-P: 0-0-3	Credits: 03	Contact Hours: 9 hrs/week
ISA Marks: 50	ESA Marks: 50	Total Marks: 100
Teaching Hours: 9 hrs/week	Examination Duration: 03 hours	

Guidelines:

- Mini project to be carried out in a group of maximum 4 students.
- Every student needs to maintain laboratory work book which should contain the details of all the work carried out in the laboratory.
- Entries to be done in log books for instrument usage.
- Timely report submission to the coordinator.
- Requisitions for chemicals and glassware's to be provided in advance for the project work

Review committee:

- Review committee is formed by the project coordinator taking into consideration that review committee consists of faculty experts from all domains. Review committee consists of the guide of the respective project group also.

Reviews:

- Continuous internal evaluation will be done by the respective guides/review committee as per the rubrics.
- Total of 3 reviews per semester will be carried out to evaluate the progress of the project.
- During review-1 students have to submit a report duly signed by guide.
- Final evaluation will be done by examiners during semester end examination as per the ESA evaluation scheme.

Phases of mini project:

Sl. No	Phases	Reviewed	Activities
1	Review-1	By Review committee	Need analysis, Detail Review of literature, Objectives, Overall plan of work.
2	Review-2	By Project Guide	Development of protocols, Standardization and screening. Design of experiments, Conduct of experiments, Initial experimental data.
3	Review-3	By Review committee	Final experimentation, Data interpretation and analysis, Conclusion.

Program: Biotechnology		
Course Title: Genetic Engineering & Immunotechnology Lab		Course Code: 15EBTP301
L-T-P: 0-0-1	Credits:1.0	Contact Hours: 2Hrs/week
ISA Marks: 80	ESA Marks: 20	Total Marks: 100
Teaching Hours: 24	Examination Duration: 03 Hours	
<p>List of Experiments:</p> <ol style="list-style-type: none"> 1. Preparation of Competent <i>E coli</i> cells (Structured Inquiry) 2. Ligation of DNA fragment with vector and Transformation (Demonstration) 3. Restriction digestion analysis of plasmid DNA (Structured Inquiry) 4. Introduction to PCR –Programming, and amplification of DNA (Exercise) 5. Screening of Transformants by Colony PCR (Demonstration) 6. TA Cloning method for cloning of PCR product. (Structured Inquiry) 7. Demonstration of Southern blotting (Demonstration) 8. Agglutination techniques – Heam agglutination techniques and Bacterial agglutination techniques (Exercise) 9. Radial diffusion and Rocket Immunoelectrophoresis (Exercise) <p>Dot-ELISA(Enzyme Linked Immuno Sorbent Assay) (Exercise)</p>		
<p>Text Books/Reference Books</p> <ol style="list-style-type: none"> 1.Principles of Gene Manipulations- Introduction to Genetic Engineering, by R.W. Old and S.D. Primrose(2007), Blackwell SISAntific Publications. 2. Molecular Cloning- By T.Maniatis, E.F. Fritsch and J. Sambrook, Cold spring Harbour (2009) 		

Program: Biotechnology		
Course Title: Bioinformatics Lab		Course Code: 15EBTP302
L-T-P: 0-0-1	Credits:1.0	Contact Hours: 2Hrs/week
ISA Marks: 80	ESA Marks: 20	Total Marks: 100
Teaching Hours: 24	Examination Duration: 03 Hours	
<p>List of Experiments:</p> <ol style="list-style-type: none"> 1. Searching bibliographic database for relevant information and retrieve from nucleic acid and Protein sequence database 2. PDB: Protein Data Bank and structure visualization 3. Searching sequence database using BLAST algorithm & Pair wise alignment of the sequences 4. Multiple Sequence Alignment & Phylogenetic Analysis: CLUSTALW/Phylogeny 5. Gene structure Prediction 6. Protein Secondary Structure Prediction 7. Protein Tertiary Structure Prediction 8. Protein Sequence analysis: Physicochemical parameters, binding site, sub-cellular location, protein stability, patterns and conserve domain. 9. Identification of ligands/Virtual Screening 10. Molecular Docking and interaction analysis 11. Define gene structure and design primers specific to the identified gene of microorganisms and draw restriction digestion map for sequence identified 		
<p>Text Books/Reference Books</p> <ol style="list-style-type: none"> 1. Andreas D. Baxevanis, B. F. Francis Ouellette, Bioinformatics: A Practical Guide to the Analysis of Genes and Proteins, 3rd, Wiley-Inte, 2005 2. David Mount, Bioinformatics: Sequence and Genome Analysis , 2nd, Cold Sprin, 2004 		

1.1.3. Number of courses having focus on employability/ entrepreneurship/ skill development during the year.

Year of offering: 2021-22
Batch- 2019-23 (6th semester)

Program: Biotechnology		
Course Title: Bioprocess Engineering		Course Code:15EBTC306
L-T-P: 4-0-0	Credits: 4	Contact Hours: 4 hours/week
ISA Marks:50	ESA Marks:50	Total Marks:100
Teaching Hours:50	Examination Duration:3 hrs	
Unit - 1		
1.Media and Inoculum development for industrial fermentations		
Bioprocess development: An interdisciplinary challenge, Biotechnology & Bioprocess Engineering, steps in bioprocess development, Media ingredients, medium formulation, oxygen requirements, antifoams, medium optimization, Ingredients for mammalian cell culture and plant cell culture. Introduction, Criteria for transfer of inoculum, development of inocula for bacterial processes, yeast processes and mycelial processes. Inoculum development for plant Fermenter.		
8 Hours		
2.Sterilization		
Media sterilization, Design of sterilization process: Batch Process (Dell factor, holding time, and thermal death kinetics), continuous sterilization process; sterilization of fermenter and other ancillaries. Scale up of sterilization, filter sterilization of air and media.		
5 Hours		
3.Design of bioreactors		
Basic objective of fermenter design, aseptic operation & containment regulation, achievement and maintenance of aseptic conditions, body construction, agitator and sparger design, baffles, stirrer glands and bearings. Animal cell bioreactors.		
7 Hours		
Unit - II		
4.Scale Up of Bioreactor		
Scale up of bioreactors: Introduction, Scale-Up methods: Geometric and Dynamic Similarity, Criteria for scale-up: Constant power consumption/volume, constant KLa, constant mixing time, constant tip speed, Regime analysis: Time constant for transport phenomena, time constant for conversion. Scale down approach.		
5 Hours		
5.Heat Transfer		
Heat transfer in Bioprocess: Design equation for heat transfer process, Energy balance, Logarithmic and arithmetic mean temperature difference, Calculation for heat transfer coeffilSAnt, applications of design equations, Relationship in between heat transfer, cell		

concentrations and stirring conditions, Numerical based examples on above. **4 Hours**

6. Mass Transfer

Mass transfer in Bioprocess: Role of diffusion in bioprocessing, Different equations in mass transfer (liquid-solid, liquid-liquid and gas-liquid) , Oxygen uptake in cell culture: Factors affecting cellular oxygen demand, Oxygen transfer from gas bubble to cells, Oxygen transfer in fermenter, measuring dissolved oxygen concentrations, Measurement of KLa: Oxygen balance method, Gassing out techniques (static method of Gassing out and dynamic method of Gassing out) Sulphite oxidation, Factors affecting KLa, Oxygen transfer in large vessels, Numerical based examples on above.

5 Hours

7. Fermenter fluid rheology

Fermentation broth: Viscosity, Viscosity measurement, Rheological properties of fermentation broths, Factors affecting broth viscosity , Mixing in Fermenters: Mechanism of mixing, Assessing mixing effectiveness, estimation of mixing time, Power requirement for mixing: Ungassed Newtonian fluids, un-gassed non-Newtonian fluids, Gassed fluids, Calculation of power requirements, Scaleup of mixing systems, Improving mixing in Fermenters, Effect of rheological properties on mixing, Role of shear in stirred fermenters: Interaction between cells and turbulent eddies, Bubble shear, operating conditions for shear damage. Numericals

6 Hours

Unit - III

8. Bioreactor kinetics

Batch reactor kinetics, CSTR kinetics, Fedbatch kinetics and plug flow kinetics, Numericals

5 Hours

9. Solid State fermentation:

Introduction, SSF v/s SMF, Types of SSF reactors, Microbial growth kinetics in SSF, Heat & Mass Transfer in SSF

5 Hours

Text Books

1. Pauline M. Doran, Bioprocess Engineering Principles, 2, Academic Press, 2003
2. Stanbury & Whittaker, Principles of Fermentation Technology, 2, Pergamum Press, 2000

Reference Books

1. Michael L. Shuler & Fikret Kargi, Bioprocess Engineering, 2, Prentice Hall, 2001
2. Bailey, James E.; Ollis, David F., Biochemical Engineering Fundamentals, McGraw-Hill Education, 1986

Scheme for End semester assessment (ESA)

UNIT	8 Questions to be set of 20 Marks Each	Chapter numbers	Instructions
I	3 Questions to be set of 20 Marks Each	1, 2, 3	Solve Any 2 out of 3
II	3 Questions to be set of 20 Marks Each	4,5,6,7	Solve Any 2 out of 3

III	2 Questions to be set of 20 Marks Each	8,9	Solve Any 1 out of 2
-----	--	-----	----------------------

Program: Biotechnology		
Course Title: Bioprocess Control and Automation		Course Code:19EBTC302
L-T-P: 4-0-0	Credits: 4.0	Contact Hours: 4 hours/week
ISA Marks:50	ESA Marks:50	Total Marks:100
Teaching Hours:50	Examination Duration:3 hrs	
Unit I		
<p>1 Instrumentation & Process Dynamics: Introduction to Measurement of important physicochemical and biochemical parameters in bioprocess. Methods of on line and off line estimation of biomass, substrates and products. Brief introduction to typical automatic control system and its components. Open loop and closed loop control systems.</p> <p style="text-align: right;">05 Hours</p>		
<p>2 First & Second Order Systems: Mathematical representation of physical systems. Transfer function representation of linear first order systems, Examples: mercury in glass thermometer & Liquid level system. Mathematical forms of standard Input function/Forcing Functions such as Step input, Impulse Input, Linearly increasing Input and Sinusoidal Input. Response of first order system for step input, Features of step response, Response of linearly increasing input. Conceptual numerical. First Order Systems in Series: Interacting and Non-Interacting systems & their Transfer function representation. Second Order Systems: Transfer function representation of Second order systems, Example: Pneumatic Control Valve.</p> <p style="text-align: right;">10 Hours</p>		
Unit II		
<p>3 Controller and Final Control Elements: Different types of controllers-P (Special case of P-controller i.e ON-OFF controller), PI, PD, PID controllers. Derivation of Transfer Functions of different types of controllers. Final control element: The role of Final control Element in control system. Example: Pneumatic Control Valve: Working of Pneumatic control valve, Types of Pneumatic Control Valves i.e. Air to close & air to open.</p> <p style="text-align: right;">10 Hours</p>		
<p>4 Block Diagram Reduction: Block diagram representation of control systems, Block diagram reduction in case of Servo and Regulatory control systems. Reduction of block diagrams for single input & Single output systems (SISO) & Multiple Input & Multiple Output Systems (MIMO), Problems on block diagram reduction.</p> <p style="text-align: right;">05 Hours</p>		
<p>5 Block Diagram Reduction (MIMO systems): Analysis of Multiple Input Multiple Output Systems: Introduction to Multiple Input & Multiple Output Systems (MIMO), Examples of MIMO systems. Analysis of MIMO systems considering only one Input at a time while other Inputs are Suppressed. Considering only one output at a time while other outputs are Suppressed. Problems on block diagram reduction considering MIMO systems.</p> <p style="text-align: right;">10 hours</p>		
Unit III		
<p>6 Transient response of different controllers for Servo & Regulatory control Problems: Transient response of P, PI, PD & PID controllers for servo and regulatory problems. The</p>		

determination of offset in all cases.

05 Hours

7 Analysis of Stability: Concept of stability, stability criterion. Routh test for stability. Theorems of Routh Array test, Conceptual numerical on Routh test for stability.

05 hours

Text Books

1. Process System analysis and control by Donald R Coughnowr, 2nd Edn. Mc Graw Hill, 1991
2. Chemical Process Control by George Stephanopoulos, Prentice Hall of India, 1999

Reference Books

1. Process Control-Peter Harriott, Tata McGraw-Hill Publishing Company Limited, 2004.

Scheme for End semester assessment (ESA)

UNIT	8 Questions to be set of 20 Marks Each	Chapter numbers	Instructions
I	3 Questions to be set of 20 Marks Each	1,2	Solve Any 2 out of 3
II	3 Questions to be set of 20 Marks Each	3,4,5	Solve Any 2 out of 3
III	2 Questions to be set of 20 Marks Each	6,7	Solve Any 1 out of 2

Program: Biotechnology		
Course Title: Bio Analytical Techniques		Course Code: 19EBTE301
L-T-P: 3-0-0	Credits: 3.0	Contact Hours: 03 Hours/Week
ISA Marks: 50	ESA Marks: 50	Total Marks: 100
Teaching Hours: 40	Examination Duration: 03 Hours	
Unit I		
<p>1. Introduction to Bio-analysis Introduction to instrumentation, Functional elements of an instrumentation system, static and dynamic characteristics, calibration of instrumental methods, Types of errors, Methods of expressing precision and accuracy, Confidence limits, Uncertainties in Instrumental measurements – Sensitivity and detection, preparation & storage of solutions, usage of laboratory glasswares, statistical analysis of experimental data, Electrodes and Biochemical preparation.</p> <p style="text-align: right;">05 Hours</p>		
<p>2. Spectroscopy General principles–Radiation, energy and atomic structure- types of spectra and their biochemical usefulness basic laws of light absorption. Electromagnetic radiation & Spectrum, Beer – Lambert’s Law and apparent deviations; UV – VIS Spectrophotometer</p> <p style="text-align: right;">05 Hours</p>		
<p>3. Advanced Spectroscopy Spectrofluorimetry, Atomic absorption spectroscopy, IR spectroscopy, FTIR, Nuclear Magnetic Resonance, Mass spectroscopy, ORD, CD, X-ray diffraction.</p> <p style="text-align: right;">05 Hours</p>		
Unit II		
<p>4. Chromatographic techniques Analytical techniques for biomolecules purification, Paper chromatography, thin layer chromatography, Column chromatography, Gas chromatography, Ion-exchange chromatography, molecular exclusion chromatography, affinity chromatography, High performance liquid chromatography & UPLC- Principles, Methods, Instrumentation, Detectors, Analysis of data.</p> <p style="text-align: right;">09 Hours</p>		
<p>5. Electrophoretic techniques Theory & application of polyacrylamide & Agarose gel electrophoresis for protein & nucleic acids, capillary electrophoresis, pulsed field gel electrophoresis, Iso-electric focusing, 2D-gel electrophoresis and Immunoelectrophoresis</p> <p style="text-align: right;">06 Hours</p>		
Unit III		
<p>6. Centrifugation techniques Basic principles of sedimentation, centrifuges and their uses, preparative ultracentrifuges, density gradient ,analytical ultra centrifuges, applications</p> <p style="text-align: right;">06 Hours</p>		

7. Advanced Instrumental methods

LC-MS, GC-MS, HPTLC, SEM, Atomic Force Microscopy, transmission electron microscopy (TEM)

04 Hours

Text Books

1. Wilson K & Walker J., Principles and Techniques of Practical Biochemistry, 5th edition, Cambridge Univ. Press., 2000.
2. Rodney Boyer, Modern Experimental Biochemistry, 3rd edition, Pearson Education, 2002
3. Chatwal and Anand, Spectroscopy, Himalaya Publishing house-New Delhi, 2016

Reference Books

1. Willard H. W. & Meritt L. L, Instrumental methods for chemical analysis, 7th edition. CBS Publishers & Distributors, 2004
2. Chatwal and Anand, Instrumental methods for chemical analysis, Himalaya Publishing house, 2012

Scheme for End semester assessment (ESA)

UNIT	8 Questions to be set of 20 Marks Each	Chapter numbers	Instructions
I	3 Questions to be set of 20 Marks Each	1,2,3	Solve Any 2 out of 3
II	3 Questions to be set of 20 Marks Each	4,5	Solve Any 2 out of 3
III	2 Questions to be set of 20 Marks Each	6,7	Solve Any 1 out of 2

Program: Biotechnology		
Course Title: Bioprocess Plant Design and Economics		Course Code: 18EBTE301
L-T-P: 3-0-0	Credits: 3.0	Contact Hours: 03 Hours/Week
ISA Marks: 50	ESA Marks: 50	Total Marks: 100
Teaching Hours: 40	Examination Duration: 03 Hours	
Unit I		
1. Introduction to Process Design Development		
Design project procedure, design information from the literature and other sources of information, flow diagrams, preliminary design, and comparison of different processes, Equipment design and specialization, factors affecting the investment. 06Hours		
2. General Design Considerations		
Marketability of the product, availability of technology, Health and safety hazards, raw materials, human resources, loss prevention Environmental protection and utilities, site characteristics, plant location, plant layout, plant operation and control, utilities, structural design, storage, materials handling, materials and fabrication Selection, optimum design and design strategy. Waste disposal, physical treatment, chemical treatment and biological treatment, govt. regulations and other legal restrictions, community factors. Safety and hazard control measures. 10 Hours		
Unit II		
3. Cost Analysis and Manufacturing Cost		
Cost Analysis: Factors involved in project cost estimation. Cash flow diagrams for the industrial operation, Cumulative cash position, factors affecting the Investment and production cost, Different methods employed for the estimation of the capital investment. Estimation of equipment cost by sixth tenth rule, Cost index. Marshall and swift installed – equipment indexes, Engineers News-Record construction index, Nelson –Farrar refinery construction index. and Chemical Engineering plant cost index Manufacturing Costs: Direct Production costs, indirect cost and fixed charges (including depreciation, taxes, insurance, rental costs etc.) 10 Hours		
4. Bioprocess Economics:		
Economic analysis for the production of following Products.(Historical Perspective, Fermentation Technology, Recovery of product and process economics of following products)		
<ul style="list-style-type: none"> • High volume, low value products. (Citric acid, Ethanol and Amino acids etc) • Medium volume, medium value products.(Antibiotics, Crude Enzymes and Vitamins etc) • Low volume, high value products. (MAb, purified Enzymes and Therapeutic proteins etc) 06 Hours		

Unit III

5. Profitability Analysis and Optimization Technique

i) Importance of profitability analysis in investment decision making. Different Methods for calculating the profitability. Minimum Acceptable Rate of return. Methods that Do not consider Time value of money. **04 Hours**

ii) General procedure to find the optimum conditions, factors affecting the optimization, comparison of analytical and graphical methods. Linear programming, Simultaneous Equations and dynamic programming **04 Hours**

Text Books:

1. Peters and Timmerhaus, Plant Design and Economics for Chemical Engineers, McGraw Hill 5th edition, 2004.
2. Chemical Engineering plant design, Frank C Vilbrandt and Charles E Dryden , McGraw Hill 4th edition, 1959

Reference Books:

1. Rudd and Watson, Strategy of Process Engineering, Wiley, 1987.
2. Backhurst, J.R And Harker, J. H - Process Plant Design, Heieman Educational Books, (1973).
3. Biochemical Engineering Fundamentals, James E Baily David F Oillis. McGraw-Hill 2nd International Edition

Scheme for End semester assessment (ESA)

UNIT	8 Questions to be set of 20 Marks Each	Chapter numbers	Instructions
I	3 Questions to be set of 20 Marks Each	1, 2	Solve Any 2 out of 3
II	3 Questions to be set of 20 Marks Each	3,4	Solve Any 2 out of 3
III	2 Questions to be set of 20 Marks Each	5	Solve Any 1 out of 2

Program: Biotechnology		
Course Title: Insilco Modeling and Drug Design		Course Code: 15EBTE302
L-T-P: 3-0-0	Credits: 3.0	Contact Hours: 03 Hours/Week
ISA Marks: 50	ESA Marks: 50	Total Marks: 100
Teaching Hours: 40	Examination Duration: 03 Hours	
Unit I		
<p>1. Insilico Drug Design Generation of rational Approaches in Drug Design Molecular modeling: The second generation, Conception frame and methodology of molecular modeling, Importance of the “ Bioactive Confirmation”, Molecular Mimicry and Structural Similarities, Molecular Mimicry, Structural similarities and Superimposition Techniques, Rational Drug design and Chemical Intuition 08 Hours</p>		
<p>2. Molecular Modeling : Constructing and Initial Model, Refining the Model, Manipulating the Model, Visualization. Structure generation or Retrivel, structure visualization, Confirmation generation, Deriving Bioactive Confirmations Molecule Superposition and Alignment Deriving the Pharmacophoric Pattern, Receptor Mapping, Estimating Biological Activities, Molecular Interactions: Docking Calculation of Molecular Properties, Energy Calculations (no derivation), Example of Small Molecular Modeling Work, 08 Hours</p>		
Unit II		
<p>3. Computer Assisted New LEAD Design. Introduction, Basic Concepts, Molecular Recognition by Receptor and Ligand Design, Active Confirmation, Approaches to Discover New Functions, Approaches to the Cases with known and unknown receptor structure 03 Hours</p>		
<p>4. Docking Methods Program GREEN Grid: Three-Dimensional Description of Binding Site Environment and Energy Calculation, Automatic Docking Method, Three Dimensional Database Search Approaches, Automated Structure Construction Methods with known Three Dimensional Structure of the Receptor, Structure construction in the case of Unknown Receptor Structure. Scope and Limitation Points for Consideration in Structure Methods, Handling of X Ray Structure of Protein, Future Perspectives, Types of programs available for molecular modeling scope and limitations-interpretation of results 11 Hours</p>		
Unit III		
<p>5. Computer Assisted Drug Discovery-Part-I. The Drug Development Process, Introduction, The Discovery and Development Process, New Lead Discovery Strategies, Composition of Drug Discovery Teams, The Practice of Computer-Assisted Drug Discovery (CADD), 05 Hours</p>		

6. Computer Assisted Drug Discovery-Part-II.

Current Practice of CADD in the Pharmaceutical Industry, Management Structure of CADD Groups, Contributions and Achievements of CADD Groups, Limitations of CADD Support, Inherent Limitations of CADD Support, State of Current Computational Models, Software and Hardware Constraints.

05 Hours

Text Books:

1. Moody P.C.E. and A.J.Wilkinson Protein Engineering, IRL Press Oxford 1990.
2. The molecular modeling perspective in drug design by N Claude Cohen, 1996, Academic Press

Reference Books:

1. M.Michael Gromiha, Protein Bioinformatics- From Sequence to Function. Academic press 2010
2. Branden C. and Tooze R. Introduction of Protein structure, Garland 1993

Scheme for End semester assessment (ESA)

UNIT	8 Questions to be set of 20 Marks Each	Chapter numbers	Instructions
I	3 Questions to be set of 20 Marks Each	1,2	Solve Any 2 out of 3
II	3 Questions to be set of 20 Marks Each	3,4	Solve Any 2 out of 3
III	2 Questions to be set of 20 Marks Each	5,6	Solve Any 1 out of 2

Program: Biotechnology		
Course Title: Bioprocess Modeling and Simulation		Course Code: 18EBTE401
L-T-P: 3-0-0	Credits: 3.0	Contact Hours: 03 Hours/Week
ISA Marks: 50	ESA Marks: 50	Total Marks: 100
Teaching Hours: 40	Examination Duration: 03 Hours	
Unit I		
<p>1.Introduction to modeling: Introduction, Mathematical Modeling of Bioprocess Engineering System, General Aspects of the Modeling Approach, General Modeling Procedure: Fundamentals uses of mathematical model, scope of coverage, principles of formulation; Fundamental Laws of Modeling: continuity equation, energy equation with examples 05 Hours</p>		
<p>2.Fundamental Laws of Modeling: Equation of motion, transport equation, equation of state, phase and chemical equilibrium, chemical kinetics; Lumped and distributor parameters with examples 05 Hours</p>		
<p>3. Mathematical models of Biochemical Engineering Systems: Modeling of Batch reactors, modeling of CSTR, Numericals. Plug flow reactor, Fluidized bed reactor, Reactors used in effluent treatments, packed bed reactor. 05 Hours</p>		
Unit II		
<p>4. Use of MATLAB in Process Simulation: Basics-Data analysis-curve fittings, Numerical integration, Euler and fourth order RungeKutta method, Input and Output in MATLAB. Solving problems using MATLAB by numerical integration, Euler and fourth order Runge Kutta methods. Simulation of CSTR and Batch Reactor, Simulation of Plug flow reactor. 10 Hours</p>		
<p>4.Introduction to Process Design: Steps involved in process design, Process flow diagram structure and hierarchical approach, importance of Material and Energy balance, selection of unit operations, 05 Hours</p>		
Unit III		
<p>5.Introduction to process simulation software Bioprocess design with example: Process Description, Specifying Process Sections, Specifying Equipment Sharing, Initialization of Reaction Operations, Process Analysis, Cost Analysis and Economic Evaluation, Environmental Impact. 05 Hours</p>		
<p>6. Use of Super Pro in Process Simulation: Components and mixtures, Physical and Chemical properties of components, material and energy balance simulation, adding unit operation, scheduling the unit process, process cost estimation, sizing of the unit operation. Case study: Monoclonal antibody production, Enzyme production</p>		

05 Hours

Text Books:

1. Luyben W.L., Process Modeling Simulation and Control for Chemical Engineers., McGraw Hill, 1988.
2. Pauline M. Doran, "Bioprocess Engineering Calculation", Blackwell Scientific Publications.

Reference Books:

1. Kenneth J. Beers. "Numerical Methods for Chemical Engineering Applications in MATLAB®", Massachusetts Institute of Technology, Cambridge University press 2007 edition.
2. Bailey and Ollis, "Biochemical Engineering Fundamentals", 2 nd ed., McGraw Hill, 1986.

Scheme for End Semester Assessment (ESA)

UNIT	8 Questions to be set of 20 Marks Each	Chapter numbers	Instructions
I	3 Questions to be set of 20 Marks Each	1, 2	Solve Any 2 out of 3
II	3 Questions to be set of 20 Marks Each	3,4	Solve Any 2 out of 3
III	2 Questions to be set of 20 Marks Each	5,6	Solve Any 1 out of 2

Program: Biotechnology		
Lab Title: Minor project		Lab Code:15EBTW302
L-T-P: 0-0-6	Credits: 06	Contact Hours: 18 hrs/week
ISA Marks: 50	ESA Marks: 50	Total Marks: 100
Teaching Hours: 18 hrs/week	Examination Duration: 03 hours	

Guidelines:

- Minor project to be carried out in a group of maximum 4 students.
- Every student needs to maintain laboratory work book which should contain the details of all the work carried out in the laboratory.
- Entries to be done in log books for instrument usage.
- Timely report submission to the coordinator.
- Requisitions for chemicals and glassware's to be provided in advance for the project work

Review committee:

- Review committee is formed by the project coordinator taking into consideration that review committee consists of faculty experts from all domains. Review committee consists of the guide of the respective project group also.

Reviews:

- Continuous internal evaluation will be done by the respective guides/review committee as per the rubrics.
- Total of 3 reviews per semester will be carried out to evaluate the progress of the project.
- During review-1 students have to submit a report duly signed by guide.
- Final evaluation will be done by examiners during End semester assessment as per the ESA evaluation scheme.

Phases of minor project:

Sl. No	Phases	Reviewed	Activities
1	Review-1	By Review committee	Need analysis, Detail Review of literature, Objectives, Overall plan of work.
2	Review-2	By Project Guide	Development of protocols, Standardization and screening. Design of experiments, Conduct of experiments, Initial experimental data.
3	Review-3	By Review committee	Final experimentation, Data interpretation and analysis, Conclusion.

Program: Biotechnology		
Course Title: Bioprocess Engineering Lab		Course Code: 15EBTP303
L-T-P: 0-0-1.5	Credits:1.5	Contact Hours: 3Hrs/week
ISA Marks: 80	ESA Marks: 20	Total Marks: 100
Teaching Hours: 36	Examination Duration: 03 Hours	
<p>List of Experiments:</p> <ol style="list-style-type: none"> 1. Study of Lab fermenter with respect to design and process control parameter 2. Comparison of Batch and fed batch growth kinetics. 3. Determination of thermal death kinetics of microorganism 4. Determination of kinetic parameters of microorganism using batch mode. 5. Kinetics of product formation & substrate degradation 6. Design an experiment to determine mixing time and power requirement of fermenter 7. Determination of K_{La} 8. Solid state fermentation 9. Design an experiment to study the effect of mass transfer on microbial growth. 10. Introduction to bioprocess modeling and simulation software: SuperPro. 11. Building model for batch reactor using SuperPro 		
<p>Text Books/Reference Books</p> <ol style="list-style-type: none"> 1. Pauline M. Doran, Bioprocess Engineering Principles, 2, Academic Press, 2003 2. Stanbury & Whittaker, Principles of Fermentation Technology, 2, Pergamum Press, 2000 		

Program: Biotechnology		
Course Title: Bioprocess Control & Reaction Engineering Lab		Course Code: 19EBTP301
L-T-P: 0-0-1.5	Credits: 1.5	Contact Hours: 02 Hours/Week
ISA Marks:80	ESA Marks:20	Total Marks:100
Teaching Hours:24 Hours	Examination hours	Duration:3
List of Experiments:		
<ol style="list-style-type: none"> 1. Study of characteristics of Transducers (such as Resistance Temperature Detector (RTD) sensor, Thermister, Thermocouple). 2. Determination of Time constant of given first order system (such as mercury in glass thermometer, bimetallic thermometer, RTD sensor using step response). 3. Response of first order system for step & Impulse inputs. 4. Response of first order systems arranged in Non-interacting mode for standard inputs (like step input, Impulse Input). 5. Response of first order systems arranged in Interacting mode for standard inputs (like step input, Impulse Input). 6. Transient response of change in set point/load variable on different control systems (such as Temperature, Pressure and Flow control systems) using different controllers (such as P-controller, PI-Controller, ON-Off controller etc). 7. Linearization of Non Linear Systems (such as control Valve). 8. Analyze the characteristics of different types of reactors (PFR & MFR) 9. Determination of Vessel dispersion number 10. Determination of rate constant for first order reaction. 		
Text Books/Reference Books		
<ol style="list-style-type: none"> 1. Process System analysis and control by Donald R Coughnowr, 2nd Edn. Mc Graw Hill, 1991 2. Chemical Process Control by George Stephanopoulos, Prentice Hall of India, 1999 		

1.1.3. Number of courses having focus on employability/ entrepreneurship/ skill development during the year.

Year of offering: 2021-22

Batch- 2018-22 (7th semester)

Program: Biotechnology		
Course Title: Downstream Processing Technology		Course Code: 19EBTC401
L-T-P: 4-0-0	Credits: 4.0	Contact Hours: 04 Hours/Week
ISA Marks: 50	ESA Marks: 50	Total Marks: 100
Teaching Hours: 50	Examination Duration: 03 Hours	
Unit I		
1. Introduction		
Role and importance of downstream processing in biotechnological processes. Characteristics of biological mixtures, Process design criteria for various classes of byproducts (high volume, low value products and low volume, high value products), Steps involved, case studies, costing of product and numericals		
09 Hours		
2. Primary Separation Techniques		
Cell disruption methods for intracellular products, Removal of insolubles, Biomass (and particulate debris) heat and photosensitive materials (considering lyophilization) separation techniques; Flocculation and Sedimentation, Centrifugation and methods of centrifugation, filtration methods and types of filter media, numericals.		
11 Hours		
Unit II		
3. Membrane separation processes		
Membrane – based separations theory; Design and configuration of membrane separation equipment; Concentration polarization and fouling – causes, consequences and control techniques; Applications: Reverse osmosis, Dialysis, Ultra filtration, Micro filtration, Numerical of membrane separation process, Case Studies.		
12 Hours		
4. Enrichment operations		
Precipitation methods with salts, organic solvents, and polymers, Extraction methods for separations. Reversed micellar extraction and Aqueous two-phase extraction, Supercritical extraction; In situ product removal / integrated bio-processing, numericals.		
08 Hours		
Unit III		
5. Product recovery-I		
Introduction to chromatography (Van Deemter equation), reversed phase chromatography, Hydrophobic Interaction Chromatography, Ion Exchange Chromatography, numericals.		

05 Hours

6. Product recovery-II

Gel Filtration Chromatography, Affinity Chromatography, Polishing Operations: Crystallization, Drying, Delivery of biotechnological product to the end user

05 Hours

Text Books:

1. B. Sivasankar, Bioseparations: Principles and Techniques , Eastern Economy Edit, Prentice-H, 2005
2. P.A. Belter E.L. Cussler, W.S. Hu, Bioseparations: downstream processing for biotechnology, John-Wiley, New York, 1988

Reference Books:

1. BIOTOL, Product Recovery in Bioprocess Technology, VCH, 1990
2. Shuler and Kargi , Bioprocess Engineering , Prentice Hall, 1992
3. Asenjo J. and Dekker M, Separation Processes in Biotechnology , 1993 CRC Press

Scheme for End Semester Assessment (ESA)

UNIT	8 Questions to be set of 20 Marks Each	Chapter numbers	Instructions
I	3 Questions to be set of 20 Marks Each	1, 2	Solve Any 2 out of 3
II	3 Questions to be set of 20 Marks Each	3,4	Solve Any 2 out of 3
III	2 Questions to be set of 20 Marks Each	5,6	Solve Any 1 out of 2

Program: Biotechnology		
Course Title: Bioprocess Equipment Design		Course Code: 15EBTC402
L-T-P: 3-0-0	Credits: 3.0	Contact Hours: 03 Hours/Week
ISA Marks: 50	ESA Marks: 50	Total Marks: 100
Teaching Hours: 40	Examination Duration: 03 Hours	
Unit – I		
1. Notation and terminologies		
Pipe Joints: Flanged pipe joint, Hydraulic pipe joint, Gland & stuffing box expansion joint, Union joint, Socket & spigot Joint. Welded joints: Butt, Fillet, lap welded joint. Vessel openings: Manholes, nozzles, drains, sight Glasses. Pipe design: Basic notation and terminologies, Schedule 10 and 40. Introduction to design.		
04 Hours		
2. Materials of Construction		
Material properties: Mechanical & types of Corrosion; Materials used: Stainless steel and their alloys, properties of different metals used in stainless steel, Selection criteria, Different Standards (Indian steel codes, American Society for Mechanical Engineers-Bioprocess Engineer (ASME BPE) standard, AISI (American Iron & Steel Institute) standard), different Stainless steel grade: 304, 316.		
08 Hours		
Unit – II		
3. Design of Bioreactor		
Fermenter: Steps involved in the design: Volume of Reactor, H/D ratio, impeller design, baffle design, shaft design, Thickness of the shell, thickness of the top & bottom Cover, thickness of jacket, heat transfer area of jacket, Power number, Power required to drive the Impeller.		
09 Hours		
4. Design of shell and tube Heat exchanger		
Heat exchangers: Steps involved in the design, Energy balance, LMTD, Tubing characteristics, Tube side heat transfer coefficient, baffle spacing, shell side heat transfer coefficient, Fouling, Overall heat transfer coefficient, Tube side & shell side Pressure drop calculations.		
09 Hours		
Unit – III		
5. Equipment qualification & Validation		
Design qualification, FAT (factory acceptance test), Site acceptance test, Commissioning, Installation Qualification, Operational qualification, Performance qualification, Equipment validation.		
05 Hours		

6. Bioreactor Accessories

Sterilization by filters, Design criteria for filters, filter housing, Filter Integrity test: Diffusive air flow test, Bubble point test, Pressure drop test, Water intrusion test; Valves: Diaphragm valve, Pneumatic valve, pinch valve, Non-return safety Valve; Aseptic seals in fermenter (Gasket, Lip seal, O rings).

05 Hours

Text Books:

1. Chemical Engineering Design by R K Sinnott, vol-6, 4th edition, Butterworth-Heinemann, 2005.
2. Process Equipment Design by M. V. Joshi & V. V. Mahajani, 3rd edition, Macmillan India Ltd, 1996.

Reference Books:

1. Fermentation & Biochemical engineering handbook by H. C. Vogel & C. L. Todaro, 2nd edition, Standard publishers distributors.
2. Introduction to chemical equipment design by B. C. Bhattacharyya, 1st edition, CBS Publishers & distributors, 1985

Scheme for End Semester Assessment (ESA)

UNIT	8 Questions to be set of 20 Marks Each	Chapter numbers	Instructions
I	3 Questions to be set of 20 Marks Each	1, 2	Solve Any 2 out of 3
II	3 Questions to be set of 20 Marks Each	3,4	Solve Any 2 out of 3
III	2 Questions to be set of 20 Marks Each	5,6	Solve Any 1 out of 2

Program: Biotechnology		
Course Title: Industrial Biotechnology		Course Code: 20EBTE401
L-T-P: 3-0-0	Credits: 3.0	Contact Hours: 03 Hours/Week
ISA Marks: 50	ESA Marks: 50	Total Marks: 100
Teaching Hours: 40	Examination Duration: 03 Hours	
Unit I		
1 Introduction		
History of fermentation products, Range of fermentation process: Traditional approach: biomass, enzymes, metabolites and biotransformation; Modern fermentation process: rDNA products, animal cell culture: therapeutic proteins, monoclonal antibodies; application of system biology approach; generalized representation of typical fermentation process.		
05Hours		
2. Isolation and improvement of industrial microorganisms		
Isolation methods: Primary screening and secondary screening; Improvement of industrial microorganism: selection of induced mutants for primary and secondary metabolites, isolation of revertant mutants, use of rDNA systems, and improvement by other properties.		
05Hours		
3. Fermentation products		
Beverages(beer), Ethanol, Aminoacids, enzymes(lipase/protease), penicillin, therapeutic proteins, monoclonal antibodies and vaccines.		
05Hours		
Unit II		
4 Bioreactor configuration-I		
CSTR with recycle, CSTR in series, Airlift reactor, Fluidized bed bioreactor, bubble column bioreactor, packed bed bioreactor, trickle bed bioreactor, deep jet bioreactor, rotating disc bioreactor.		
05Hours		
5. Bioreactor configuration-II		
Animal cell bioreactors:- Homogeneous reactor: Solid and macro porous micro carriers bioreactor; Heterogeneous reactor: Hollow fiber bioreactor, Packed glass bed bioreactor, fluidized bed bioreactor, cell encapsulation; Disposable bioreactor: Wave bioreactor and stirred bag bioreactor, Perfusion system- single use reactor and Open raise ponds, photo bioreactor.		
05Hours		
6. Advance downstream processing		
Process integration in product recovery, large scale refolding of therapeutic proteins, advanced membrane technology, Chromatography: column quantification and validation, AKTA purifier, reversed micellar technique for bio separation Single use technology in purification.		
05Hours		
Unit III		
7. Fermentation monitoring and control:		

On-line and off-line monitoring instruments, Bioprocess modeling for control, Estimation technique: Traditional method, linear black-box model and non-linear model; control strategies for fermentation, real time data analysis: Raman spectroscopy.

05 Hours

8. Fermentation data analysis:

Introduction, classification of fermentation measurement and quantities, calculation of metabolites, estimation of unmeasured variables, calculation of integral and averaged variable, physiological variable and pattern recognition technique, SIMCA software.

05Hours

Text Books:

1. L.E.Casida, JR ,Industrial Microbiology, New Age International (P) Ltd Publication.
2. Prescott and Dun, Industrial Microbiology, McGraw-Hill Book Company, Inc. New York

Reference Books:

1. D.Lanch,Drew,Wang, Comprehensive Biotechnology-Volume 3,Elsevier Publication.
2. George T. Austin, Nicholas Basta; Shreves Chemical Process Industries Handbook; McGraw Hill Professional, 1998

Scheme for End Semester Assessment (ESA)

UNIT	8 Questions to be set of 20 Marks Each	Chapter numbers	Instructions
I	3 Questions to be set of 20 Marks Each	1, 2,3	Solve Any 2 out of 3
II	3 Questions to be set of 20 Marks Each	4,5,6	Solve Any 2 out of 3
III	2 Questions to be set of 20 Marks Each	7a,7b	Solve Any 1 out of 2

Program: Biotechnology		
Course Title: Food Processing Technology		Course Code: 15EBTE402
L-T-P: 3-0-0	Credits: 3.0	Contact Hours: 03 Hours/Week
ISA Marks: 50	ESA Marks: 50	Total Marks: 100
Teaching Hours: 40	Examination Duration: 03 Hours	
Unit I		
1. Fundamentals of Food Processing Technology		
Basic concepts about properties of foods: liquid, solid and gases; Introduction to food processing: scope and significance; Principles of food processing and preservation		
04 Hours		
2. Microbial Food Spoilage		
Food as substrate for microorganisms, Primary sources of micro organisms in foods, Microbes induced biochemical changes in foods, Microbiological Examination of foods , Food poisoning, and types. , A brief account of various organisms related with food poisoning- <i>E. coli</i> , <i>Clostridium</i> , <i>Bacillus</i> , <i>Staphylococcus</i> and <i>Vibrio</i>		
07 Hours		
3. Food biotechnology and Applications		
Enzymes, organic acids, antibiotics, baker's yeast, single cell protein and Mushrooms. Biocolours, Concept of fermented foods and beverages, Probiotics, Prebiotics & Symbiotics, Genetically Modified Foods		
04 Hours		
Unit II		
4. Unit Operations in Food Processing		
Introduction, Food Engineering operations- raw material preparation, cleaning, sorting, grading and peeling. Food conversion operations- size reduction, emulsification, filtration, membrane separation, centrifugation and extraction. Pulsed Electric Field processing, High-Pressure Processing,		
04 Hours		
5. Thermal Processing of Foods		
Heat processing using steam or water, Blanching, Pasteurization, Heat Sterilization, Evaporation, Distillation, Extrusion and Canning. dielectric heating, ohmic and infrared heating. Dehydration, Intermediate Moisture Foods, Baking and Roasting, Heat processing using hot oils- Frying.		
06 Hours		
6. Non-Thermal Processing of Foods		
Chilling, Freezing, Freeze-drying, Vacuum Concentration, Processing by chemical methods- sugar, salt, curing, smoking, acid and chemicals. Irradiation of foods. Controlled and Modified- Atmosphere Packaging. Concept of hurdle technology.		
05 Hours		

Unit III

7. Food Product Development

Concept and need of new product development, testing and sensory evaluation, Development of product formulation and development, Role of food ingredients in human health Packaging and shelf life of food products. Concept of Functional Foods and Nutraceuticals.

05 Hours

8. Food laws, Labeling and Regulatory Bodies

Food Laws- General Standards and Regulations as per FSSAI, . Regulatory bodies governing food laws. Certification and labeling of foods. Concept of HACCP and AGMARK

05 Hours

Text Books:

1. P.J.Fellows, Food Processing Technology. Principles and Practices, Second Edition, Woodland Publishing Ltd, Cambridge, England, 2002
2. Avantina Sharma, Text Book of Food Science and Technology, International Book Distributing Co, Lucknow, UP, 2006

Reference Books:

1. Ramaswamy H & Marcotte M. Food Processing: Principles and Applications. Taylor & Francis. 2006

Scheme for End Semester Assessment (ESA)

UNIT	8 Questions to be set of 20 Marks Each	Chapter numbers	Instructions
I	3 Questions to be set of 20 Marks Each	1, 2,3	Solve Any 2 out of 3
II	3 Questions to be set of 20 Marks Each	4,5,6	Solve Any 2 out of 3
III	2 Questions to be set of 20 Marks Each	7,8	Solve Any 1 out of 2

Program: Biotechnology		
Course Title: Plant and Animal Biotechnology		Course Code: 15EBTE403
L-T-P: 3-0-0	Credits: 3.0	Contact Hours: 03 Hours/Week
ISA Marks: 50	ESA Marks: 50	Total Marks: 100
Teaching Hours: 40	Examination Duration: 03 Hours	
Unit I		
<p>1. Introduction to plant tissue culture Introduction and scope of plant tissue culture. Historical events in the development of plant tissue culture method. Practical applications and recent advances. Laboratory organization, Cell culture media and its components. Aseptic manipulation in plant tissue culture laboratory. . Ethical and Social issues related to development and release of transgenic plants with case studies – Bt Cotton.</p> <p style="text-align: right;">05 Hours</p>		
<p>2. Methods and Techniques in Plant tissue Culture. Callus and suspension culture, Micropropagation, Protoplast culture & Somatic Hybridization, Anther & Ovary Culture, Somatic Embryogenesis, Embryo & Endosperm culture, Somaclonal variation Germplasm storage by cryopreservation – pretreatment for cryopreservation, freezing, thawing, plant growth and regeneration and applications.</p> <p style="text-align: right;">04 Hours</p>		
<p>3. Introduction to animal cell and tissue culture History and Scope of Animal cell and Tissue culture, Advantages and Disadvantages of Cell culture, laboratory facilities for tissue culture. Culture media for cells and tissues. Laboratory layout, Essential equipments and Consumable items, Aseptic Techniques- elements of aseptic environment and culturing vessels Types of tissue culture – Primary cultures and Cell lines maintenance of cell line cultures</p> <p style="text-align: right;">06Hours</p>		
Unit II		
<p>4.Culture characterization and culture maintenance Need for characterization, Parameters of Characterization, Cell Morphology, Confocal microscopy, DNA content analysis, Enzyme activity and Antigenic markers. Contamination in cell culture – sources, monitoring and eradication of contamination Cryopreservation and transportation.</p> <p style="text-align: right;">04 Hours</p>		
<p>5. Animal Cell culture Scale up and Automation Introduction to scale up and automation. Scale up in suspension culture: Continuous culture, Scale & complexities, Mixing & Aeration. Scale up in Monolayer culture: Multi surface propagators, Roller culture, Microcarriers, and Perfused Monolayer culture. Process control and Automation: Robotic cell culture and High throughput screening.</p> <p style="text-align: right;">05 Hours</p>		
6. Animal cell culture and Biopharmaceuticals production		

Mammalian cells as desired expression systems for protein biopharmaceuticals, Construction and selection of high-producing cell lines, Medium development for mammalian cell culture, and Process development for mammalian cell culture. Single use disposable animal cell culture technologies for biopharmaceutical manufacturing. **06 Hours**

Unit III

7. Plant Cell culture and Secondary Metabolite production

Introduction, Selection of high yield cells and Mass cultivation of plant cells: Free cell suspension culture, Immobilized plant cell culture, and Two phase system culture. Elicitor induced accumulation of products. Biotransformation using plant cell cultures, Genetic modification and factors limiting large scale production of useful compounds.

05 Hours

8. Animal cell culture applications and Tissue engineering

Hybridoma Technology and Animal cell culture applications in Monoclonal antibodies production. Products of Animal tissue culture – Erythropoietin, Tissue Plasminogen Activator & Factor VIII etc. Tissue Engineering – Introduction, Cell types, Extracellular matrix and Tissue engineering concepts. Artificial skin development by tissue engineering and its applications.

05 Hours

Text Books:

1. Introduction to Plant tissue culture Second edition. M K Razdan Oxford & IBH Publishing Co Pvt Ltd, New Delhi. 2003
2. Animal Cell Culture – Concept and Application by Sheelendra M Bhatt, Narosa Publishing House, New Delhi ISBN: 978-81-7319-926-4

Reference Books:

1. Introduction to Plant Cell, Tissue and Organ culture Sunil D Purohit PHI Learning Private Ltd, New Delhi 2013. ISBN – 978-81-203-4677-2
2. Culture of Animal Cells - A Manual of Basic Technique by R. Ian Freshney A John Wiley & Sons, Inc., Publication New York (2000)

Scheme for End Semester Assessment (ESA)

UNIT	8 Questions to be set of 20 Marks Each	Chapter numbers	Instructions
I	3 Questions to be set of 20 Marks Each	1, 2,3	Solve Any 2 out of 3
II	3 Questions to be set of 20 Marks Each	4,5,6	Solve Any 2 out of 3
III	2 Questions to be set of 20 Marks Each	7,8	Solve Any 1 out of 2

Program: Biotechnology		
Course Title: Biopharmaceuticals		Course Code: 15EBTE404
L-T-P: 3-0-0	Credits: 3.0	Contact Hours: 03 Hours/Week
ISA Marks: 50	ESA Marks: 50	Total Marks: 100
Teaching Hours: 40	Examination Duration: 03 Hours	
Unit I		
<p>1. Introduction: Introduction to pharmaceutical industry, API and pharmaceutical products, Formulation Industry, Introduction to dosage forms, Biopharmaceuticals & Biotechnology, Biopharmaceuticals: Current status & future prospects. Drug discovery & development process, Sources of Biopharmaceuticals, Dosage forms and routes of drug administration.</p> <p style="text-align: right;">06 Hours</p>		
<p>2. Pharmacokinetic and Pharmacodynamics of Peptide & Protein Drugs: Introduction to pharmacokinetics and pharmacodynamics, drug as agonist & antagonist, Pharmacokinetics of protein therapeutics, ADME study for small molecules & protein therapeutics, optimization of pharmacokinetic profile, Pharmacodynamics of protein therapeutics, PK/PD Models.</p> <p style="text-align: right;">10 Hours</p>		
Unit II		
<p>3. The Drug Manufacturing Process: Pharmacopeias, good manufacturing practices (GMP), good laboratory practices (GLP), manufacturing facilities, clean rooms, water plant & grades of water, production of final product & formulation, analysis of final product (Qualitative & Quantitative), documentation: SOP, specifications & records, batch manufacturing records (BMR), batch packaging records (BPR).</p> <p style="text-align: right;">08 Hours</p>		
<p>4. Therapeutic Agents: The cytokines (Interleukins & Interferons), haemopoietic growth factors (erythropoietin), hormones of therapeutic interest (insulin & glucagon), preservation and clinical use of blood products, therapeutic enzymes, monoclonal & polyclonal antibodies, vaccines and vaccine technology (with appropriate case studies).</p> <p style="text-align: right;">08 Hours</p>		
Unit III		
<p>5. Quality in Pharmaceutical Industry: Quality Assurance & Quality Control, validation & qualification studies, aseptic fill-process validation, cleaning validation, Validation Master Plan, Qualification: IQ, OQ and PQ. Calibration of analytical instruments.</p> <p style="text-align: right;">04 Hours</p>		
6. Regulatory issues and Drug product approval		

Drug approval process (NDA & ANDA), Regulatory framework: Quality, Safety & Efficacy, Biosimilars and follow-on biologics, FDA & its Organizational structure, European regulations, Drug Registration in Japan, World harmonization of drug approvals (The ICH).

04 Hours

Text Books:

1. Biopharmaceuticals: Biochemistry & Biotechnology. Author: Gary Walsh. Second Edition, 2011. Pub: John Wiley & Sons.
2. Pharmaceutical Biotechnology: Fundamentals and Applications. Ed: Daan J.A. Crommelin et al. Third Edition. Publisher: Informa Healthcare.

Reference Books:

1. Molecular Biotechnology: Principles & Applications of r-DNA. Author: Bernard Glick & Jack Pasternak. 2002. Pub: Panima Books.
2. Manual of Industrial Microbiology & Biotechnology by Arnold L. Demain. 1999 Pub: ASM Press.
3. Biopharmaceuticals: An Industrial perspective. Authors: Gary Walsh & Brendan Murphy. 2009. Pub: Spring Books.

Scheme for End Semester Assessment (ESA)

UNIT	8 Questions to be set of 20 Marks Each	Chapter numbers	Instructions
I	3 Questions to be set of 20 Marks Each	1, 2	Solve Any 2 out of 3
II	3 Questions to be set of 20 Marks Each	3,4	Solve Any 2 out of 3
III	2 Questions to be set of 20 Marks Each	5,6	Solve Any 1 out of 2

Program: Biotechnology		
Course Title: Genomics and Proteomics		Course Code: 15EBTE405
L-T-P: 3-0-0	Credits: 3.0	Contact Hours: 03 Hours/Week
ISA Marks: 50	ESA Marks: 50	Total Marks: 100
Teaching Hours: 40	Examination Duration: 03 Hours	
Unit I		
<p>1. Introductory Genomics Genomics- Introduction, History and Scope and types, Structure of prokaryotic and eukaryotic genome, Mitochondrial and Chloroplast genome, C- value of genome. Genomics Approaches – traditional and updated, Genome mapping as an approach of genomics and recent approaches of genomics.</p> <p style="text-align: right;">04 Hours</p>		
<p>2. Genome Analysis and markers Genome analysis and markers – Introduction, necessity and tools of genome analysis and markers. Genome Sequencing - Whole genome Shot gun, Hierarchical Shotgun, High-throughput sequencing, Chromosome walking, Chromosome jumping, Next Generation Sequencing. Molecular Markers: Concept of Markers, different types of markers and their general applications. Brief introduction to nature and applications of RFLP, RAPD, AFLP, SNP, Micro satellites, Minisatellites, Short Sequence Repeats, VNTR, EST, STS, Marker Assisted Selection</p> <p style="text-align: right;">07 Hours</p>		
<p>3. Genomics- Recent Advancements and Applications Microarray analysis, Genomic libraries, Gene-disease associations. Genomics Applications: Nutrigenomics, Toxicogenomics, Pharmacogenomics, Metagenomics, Medical applications, Human Genome Project. Model Organisms for Genomics studies- Yeast and Drosophila</p> <p style="text-align: right;">04 Hours</p>		
Unit II		
<p>4. Introductory Proteomics Proteomics- Introduction, History, Scope and Types. Protein – Sequence, Structure and function relationship. Different approaches for proteomics studies and their applications.</p> <p style="text-align: right;">04 Hours</p>		
<p>5. Proteome separation and Purification Proteome extraction and purification. Separation of Proteins- ion-exchange, size exclusion and affinity chromatography techniques, 1-D by Isoelectric focusing, 2-D by SDS-PAGE. Protein Identification- Edman degradation, Mass Spectrometry, MALDI-TOF, Electrospray ionization, Peptide mass fingerprinting.</p> <p style="text-align: right;">08 Hours</p>		
<p>6. Proteomics- Recent Advancements and Applications Applications of proteome analysis to drug; Protein-protein interaction Protein engineering: Protein chips. Clinical and biomedical application of proteomics.</p> <p style="text-align: right;">03 Hours</p>		

Unit III

7. Bioinformatics tools in Genomics

Raw genome sequences, Major Genomic Databases, Genome Annotation, similarity search, Genome sequence alignment tools.

05 Hours

8. Bioinformatics tools in Proteomics

Proteome Databases, Proteome Annotation, Protein characterization and function, Families, patterns, domains and profiles.

05 Hours

Text Books:

1. Bioinformatics- Methods and Applications. Genomics, Proteomics and Drug Discovery. S.C. Rastogi, N. Mendiratta and P. Rastogi. PHI Learning Private Limited, delhi.
2. GENES IX Benjamn Lewin Oxford University and Cell Press 2010

Reference Books:

1. Introduction to Genomics- Arthur Lesk. Oxford University & Cell Press
2. Principles of Proteomics by R M Twyman BIOS Scientific Publishers 2004

Scheme for End Semester Assessment (ESA)

UNIT	8 Questions to be set of 20 Marks Each	Chapter numbers	Instructions
I	3 Questions to be set of 20 Marks Each	1, 2,3	Solve Any 2 out of 3
II	3 Questions to be set of 20 Marks Each	4,5,6	Solve Any 2 out of 3
III	2 Questions to be set of 20 Marks Each	7,8	Solve Any 1 out of 2

Program: Biotechnology		
Course Title: Environmental Biotechnology		Course Code: 18EBTE404
L-T-P: 3-0-0	Credits: 3.0	Contact Hours: 03 Hours/Week
ISA Marks: 50	ESA Marks: 50	Total Marks: 100
Teaching Hours: 40	Examination Duration: 03 Hours	
Unit I		
<p>1. Introduction Issues and scope of Environmental Biotechnology, Environment and Biotechnology, Areas of applications for Biotechnology. Microbes and Environment, Genetically modified organisms and Legislation. 03 Hours</p>		
<p>2. Waste Water Treatment Sources of water pollution, Waste water characteristics: Physical, Chemical and Biological characteristics. Chemical Oxygen Demand (COD) and Biochemical Oxygen Demand (BOD). Introduction to physical and chemical waste water treatment methods. Biological wastewater treatment methods: Aerobic suspended growth treatment processes (Activated Sludge Process, aerated lagoons etc), Aerobic attached growth treatment processes (Trickling Filter, Rotating Biological contactors), Anaerobic suspended growth treatment processes- contact digestors, packed column reactors, UASB. 12 Hours</p>		
Unit II		
<p>3. Solid waste Management Basic aspects, Generation of solid wastes, general composition of Municipal solid waste, On site handling, storage and processing, Collection of solid wastes. Solid waste processing techniques and equipments. Recovery of biological conversion products from solid waste such as composting, sanitary landfilling, recycling, vermicomposting, incineration. Solid waste management for energy recovery-Biogas production, processing of lignocellulosic waste biomass for ethanol production 10 Hours</p>		
<p>4. Bioremediation Uses of bacteria for bioremediation, bioremediation of aromatic and aliphatic hydrocarbons, PCB dechlorination, immobilization techniques for bioremediation, biosorption & bioaccumulation, genetic engineering of microbes for bioremediation. Phytoremediation-plants capable of assimilating heavy metals 05 Hours</p>		
Unit III		
<p>5. Bioleaching Bioleaching using microbes, role of Thiobacilli, direct & indirect bioleaching, copper extraction by leaching, dump leaching 05 Hours</p>		
<p>6. Environmental Impact Assessment Introduction, Scope and history of EIA, Need of Environmental Impact assessment. Stakeholder and public involvement, Identification and quantification of environmental effects and Environmental Impact statement (EIS) 05 Hours</p>		

Text Books:

1. Metcalf and Eddy, Wastewater Engineering, International Edition, McGraw-Hill, 1991
2. George Tchobanoglous, Hilary Theisen and Rolf Eliassen, Solid Wastes, McGraw Hill Kogakusha

Reference Books:

1. Colin Ratledge, Basic Biotechnology , Cambridge Pub, 2001
2. Indu Shekhar Thakur, Environmental Biotechnology, IK Pub, 2006
3. Pradipta Kumar Mohapatra, Environmental Biotechnology, IK Pub, 2006

Scheme for End Semester Assessment (ESA)

UNIT	8 Questions to be set of 20 Marks Each	Chapter numbers	Instructions
I	3 Questions to be set of 20 Marks Each	1,2	Solve Any 2 out of 3
II	3 Questions to be set of 20 Marks Each	3,4	Solve Any 2 out of 3
III	2 Questions to be set of 20 Marks Each	5,6	Solve Any 1 out of 2

Program: Biotechnology		
Course Title: Quality Assurance & Regulations		Course Code: 18EBTE403
L-T-P: 3-0-0	Credits: 3.0	Contact Hours: 03 Hours/Week
ISA Marks: 50	ESA Marks: 50	Total Marks: 100
Teaching Hours: 40	Examination Duration: 03 Hours	
Unit I		
<p>1. Introduction Introduction to Quality and Quality Regulation, Validation and Regulatory Affairs in Bio (Pharmaceutical) Manufacturing: An Introduction to FDA Operations & Industry Compliance Regulations, The Fundamentals of Regulatory Compliance with respect to Good Clinical Practice (GCP), Good Manufacturing Practice (GMP) & Good Laboratory Practice (GLP). 06 Hours</p>		
<p>2. Quality and Quality Management Terms Relating to Quality Management System, Quality Policy, Quality Objectives, Quality Planning, Quality Control, Quality Assurance, Quality Improvement, Continual Improvement, Effectiveness, Efficiency; Relating to Process and Product, Quality Characteristics; Terms Relating to Conformity, Non-Conformity, Defect, Preventive Action, Corrective Action, Rework, Repair, Scrap, Concession, Deviation Permit, Release; Terms Relating to Documentation. 10 Hours</p>		
Unit II		
<p>3. Process Validation Definition and concept of validation, An introduction to process validation, Validation and Qualification, IQ, OQ and PQ. A Review of Prospective, Concurrent, Retrospective Validation Calibration and performance evaluation. Validation of Water & Thermal Systems, including HVAC Facilities & Cleaning Validation. Validation septic Processes, Computer software validation in pharmaceuticals (CSV). 10 Hours</p>		
<p>4. Analytical Method Validation FDA and ICH guidelines. Analytical method validation, Specificity, Linearity, Accuracy, Precision, Limits of detection (LOD) and quantification (LOQ), Minimum detectable amount (MDA), Sample stability and method robustness, System suitability, Statistical process control for HPLC, Troubleshooting out-of-control systems, Case studies, Validation of Analytical Methods. 06 Hours</p>		
Unit III		
<p>5. Quality Standards Introduction, ISO 9000 Series of Standards, Management Responsibility, Quality System, Contract Review, Design Control, Document and Data Control, Control of Quality Records, Internal Quality Audits, Training, Servicing, Environmental Management System. 04 Hours</p>		

6. Implementation and Regulation

Role of QC and QA in Bio/Pharmaceutical organization, Quality System, Contract Review, Design Control, Document and Data Control, Product Identification and Traceability, Process Control, Control of Quality Records, Internal Quality Audits, Training.

04 Hours

Text Books:

1. Pharmaceutical Process Validation by Robert Nash and Alfred Wachter, Marcel Dekker. Publisher: Marcel Dekker Inc. 2011.
2. Good Manufacturing Practices for Pharmaceuticals: A Plan for Total Quality Control From Manufacturer to Consumer, Sidney J. Willig, Publisher: Marcel Dekker Inc. 2005.

Reference Books:

1. Validation of Pharmaceutical Processes: Sterile Products, Frederick J. Carlton (Ed.) and James Agalloco (Ed.), Marcel Dekker, 2008.
2. Validation Standard Operating Procedures: A Step by Step Guide for Achieving Compliance in the Pharmaceutical, Medical Device, and Biotech Industries, Syed Imtiaz Haider, Saint Lucie Press, 2004.

Scheme for End Semester Assessment (ESA)

UNIT	8 Questions to be set of 20 Marks Each	Chapter numbers	Instructions
I	3 Questions to be set of 20 Marks Each	1, 2	Solve Any 2 out of 3
II	3 Questions to be set of 20 Marks Each	3,4	Solve Any 2 out of 3
III	2 Questions to be set of 20 Marks Each	5,6	Solve Any 1 out of 2

Program: Biotechnology		
Course Title: Bioethics, Safety & IPR		Course Code:20EBTE403
L-T-P: 3-0-0	Credits: 3.0	Contact Hours: 03 Hours/Week
ISA Marks: 50	ESA Marks: 50	Total Marks: 100
Teaching Hours: 40	Examination Duration: 03 Hours	
Unit I		
<p>1. Perceptions about Biotechnology: Biotechnology and social responsibility, Positive & negative perceptions of Biotechnology, Public acceptance issues, surveys, areas of public concern for Biotechnology. Socio, ethical, economic and legal aspects of Biotechnology. Public education & Biotechnology. 05Hours</p> <p>2. Bioethics: Legality, morality, and ethics, Principles of bioethics: autonomy, human rights, beneficence, justice, equity, etc. Expanding scope of ethics from Biomedical practice to Biotechnology, ethical conflicts in Biotechnology. 05 Hours</p> <p>3. Biosafety concept and issues : Rational vs. subjective perception of risks and benefits, Hazards of BT , relationship between risk and hazard, Ethical implications of biotechnology products and techniques, 05 Hours</p>		
Unit II		
<p>4. National and International Regulations: Cartagena protocol, OECD consensus documents and Codex Alimentarius; Indian regulations – EPA act and rules, guidance documents, regulatory framework – RCGM, GEAC, IBSC and other regulatory bodies; category of rDNA experiments; field trails – biosafety research trials – standard operating procedures - guidelines of state governments; GM labeling – Food Safety and Standards Authority of India (FSSAI) 10Hours</p> <p>5. Biosafety & Management: Laboratory associated Biosafety practices, assessment of biohazard, Biosafety levels,. Risk analysis and assessment, Containment levels-physical, biological containments,. Good manufacturing practice and Good lab practices (GMP and GLP). 05 Hours</p>		
Unit III		
<p>6. Intellectual Property rights: Introduction to history of GATT, WTO, WIPO and TRIPS; Introduction to IPR, Types of IP: Patents, Trademarks, Copyright, Design & Related Rights. Plant variety protection, Traditional knowledge, breeders rights, Geographical indications, Biodiversity and farmers rights. Patenting in biotechnology, case studies. 05 Hours</p> <p>7. Food, Agri and Pharma Sector: The GM-food debate and biosafety assessment procedures for biotech foods including transgenic food crops, case studies- Golden Rice and Flav Savr Tomatto. Biosafety assessment of pharmaceutical products such as drugs/vaccines etc. Biosafety issues in Clinical Trials. 05 Hours</p>		
Text Books		
1.Bioethics & Biosafety- Sateesh MK, I.K.International Publishing House		

2. Intellectual Property rights on Biotechnology – Singh K, BCIL, New Delhi.
3. Biotechnology: Expanding Horizons - B D Singh, Kalayani Publishers, 2010

Reference Books:

1. Bioethics & Biosafety – R. Rallapalli & Gita Bali, APH publication, 2007
2. Safety considerations for Biotechnology-Paris, OECD publications

Scheme for End Semester Assessment (ESA)

UNIT	8 Questions to be set of 20 Marks Each	Chapter numbers	Instructions
I	3 Questions to be set of 20 Marks Each	1,2,3	Solve Any 2 out of 3
II	3 Questions to be set of 20 Marks Each	4,5	Solve Any 2 out of 3
III	2 Questions to be set of 20 Marks Each	6,7	Solve Any 1 out of 2

Program: Biotechnology		
Course Title: Vaccine Technology		Course Code: 21EBTE401
L-T-P: 3-0-0	Credits: 03	Contact Hours: 03 Hours/Week
CIE Marks: 50	SEE Marks: 50	Total Marks: 100
Teaching Hours: 40	Examination Duration: 03 Hours	
Unit I		
1 History of Vaccine Discovery and Development		
Variolation and Vaccination in Late Imperial era, early methods of vaccination, Edward Jenner's Role in the Introduction of Smallpox Vaccine, Eradication of small pox. Fight against polio, Historical background of vaccination, vaccine preventable infectious diseases, Over view of bacterial and viral vaccines and their importance to public health. Epidemiology and pathophysiology of vaccine preventable diseases with special emphasis on Diphtheria, and Tetanus.		
07 Hours		
2. Role of vaccines in epidemiology and public health system.		
Active and passive immunization, General immunization practices, Strategies for improving vaccination levels. Timing and Spacing of Vaccines.. Adverse Reactions Following Vaccination. Contraindications and Precautions to Vaccination. Role of B and T cells, primary and secondary immune response, Immunological memory, Booster doses, Factors influencing the magnitude of vaccine performance, adjuvants. Immune correlates in vaccine development.		
08 Hours		
Unit II		
3. Vaccine design, development and types:		
Subunit vaccine component - antigen, delivery system. Structure-based Vaccine design - tools and techniques. Characters of effective vaccines: Vaccines, Live, killed, attenuated, sub unit vaccines, conjugated vaccines. Vaccine technology- Role and properties of adjuvants, recombinant DNA and protein based vaccines, plant-based vaccines, reverse vaccinology; Peptide vaccines, conjugate vaccines, Edible vaccines.		
06 Hours		
4. Vaccine manufacturing and Quality Control.		
Commercial scale vaccine manufacturing: Upstream (use of cell lines, human diploid) and downstream (chromatography) of active substances. Vaccine formulation (liquid and lyophilization). Use of additives/adjuvants/stabilizers. Vaccine safety and efficacy of vaccines (in vitro and in vivo). cGMP implementation in the production of safe vaccines. Case study of vaccine manufacturing: HBV and polio vaccine		
09 Hours		
Unit III		
5. Policies, ethical considerations and Regulatory affairs of vaccines.		
Regulation and testing of vaccines, Regulation of vaccines in developing countries, Role and		

functioning of National Regulatory Authorities (ICMR) and WHO. Different stages of review and regulation of vaccines (investigational new drug application, biologics license application, post-licensure). Evolution of vaccine regulations overtime and the current status of NRAs functionality globally. Brief on Indian regulatory system.

05 Hours

6. Recent advancements in vaccinology:

Concepts of reverse vaccinology, case study of Reverse Vaccinology. Novel vaccine delivery systems. Tools & servers for computational Vaccine design-from Genome to Vaccine. Antigenicity modification, epitope replacement, germline targeting. Antigenically variable infectious agents and their vaccines.

05 Hours

Text Books

1. IAP Textbook of Vaccines by Nitin K Shah, Rohit Agrawal, Vipin M Vashishtha, TU Sukumaran
2. Vaccines. 6th Edition, Stanley Plotkin Walter Orenstein Paul Offit.

Reference Books

1. Vaccine Development and Manufacturing. Emily P. Wen (Editor), Ronald Ellis (Editor), Narahari S. Pujar (Editor).
2. Vaccines & Vaccine Technologies. Jose Ronnie Vasconcelos

Scheme for End semester examination (ESA)

UNIT	8 Questions to be set of 20 Marks Each	Chapter numbers	Instructions
I	3 Questions to be set of 20 Marks Each	1, 2	Solve Any 2 out of 3
II	3 Questions to be set of 20 Marks Each	3, 4	Solve Any 2 out of 3
III	2 Questions to be set of 20 Marks Each	5, 6	Solve Any 1 out of 2

Program: Biotechnology		
Lab Title: Senior Design Project		Lab Code:20EBTW401
L-T-P: 0-0-6	Credits: 06	Contact Hours: 18 hrs/week
ISA Marks: 50	ESA Marks: 50	Total Marks: 100
Teaching Hours: 18 hrs/week	Examination Duration: 03 hours	

Guidelines:

- Senior Design Project to be carried out in a group of maximum 4 students.
- Every student needs to maintain laboratory work book which should contain the details of all the work carried out in the laboratory.
- Entries to be done in log books for instrument usage.
- Timely report submission to the coordinator.
- Requisitions for chemicals and glassware's to be provided in advance for the project work

Review committee:

- Review committee is formed by the project coordinator taking into consideration that review committee consists of faculty experts from all domains. Review committee consists of the guide of the respective project group also.

Reviews:

- Continuous internal evaluation will be done by the respective guides/review committee as per the rubrics.
- Total of 4 reviews per semester will be carried out to evaluate the progress of the project.
- During each review, team has to present the project work carried out (Viva-voce or PPT).
- Final evaluation will be done by external examiners during End semester assessment as per the evaluation scheme.

Phases of senior design project:

Sl. No	Phases	Reviewed	Activities
1	Review-1	By Review committee	Need analysis, Detail Review of literature, Objectives, Overall plan of work.
2	Review-2	By Project Guide	Development of protocols, Standardization and screening.
3	Review-3	By Project Guide	Design of experiments, conduct of experiments, Initial experimental data.
4	Review-4	By Review committee	Final experimentation, Data interpretation and analysis, Conclusion.

Program: Biotechnology		
Course Title: Downstream Processing Technology Lab		Course Code: 15EBTP401
L-T-P: 0-0-1	Credits: 1.0	Contact Hours: 02 Hours/Week
ISA Marks: 80	ESA Marks: 20	Total Marks: 100
Teaching Hours: 24	Examination Duration: 03 Hours	
<p>List of Experiments</p> <ol style="list-style-type: none"> 1. Cell disruption technique: Sonication. 2. Solid-liquid separation method: Filtration. 3. Solid-liquid separation methods: Centrifugation. 4. Product enrichment operations: Two – phase aqueous extraction. 5. Isoelectric precipitation of proteins 6. Membrane Separation methods: Tangential Flow Filtration 7. Chromatography techniques: Gel exclusion chromatography 8. Chromatography techniques: Ion exchange chromatography 9. Determination of protein molecular weight: SDS-PAGE 10. Estimation of metabolite using high performance liquid chromatography 		
<p>Text Books/ Reference Books:</p> <ol style="list-style-type: none"> 1. Bioseparations: Principle & Technique; Shiv Shankar B.; PHI LEARNING PRIVATE LIMITED;2009 2. Bioseparations: Downstream Processing for Biotechnology; Paul A. Belter E. L. Cussler Wei-Shou Hu; WILEY INDIA PVT. LTD.-NEW DELHI; 2011 3. Separation Processes in Biotechnology; Juan A. Asenjo; CRC Press (28 June 1990). 4. Protein Purification : Principles and Practice; Robert K Scopes;Springer; 2010 December 		

1.1.3. Number of courses having focus on employability/ entrepreneurship/ skill development during the year.

Year of offering: 2021-22
Batch- 2018-22 (8th semester)

Program: Biotechnology		
Course Title: Biological Data Analysis		Course Code: 18EBTE402
L-T-P: 3-0-0	Credits: 3.0	Contact Hours: 03 Hours/Week
ISA Marks: 50	ESA Marks: 50	Total Marks: 100
Teaching Hours: 40	Examination Duration: 03 Hours	
Unit I		
<p>1.Introduction to Basic statistics: Strategy of Experimentation, History of the Design of Experiments, Basic Principles of DOE: Randomization, Replication, Blocking, Multi-factor Designs, Confounding; Steps for Planning, Conducting and Analyzing an Experiment, Typical applications of Experimental design, Basic Principles, Guidelines for Designing, Concepts of random variable, probability, density function, cumulative distribution function. Concept of confidence level. Statistical Distributions: Normal, Log Normal & Weibull distributions. Hypothesis testing, Probability plots. 04 Hours</p>		
<p>2. Screening Design: Introduction, Terminology: factors, levels, interactions, treatment combination, Orthogonal array, PB design, analysis of PD design, Numericals. 05 Hours</p>		
<p>3.Full Factorial Design: Basic Definitions and Principles, The Advantage of Factorials, The Two-Factor Factorial Design, Statistical Analysis of the Fixed Effects Model, Model Adequacy Checking, Estimating the Model Parameters, Concept of the General Factorial Design, 2^k Factorial Design, The 2^2 Design, The 2^3 Design, The General 2^k Design. 07 Hours</p>		
Unit II		
<p>4. Response surface methods: Introduction, Central composite design, Box Behnken design, importance of counter and surface plots. 05 Hours</p>		
<p>5. R Programming Basics: Overview of R programming, Environment setup with R Studio, R Commands, Variables and Data Types, Control Structures, Vectors, Factors, Functions, Matrices, Arrays and Lists. 06 Hours</p>		

6. Interfacing:

Interfacing R to other languages, Parallel R, Basic Statistics: Linear Model, Generalized Linear models, Non-linear models, Time Series, Autocorrelation and Clustering. **05 Hours**

Unit III

7. Introduction to Bioconductor for Sequence Data:

Sequencing Resources, Ranges Infrastructure, DNA /amino acid sequence from FASTA files, Reads from FASTQ files, Aligned Reads from BAM files, Called Variants from VCF files, Genome Annotations from BED, WIG, GTF files. **04 Hours**

8. Biological Data Analysis:

Preparing count matrices, The DESeq, DataSet, sample information, and formula design, exploratory analysis and visualization, Differential expression analysis, Plotting results, Annotating and exporting results **04 Hours**

Text Books:

1. R for Everyone: Advanced Analytics and Graphics: by Jared P. Lander Addison Wesley Data & Analytics Series, 2013.
2. Design and analysis of experiments” by D.C. Montgomery, 7th edition John Wiley and sons, NewYork

Reference Books:

1. A Little Book of R for Bioinformatics: by Avril Coghlan, Release 0.1
2. Das. M.M. and Giri N.C. : - Design and Analysis of Experiments

Scheme for End Semester Assessment (ESA)

UNIT	8 Questions to be set of 20 Marks Each	Chapter numbers	Instructions
I	3 Questions to be set of 20 Marks Each	1, 2,3	Solve Any 2 out of 3
II	3 Questions to be set of 20 Marks Each	4,5,6	Solve Any 2 out of 3
III	2 Questions to be set of 20 Marks Each	7,8	Solve Any 1 out of 2

Program: Biotechnology		
Course Title: Bio-business & Entrepreneurship		Course Code: 20EBTE402
L-T-P: 3-0-0	Credits: 3.0	Contact Hours: 3 hours/week
ISA Marks:50	ESA Marks:50	Total Marks:100
Teaching Hours:40	Examination Duration:3 hrs	
Unit-I		
1. Entrepreneurship		
<p>Concept of Entrepreneurship - Development of Entrepreneurship; Stages in entrepreneurial process; Role of entrepreneurs in Economic Development; Characteristics of successful Entrepreneur, Classification of Entrepreneurs, Myths of Entrepreneurship, Entrepreneurial Development models, Entrepreneurial development cycle, Problems faced by Entrepreneurs. Entrepreneurship in India: Small scale industries: Definition; Characteristics; Need and rationale. Objectives; Scope; Introduction to bio-business, from the Indian context, SWOT analysis of bio-business.</p>		
10 hours		
2. Social Responsibilities of Business		
<p>Meaning of Social Responsibility, Social Responsibilities of Business towards Different Groups, Social Audit, Business Ethics and Corporate Governance Institutional Support for Business Enterprises: Introduction, Policies & Schemes of Central Level Institutions, State Level Institutions.</p>		
05 hours		
Unit-II		
3. Entrepreneurship opportunity in biotechnology		
<p>Business opportunity, Essential requirement, marketing strategies, schemes, challenges and scope-with case studies on entrepreneurship opportunities in different domains of Biotechnology (Agri biotechnology, industrial Biotechnology, food biotechnology, Biopharma, Nutraceuticals. etc).</p>		
05 hours		
4. Project management, technology management and startup schemes		
<p>Meaning of Project; Project Identification; Project Selection; Project Report; Need and Significance of Report; Contents; Formulation; Guidelines by Planning Commission for Project report; Network Analysis; Errors of Project Report; Project Appraisal. Identification of business opportunities: Market Feasibility Study; Technical Feasibility Study; Financial Feasibility Study & Social Feasibility Study.</p>		
10 hours		
Unit-III		
5. Startup Schemes		
<p>Building Biotech business challenges in Indian context-biotech partners (BIRAC, DBT, Incubation centers. Etc.), operational biotech parks in India. Indian Company act for Bio business-schemes and subsidies. Patent expiry and Entrepreneurship opportunity, Principles of Technology leasing, licensing and transfer, Business incubation support schemes, Successful startups-case study.</p>		

05 hours

6. Funding Opportunities

Startup schemes in Indian government Sources of Funding for startups. Crowd funding, Self-funding, Venture Capitalists, Angel Investment. Banking support for startup business. Types of companies: Sole proprietorship company, Partnership company, Private Limited, Limited company etc.

05 hours

Text Books:

1. Principles of Management – P. C.Tripathi, P.N. Reddy – Tata McGraw Hill,
2. Entrepreneurship Development - S.S.Khanka - S.Chand & Co.
3. Project Management by Sahni, Ane Books.

Reference books

1. Management Fundamentals - Concepts, Application, Skill Development - Robers Lusier - Thomson
2. Project Management for Business & Technology, Nicholas, PHI.

Scheme for End Semester Assessment (ESA)

UNIT	8 Questions to be set of 20 Marks Each	Chapter numbers	Instructions
I	3 Questions to be set of 20 Marks Each	1,2	Solve Any 2 out of 3
II	3 Questions to be set of 20 Marks Each	3,4	Solve Any 2 out of 3
III	2 Questions to be set of 20 Marks Each	5,6	Solve Any 1 out of 2

Program: Biotechnology		
Course Title: Genomic Data Analysis		Course Code: 21EBTE402
L-T-P: 3-0-0	Credits: 03	Contact Hours: 03 Hours/Week
CIE Marks: 50	SEE Marks: 50	Total Marks: 100
Teaching Hours: 40	Examination Duration: 03 Hours	
Unit I		
<p>1. Introduction to Genomics and Data science: Genomics- Introduction, Structure of prokaryotic and eukaryotic genome, Central dogma, Genome analysis– Introduction, necessity and tools of genome analysis Genome Sequencing methods, Next Generation Sequencing, Introduction to Data Science: Data, Information, Data science, Data science process, Data analytics process, exploratory data analysis, data types and plotting. 5 Hours.</p>		
<p>2. Python for genomic data science:Part I Introduction, Installation, Jupyter note book, types and sequence, python numbers and strings, variables, handling numerical data, python objects, data structure. 10 Hours</p>		
Unit II		
<p>3. Python for genomic data science:Part II Ifs and loops, python functions, library, communication with outside, modules and package. 5 Hours</p>		
<p>4. Genomic analysis: Algorithms Introduction, DNA as string, manipulation of DNA, Dynamic programming: Local and Global alignment, BLAST algorithm, DNA assembly. 5 Hours</p>		
<p>5. Biopython Introduction, working with sequence, sequence objects, sequence alignment, reading genomic sequence files. 5 Hours</p>		
Unit III		
<p>6. Introduction to Galaxy software Introduction, galaxy platform, working with genomic data, creation of work flow, annotation, sharing and publishing of genomic data, Genome and RNA sequence analysis. 5 Hours</p>		
<p>7. Introduction to Bioconductor for Sequence Data Sequencing Resources, Ranges Infrastructure, DNA /amino acid sequence from FASTA files, Reads from FASTQ files, Aligned Reads from BAM files, Called Variants from VCF files, Genome Annotations from BED, WIG, GTF files. 5 Hours</p>		

Text Books

1. Bioinformatics with Python Cookbook, Second Edition: Tiago Antao, Ingram short title; 2nd edition (1 January 2018), ISBN-13 : 978-1789344691.
2. R Bioinformatics Cookbook, Dan MacLean, Packt Publishing Limited (11 October 2019), ISBN-13 : 978-1789950694.
3. Hahne F, Huber W, Gentleman R, Falcon S. Bioconductor Case Studies. Springer Publishing Company, 2008. Mathur SK.

Reference Books

1. Lee JK. Statistical Bioinformatics: A Guide for Life and Biomedical Science Researchers. Hoboken, N.J.: WileyBlackwell, 2010.
2. Statistical Bioinformatics with R. Academic Press, 2010.
3. Genome Data Analysis, Ju Han Kim, 2019, Springer Singapore

Scheme for End semester examination (ESA)

UNIT	8 Questions to be set of 20 Marks Each	Chapter numbers	Instructions
I	3 Questions to be set of 20 Marks Each	1, 2	Solve Any 2 out of 3
II	3 Questions to be set of 20 Marks Each	3,4,5	Solve Any 2 out of 3
III	2 Questions to be set of 20 Marks Each	6,7	Solve Any 1 out of 2

Program: Biotechnology		
Lab Title: Capstone Project		Lab Code:20EBTW402
L-T-P: 0-0-11	Credits: 11	Contact Hours: 33 hrs/week
ISA Marks: 50	ESA Marks: 50	Total Marks: 100
Teaching Hours: 33 hrs/week	Examination Duration: 03 hours	

Guidelines:

- Capstone Project to be carried out in a group of maximum 4 students.
- Every student needs to maintain laboratory work book which should contain the details of all the work carried out in the laboratory.
- Entries to be done in log books for instrument usage.
- Timely report submission to the coordinator.
- Requisitions for chemicals and glassware's to be provided in advance for the project work

Review committee:

- Review committee is formed by the project coordinator taking into consideration that review committee consists of faculty experts from all domains. Review committee consists of the guide of the respective project group also.

Reviews:

- Continuous internal evaluation will be done by the respective guides/review committee as per the rubrics.
- Total of 4 reviews per semester will be carried out to evaluate the progress of the project.
- During each review, team has to present the project work carried out (Viva-voce or PPT).
- Final evaluation will be done by external examiners during End semester assessment as per the evaluation scheme.

Phases of Capstone project:

SI. No	Phases	Reviewed	Activities
1	Review-1	By Review committee	Need analysis, Detail Review of literature, Objectives, Overall plan of work.
2	Review-2	By Project Guide	Development of protocols, Standardization and screening.
3	Review-3	By Project Guide	Design of experiments, conduct of experiments, Initial experimental data.
4	Review-4	By Review committee	Final experimentation, Data interpretation and analysis, Conclusion.

Civil Engineering B.E. (Civil Engineering)
7th & 8th Semester
Curriculum Structure & Syllabus
2018 – 22 Batch
(2018-19 Admission)

Professor & Head
School of Civil Engineering
KLE Technological University
Hubballi.

IV Year Bachelor of Engineering (Civil Engineering)

Curriculum Structure – 2016 Scheme

VII Semester B.E.

No.	Code	Course	Category	L-T-P	Credits	Contact Hours	ISA Marks	ESA Marks	Total Marks	Exam Duration
1	15ECVC401	Design of Steel Structures	PC	3-0-0	3	3	50	50	100	3 hours
2	15ECVE4**	Program Elective -2	PE	3-0-0	3	3	50	50	100	3 hours
3	15ECVE4**	Program Elective -3	PE	3-0-0	3	3	50	50	100	3 hours
4	15ECVE4**	Program Elective -4	PE	3-0-0	3	3	50	50	100	3 hours
5		Design Project	PW	6-0-0	6	3	50	50	100	3 hours
6	15ECVP401	Design Studio - Steel and RC Structures	PC	0-0-2	2	3	50	50	100	3 hours
7	15ECVE4**	Program Elective -5	PE	3-0-0	3	3	50	50	100	3 hours
8	15EHSN401	CIPE /EVS	HS	-	Audit	3	50	50	100	3 hours
Total					21-0-2	23				

Note: L – Lecture, T – Tutorial, P – Practical, ISA – In Semester Assessment, ESA – End Semester Assessment, PC-Programme Core,

BS – Basic Science, ES- Engineering Science, OE - Open Elective, PE - Program Electives, PW – Project

Note: Student has to take two elective subjects from major Vertical and one elective subject from minor vertical.

Program Electives -2, 3 and 4

Vertical 1 - Structural Engineering	
15ECVE401	Design of Sub-structures
15ECVE402	Advanced RCC
15ECVE403	FEM Analysis

Vertical 2 - Construction Engineering & Management	
15ECVE404	Horizontal and Vertical Construction Methods
15ECVE405	Construction Economics & Management
15ECVE406	Construction Quality Management

Vertical 3 - Environmental Engineering	
15ECVE407	Solid Waste Management
15ECVE408	Advanced Waste Water Treatment
15ECVE409	Air Pollution

VIII Semester B.E.

No.	Code	Course	Category	L-T-P	Credits	Contact Hours	ISA Marks	ESA Marks	Total Marks	Exam Duration
1	15ECVE4**	Program Elective -6	PE	3-0-0	3	3	50	50	100	3 hours
2	15ECVE4**	Open Elective - 1	OE	3-0-0	3	3	50	50	100	3 hours
5	15ECVW402	Project	PW	0-0-11	11	3	50	50	100	3 hours
		Total		6-0-11	17					

Note: L – Lecture, T – Tutorial, P – Practical, ISA – In Semester Assessment, ESA – End Semester Assessment, PC-Programme Core,

BS – Basic Science, ES- Engineering Science, OE - Open Elective, PE - Program Electives, PW – Project

Open Elective – 1

15ECVO401- Nano Composite Materials	15ECVO402- Optimization Techniques
-------------------------------------	------------------------------------

Program Electives -5 and 6

Vertical 1 - Structural Engineering	
15ECVE401	Design of Sub-structures
15ECVE402	Advanced RCC
15ECVE403	FEM Analysis

Vertical 2 - Construction Engineering & Management	
15ECVE404	Horizontal and Vertical Construction Methods
15ECVE405	Construction Economics & Management
15ECVE406	Construction Quality Management

Vertical 3 - Environmental Engineering	
15ECVE407	Solid Waste Management
15ECVE408	Advanced Waste Water Treatment
15ECVE409	Air Pollution

Course Title: Design of Steel Structures

Course Code: 15ECVC401

L-T-P: 3-0-0

Credits: 3

Contact Hours: 3 Hrs/ week

ISA Marks: 50

ESA Marks: 50

Total Marks: 100

Teaching Hours: 40

Examination Duration: 3 Hrs

Unit I

1. Introduction

Advantages and disadvantages of Steel structures, Loads and load combinations, Wind load calculation, Wind speed, Design wind speed, Design wind pressure. Structural forms, Design concepts. IS code provisions. Fire resistance and ductility of steel. ~~Introduction to working stress method.~~ **03 hrs**

2. Structural Fasteners

Bolted and welded connections, Strength of bolt and bolted joint. Design of bolted connections. Bracket connections. Welded connections, fillet and Butt welds, strength of a weld, Bracket connections. **07 hrs**

3. Design of Tension Members

Axially loaded tension members and their connections, design of lug angles, Design of truss ties and joints. **05 hrs**

Unit II

4. Design of Compression Members

Angle struts, Columns including built up sections, Laced and Battened systems. Column splicing, column bases- simple slab base, gusseted base. **09 hrs**

5. Design of Flexural Members

Simple and built up sections. Laterally supported and unsupported compression flange. Web crippling and web buckling. **06 hrs**

6. Design of Truss

~~Wind load, dead load and other loads wind pressure, calculation of loads on nodes, design of members of the roof Truss, design, Design of purlins~~ **05 hrs**

6. Design of Welded Plate Girders

Introduction, Design of Plate Girders (without intermediate stiffeners) **05 hrs**

7. Design of Gantry Girders

Introduction, Design of Gantry Girders **05 hrs**

Text Book

1. Bhavikatti, S.S, *Design of Steel Structures*, 5ed., New Age International , 2017
2. Duggal S.K, *Design of Steel Structures*, 2ed., Tata McGraw Hill Education Pvt. Ltd., New Delhi, 2016.

Reference Books:

1. Subramanian, N., *Design of Steel Structures*, 1ed., Oxford University Press, New Delhi, 2014.
2. Ramachandra & Virendra Gehlot, *Design of Steel Structures*, 12ed., Scientific Publishers, New Delhi, 2009.

3. P C Verghese, "Limit State Design of Reinforced Concrete", PHI Publications, New Delhi
4. Dayarathnam P, "Design of Steel Structures", S Chand and Company Ltd., New Delhi.

IS Codes

1. IS-800: 2007 *Guidelines for Design of Structural Steel.*
2. IS:875 (Part 3) 1987 *Code of Practice for Design Loads (Other than Earthquake) for Buildings and Structures : Wind Loads.*

Course Title: Design of Sub-structures

Course Code: 15ECVE401

L-T-P: 3-0-0

Credits: 3

Contact Hours: 3 Hrs/ week

ISA Marks: 50

ESA Marks: 50

Total Marks: 100

Teaching Hours: 40

Examination Duration: 3 Hrs

Unit I

1. Soil Exploration

Subsurface exploration programme for civil engineering projects. Interpretation of soil parameters. Tests on disturbed and undisturbed soil samples, Soil exploration report. **02 hrs**

2. Shallow Foundations

Design Criteria. Types of shallow foundations. Bearing capacity theories. Bearing capacity from field tests. Use of different foundation models. Design of individual and combined footings. Design of raft foundations - Conventional methods. Modulus of subgrade reaction. Beams on elastic foundations. Analysis of footings by Finite Difference. **07 hrs**

3. Pile Foundations

Load carrying capacity of pile. Design of pile and pile groups. Batter piles and under reamed piles. Design of pile cap. Design of axially and laterally loaded piles. **06 hrs**

Unit II

3. Drilled Piers and Caissons

Construction, advantages and disadvantages of drilled piers. Design of open, pneumatic and floating caissons. Advantages and disadvantages of floating caissons. **06 hrs**

4. Well Foundation

Different shapes and characteristics of wells. Components of well foundation. Forces acting on well foundation. Sinking of wells. Causes and remedies of tilts and shifts. **05 hrs**

5. Foundations on Expansive Soils

Definition, Identification, Structure, Index properties of expansive soils, Swell potential and Swell pressure, Free swell, CNS layer, foundation treatment for structures in expansive soil. **05 hrs**

Unit III

6. Machine Foundations

Basic terminologies. Design criteria for machine foundations. Vibration analysis. Methods of analysis. Determination of soil parameters. Foundations for reciprocating machines. Foundations for impact type of machines. Vibration isolation. **05 hrs**

7. Foundations for Special Structures

Foundations for tall structures - Water tanks, Chimneys, Antenna towers and Radar units.

04 hrs

Text Books

1. Bowles. J. E, *Foundation analysis and design*, 5ed, McGraw-Hill Company, Inc, New York, 2012.
2. Das. B.M, *Principles of Foundation Engineering*, 8ed., Thomson Business Information India (P) Ltd., India, 2014.
3. Murthy V.N.S., *Soil Mechanics and Foundation Engineering*, 4ed., UBS Publishers and Distributors, New Delhi, 2016.
4. Swami Saran, *Analysis and Design of Substructures: Limit State Design*, 2ed, oxford and IBH publishing co. Pvt. Ltd., 2006.

Reference Books:

1. Ghosh K.M., *Foundation Design in Practice*, PHI Learning Pvt. Ltd., New Delhi, 2009.
2. Nainan Kurian., *Modern Foundations: An Introduction to Advanced Techniques*, Tata McGraw Hill Education Pvt. Ltd, New Dehli, 1982.
3. Som N. N., Das S. C., *Theory and Practice of Foundation Design*, PHI Learning Private Limited, New Delhi, 2009.
4. Srinivasulu, P. and Vaidyanathan, C.V., *Hand Book of Machine Foundations*, 1ed, Tata McGraw Hill Education Pvt. Ltd, New Dehli , 2002.
5. Tomlinson, M.J., *Pile Design and Construction Practice*, 6ed, CRC Press, 2014.
6. Winterkorn, H. F. and Fang H. Y., *Foundation Engineering Hand Book*, 2ed, Van Nostrand Reinhold Company, 1991.
7. Sharat Chandra Gupta, *Raft Foundations Design and Analysis with a Practical Approach*, New Age International (P) Ltd., Publishers, 1997.

IS Codes:

1. IS 2911 (Part 1/Sec 3) : 2010 - *Design And Construction Of Pile Foundations*
2. IS: 2950 (Part I) -1981 (Reaffirmed 2008) - *Code Of Practice For Design And Construction Of Raft Foundations*

Course Title: Advanced RCC Structures

Course Code: 15ECVE402

L-T-P: 3-0-0

Credits: 3

Contact Hours: 3 Hrs/ week

ISA Marks: 50

ESA Marks: 50

Total Marks: 100

Teaching Hours: 40

Examination Duration: 3 Hrs

Unit I

1 Design of Combined and Raft Footing

Design of Combined footings: rectangular and trapezoidal Combined Footings. 10 hrs
Design of raft footing as per IS:456:2000 Guidelines

2. Design of Special type of slabs

Introduction to different types of slab system, Design of grid slab, Yield line analysis of slabs. 10 hrs

Unit II

4. Retaining Walls 07 hrs

Design of Cantilever and Counter-fort type of retaining walls.

5.Design of continuous beams 06 hrs

Bending moment envelopes moment redistribution as per IS Code provisions.

Unit III

6. Design of Water tanks 07 hrs

Design of circular and rectangular water tanks, resting on ground and underground overhead water tanks and design of Intz tank.

Text Books

1. Jain, A.K., *Limit State Method of Design*, 7ed., Nemichand and Bros., Roorkee, 2012.
2. Punmia B.C., Ashok Kumar Jain, and Arun Kumar Jain, *Limit State Design of Reinforced Concrete*, Laxmi Publications Pvt. Ltd., New-Delhi-2016.

Reference Books:

1. Bhavikatti S.S, *Advanced RCC Design (RCC Vol-II)*, New Age International Publishers, New Delhi, 2008.
2. Krishnaraju, N., *Design of Reinforced Concrete Structures (IS: 456 – 2000)*, 3ed., CBS Publishers, New Delhi, 2016.
3. Robert Park & Thomson, *Reinforced Concrete*, John Wiley & Bros Pvt. Ltd, 1975
4. Unnikrishnan Pillai S. and Devdas Menon, *Reinforced Concrete Design Third Edition*, Tata McGraw Hill Education Pvt Ltd., New-Delhi-2017.
5. P-C Varghese, *Limit State Design of Reinforced Concrete Vol-II*, Prentice Hall of India

(P) Ltd, New Delhi.

6. Vazirani V N & M M Ratwani, Analysis of Structures- Vol-II, Khanna Publishers, New Delhi.
7. IS:456-2000, *Plain and Reinforced Concrete – Code of Practice (Fourth Revision)*, BIS, New Delhi, 2000
8. SP 16: *Design Aids for Reinforced Concrete to IS 456:1978.*

Course Title: Design Studio – Steel and RC Structures **Course Code: 15ECVP401**

Credits: 2 **Contact Hours: 6 Hrs/ week**

ESA Marks: 80 **Total Marks: 100**

Examination Duration: 3 Hrs

Unit – I

- a. RCC Detailing 20 hrs
- b. Drawing and detailing of beams (Simply supported and Continuous beam), slab (One way and two way), column, footing (Isolated and combined) and stairs (Dog legged)
- c. Retaining walls – cantilever and counter fort retaining walls
- d. Water tanks – Underground, Ground level, Overhead (Intz tank)
- e. Portal frame – Single bay

Unit – II

- 2. Drawings to be prepared for given structural details 12 hrs
 - f. Connections: Bolted and welded, beam-beam, Beam-column, seated, stiffened and un-stiffened.
 - g. Columns: Splices, Column-column of same and different sections. Lacing and battens
 - h. Column Bases: Slab base and gusseted base.
 - i. Roof Trusses: At supports and different nodes.

Text Books

1. Bhavikatti, S.S., *Design of Steel Structures by Limit State of Method – As per IS 800-2007*, I.K. International Publishing House Pvt. Ltd., New Delhi, 2009
2. Ramachandra, *Design of Steel Structures*, Vol- 1 & 2, Standard Book House, New Delhi, 2009.
3. Subramanian, N., *Design of Steel Structures*, Oxford University Press, New Delhi, 2008.
4. Kazimi and Jindal, *Design of Steel Structures*, 2ed., Prentice Hall of India, New Delhi, 2000.

References

1. Arya and Ajmani, *Design of Steel Structures*, Nem Chand Bros, Roorkee, 1977.
2. Negi, L.S., *Design of Steel Structures*, Tata McGraw Hill Publishers,

2004.

IS Codes:

1. SP 6 (Part 1) Year: 1984 *Handbook for structural engineers - Structural steel sections*
2. SP: 34 Year 1987 *Handbook on Concrete Reinforcement and Detailing*
3. IS:800-2007 *Code of Practice for general Construction in Steel*

Course Title: Finite Element Methods

Course Code: 15ECVE403

L-T-P: 3-0-0

Credits: 3

Contact Hours: 3 Hrs/ week

ISA Marks: 50

ESA Marks: 50

Total Marks: 100

Teaching Hours: 40

Examination Duration: 3 Hrs

Unit I

1. Introduction to Finite Element method.

Introduction, Basic concepts on finite element analysis, Introduction to nodes, elements, and shape functions, Steps in Finite Element Analysis, Key concepts and Terminologies. **05 hrs**

2. Element Properties.

Natural Coordinates, Triangular Elements, Rectangular Elements, Introduction to Weighted integrals, Integration by parts-Review, Gradient and Divergence Theorems, Functionals. **05 hrs**

3. Finite Element Formulation Technique.

Virtual Work and Variational Principle (Rayleigh-Ritz Method), Weighted Integrals and Weak Formulation, Different types of weighted integral methods such as Galerkin Method, Petrov-Galerkin Method, Collocation Method and Method of Least-squares. **05 hrs**

Unit II

4. Second Order Boundary Value Problem.

FEA formulation of 2nd order boundary value problem, Development of element level equations, Assembly of element level equations and implementation of boundary conditions, Assembly process and Connectivity matrix. **08 hrs**

5 Applications of Second Order Boundary Value Problem.

Radially symmetric problems, One-dimensional heat transfer problem, Euler-Bernoulli beam, Shear deformable beam, Eigen value problems, Introduction to time dependant problems. **10 hrs**

Unit III

6. FEM Program

Structure of FEM program for FEM Analysis, Description of different modules in FEM software (ABAQUS), Introduction to different types of analysis, Pre and post processing. Comparison of manually solved problems with software results. **07 hrs**

Text Books

1. Reddy J.N., *An Introduction to Finite Element Method*, 3ed., McGraw- Hill Publishing Company Inc, New York, 2017.
2. Krishnamoorthy C. S., *Finite Element Analysis*, Tata McGraw-Hill Education Pvt. Ltd, New Delhi, 2004.

Reference Books:

1. Rajasekaran, S., *Finite Element Analysis in Engineering Design*, S. Chand Group, 2006.
2. Pandit G.S. and Gupta, S.P., *Structural Analysis, A Matrix Approach*, 2ed., Tata McGraw- Hill Education Pvt. Ltd, New Delhi, 2008.
3. Cook R.D., Malkus D.S., Plesha M.E. and Witt R.J. *Concepts And Applications Of Finite Element Analysis*, 4ed., John Wiley and Jous, Inc., 2013.
4. Bathe K.J., *Finite Element Procedures*, Klaus-Jürgen Bathe; 2ed., 2014.
5. Bhavikatti S.S., *Finite Element Analysis*, New Age International Publication Pvt. Ltd., New Delhi, 2010.
6. Daryl L. Logan., *A first course in the Finite Element Method*, 5ed, Cengage Learning, 2010.
7. Tirupathi R. Chandrupatla and Ashok D. Belegundu, *Introduction to Finite Elements in Engineering*, 4ed, Pearson, 2011

Course Title: Horizontal and Vertical Construction Methods **Course Code: 15ECVE405**

L-T-P: 3-0-0 **Credits: 3** **Contact Hours: 3 Hrs/ week**

ISA Marks: 50 **ESA Marks: 50** **Total Marks: 100**

Teaching Hours: 40 **Examination Duration: 3 Hrs**

Unit I

1. Planning for earthwork construction

Planning, Graphical presentation of Earthwork, Earthwork quantities, Mass diagram and its applications, Pricing of earthwork operations. **04 hrs**

2. Compaction and Stabilization Equipment

Compaction of soil and rock, Types of compaction equipment, roller production estimating, Dynamic compaction, Soil stabilization, stabilizing soils with lime, Cement-soil stabilization. **05 hrs**

3. Excavators and loaders **06 hrs**

Hydraulic Excavators, selection of front shovels, calculating shovel production, height of cut effect on shovel production, angle of swing effect on shovel production, Loaders – introduction, Loader buckets/attachments, operating specifications, Loader production rates, calculating wheel loader production, Calculating track loader production, Loader safety.

ISA Marks: 50

Unit II

4. Drilled Shaft Foundations

Introduction, Construction of drilled shafts – dry method of construction, casing method of construction, wet construction method, Installation of casings, Steel cages, Placement of concrete, Dewatering, open dewatering systems, deep well systems, well point systems – Types, techniques, Basement waterproofing systems. **05 hrs**

5. Formwork Systems **06 hrs**

Introduction, formwork materials, shores and scaffolding, Vertical formwork systems – Conventional wall/columns forming systems, Modular panel column form, adjustable wraparound column forms, circular steel forms for round columns, wall panel system, single sided wall formwork, formwork ties, Horizontal formwork systems – conventional wood form and metal systems, cup-lock type scaffolding system, slab flex system, tunnel form, flying formwork system, crane-jumped formwork, automatic climbing formwork, self-rising core system, Monolithic Formwork System.

6. Concrete and Conveying Systems **06 hrs**

Introduction, Concrete – Mixers, Concrete plants, Pre-tensioning and Post tensioning, Transporting and handling – Concrete chute, concrete mixer with lift, concrete skip, truck mixer concrete pumps, concrete belt conveyors, concrete pump truck, trailer pump and pipeline with tower-mounted boom, trailer mounted

pumps, pipeline system, mobile concrete placing booms, finishing.

Unit III

7. Cranes

Major cranes types, Mobile cranes, Crawler cranes, Telescoping-boom truck-mounted cranes, Lattice-boom truck-mounted cranes, Rough-terrain cranes, modified cranes for heavy lifting, crane booms, lifting capacities of cranes, Rated loads for lattice and telescopic boom cranes, Tower cranes – classifications, operation, Tower crane selection, Rated loads for tower cranes, rigging, slings, safety.

05 hrs

8. Modular Construction Practices:

03 hrs

Introduction to Modular Construction, Modular coordination, Modular Standardization, Modular System Building, Limitation and Advantages of Modular Construction

Text Books

1. S. C. Sharma, *Construction Equipment and Management*, Khanna Book Publications, 2016
2. Peurifoy, *Construction Planning, Equipment & Method*, 7ed., Tata McGraw Hill Education Pvt. Ltd., New Delhi, 2010.
3. Basem M, *Construction Technology for High-rise Buildings-Handbook*, 2014.

Reference Books:

1. Stephens W. Nunnally, *Managing Construction Equipment*, 2ed, Pearson Publications, USA, 2000.
2. Gupta B. L., Amit Gupta, *Construction Management and Machinery*, 5ed, Standard Publications, New Delhi, 2015.

Course Title: Advanced Project Management

Course Code: 21ECVE404

L-T-P: 3-0-0

Credits: 3

Contact Hours: 3 Hrs/ week

ISA Marks: 50

ESA Marks: 50

Total Marks: 100

Teaching Hours: 40

Examination Duration: 3 Hrs

Unit I

1. Operation Research in Management

Introduction, definition, phases, scope, characteristics, limitations of operational research, and management decision making. Methodology and applications of operational research. Linear programming, applications, formulations of LP models. Graphical methods, Simplex method, Transportation Models-Balanced & Un-balanced type of problems

10 hrs

2. Cost Control

Introduction, project costs – direct and indirect, cost optimization through networks, use of simplex and dual simplex methods of linear programming to optimize construction costs, project cost formulation.

05 hrs

Unit II

3. Construction Site Layout

Introduction, Objectives of preparing a site layout, Factors affecting the site layout, documentation study before site layout, Storing and stacking of materials on site, Location of machinery and equipment, Stack size of common building materials, Preparation of a site layout.

05 hrs

4. Construction Disputes and their Settlements

Introduction, development of disputes, types of disputes, modes of settlements, settlement by direct negotiations between the client and contractor, settlement through arbitration, arbitration act 1940, powers of an arbitrator as per 1940 act, settlement through courts.

05 hrs

5. Risks and Insurance in Construction

Introduction, risk, risk identification in construction, risk analysis and evaluation process, response management process, insurance in construction, principles of insurance, project insurance, contractor's all risk insurance, fire policy, plant and machinery insurance, liquidity damages insurance, professional indemnity policy.

05 hrs

Unit III

6. Construction Safety Management

Introduction, evolution of safety, Accident causation theories, unsafe conditions and acts, health and safety act and regulations, role of safety personal, causes of accidents, principles of safety, safety and health management system.

05 hrs

KLE Technological University, Hubballi

7. Construction Labour and relevant Laws

Introduction, construction labour in India, payment of wages to labour, Labour Laws, payment of wages act 1936, minimum wages act 1948, workers compensation act 1923, contract labor act 1970, employees state insurance act 1948, bonus act, employee's provident fund act, trade unions and their role. **05 hrs**

Text Books

1. Kumar Neeraj Jha, *Construction Project Management: Theory and Practice*, 2ed., Edition, Pearson Publications, 2015.
2. S.C. Sharma, *Construction equipment and management*, new edition, 2019
3. P. Rama Murty, *Operations Research*, 2nd edition, 2007, New age international publishers

Reference Books:

1. P. Harris, *Planning and Scheduling Using MS Project 2010*.
2. Ursula Kuehn, *Integrated Cost and Schedule Control in Project Management*, 2ed., 2011.

Course Title: Construction Quality Management

**Course Code:
15ECVE406**

L-T-P: 3-0-0

Credits: 3

**Contact Hours: 3
Hrs/ week**

ISA Marks: 50

ESA Marks: 50

Total Marks: 100

Teaching Hours: 40

Examination Duration: 3 Hrs

Unit – I

1. Concept of Quality

Definition of Quality, Historical background of quality control, difference between Quality control and Quality Assurance (QA/QC). Total quality control (TQC) and Total Quality Management (TQM), Need for TQM in construction industry, TQM philosophy: Concept of Deming, Juran, Crosby, Imai, Ishikawa, Taguchi, Shingo philosophies. Models and frame works.

**04
hrs**

2. Quality Control Tools

Cause and Effect diagrams, Check sheets, Control charts, Data collection, Flow charts, Histograms, Pareto analysis, Pie charts, Run chart, Scatter diagrams and Control charts (Concepts and examples in construction projects) - problems, Quality functions deployment (QFD), Benchmarking.

**06
hrs**

3. Development of Human Resource and Quality Circles

Training and development, technical and managerial competencies necessary for achieving quality Cultural change, Innovation and learning, Leadership and commitment, Philosophy of quality circles, Organization of Quality Circles, Stages of Adoption, Areas of Interest to Quality circles, Essential Requirements for the success of circles, Gains from circles. Inspection reports, Monitoring and Control, 360 feedbacks for quality.

**05
hrs**

Unit – II

4. Study of ISO 9001- Quality System Standards.

Purpose of ISO Standards. Difference between ISO 9001 and ISO 9004. Certification process for ISO 9001 and ISO Certification, NABL certification. Certification bodies involved. Eight Principles of ISO-Basic meaning, Quality management system requirements.

**04
hrs**

5. Quality Management System Procedures

Introduction, procedure for management review, Format for writing procedures, Procedure for preparing Quality plans/ work Instructions, Contract review, Design control, Document and data control, Document numbering system, Change request, purchasing, control of customer supplied product, product identification and traceability, process control, inspection and testing, measuring and test equipments, the control of non-conforming product, corrective and preventive action, handling,

**09
hrs**

storage, packaging and delivery, control of quality records.

6. Work Instructions

Introduction -Document and Data Control, Material Procurement, Material Handling, Tendering and Estimating, Planning, Design, Training, Plant and Equipment, Bar Bending Schedule, Concrete Works, Earthworks and Compaction, Soil Investigation works, Survey works, Concrete Repair Works, Road Works, Painting Works, Water Proofing works, Drainage Works, Quality Assurance and Control, Patching and Transportation of Concrete.

03
hrs

Unit – III

7. Method Statement

Introduction, Concrete Works, Earthworks and Compaction, General Soil Investigation works, Survey works, Concrete Repair Works, Concrete Demolition Works, Road Works, Fencing works etc.

04
hrs

8. Job Description

Introduction, Job Description of: Managing Director, Project Manager, Site Manager, Site Engineer, QA/QC Engineer, Foreman, Typist/Clerk, Design Engineer, Planning Engineer.

03
hrs

9. Introduction to Six Sigma

Introduction, Definition of Six Sigma, evolution – Historical aspects, Six Sigma methodology, Leadership principles, Six Sigma team, Six Sigma in construction projects, Application of Six Sigma tool to RCC Work in building.

03
hrs

Text Books

1. Abdul Razzak Rumane, Quality Management Construction Projects, 2nd edition, CRC press, 2019
2. Rajendra Prasad, D.S., Quality Management System in Civil Engineering ISO 9001-2000, Sapna Book House, Bangalore, 2016
3. Besterfield Dale H, Total Quality Management, Pearson publications, 2018
4. Mohamed Zairi, Total Quality Management for Engineers, Woodhead publishing Limited. 2010
5. Craig Joseph Setter, Six Sigma, A complete step-by-step guide, Council of six sigma certification, 2018

Reference Books:

1. P.L.Jain, Quality Control and Total Quality Management, reprint. Tata McGraw Hill Publications, 2006
2. S. L. Tang, Construction Quality Management, 2005
3. Neville, A.M., *Properties of Concrete*, Pearson education India, 2012
4. Gary E. MacLean, Documenting Quality for ISO 9000 and other Industry Standards,,Tata McGraw-Hill Publishing Company Limited, 1993.
5. Yang, K. and El-Haik, B S., Design of Six sigma, Tata McGraw Hill,2009
6. Girdhar J. Gyani, Training Manual on ISO 9000-2000 and TQM, Raj Publishing House, 2006.
7. Feigenbaum Armand V., "*Total Quality Control*", McGraw Hill International Edition,1991
8. <http://gen.lib.rus.ec/book/bibtex.php?md5=057996440ECF0F315C3F127AD1B6C88D>
9. <http://gen.lib.rus.ec/book/bibtex.php?md5=22C6F54A31AF37AB6A4F718AE6F29522>

IS Codes:

1. IS: 456-2000, *Indian Standard Specifications for Plain and Reinforced Concrete Code of Practice*, 4th Revision, Bureau of Indian Standards.
2. IS: 383-1990, *Indian Standard Specifications for Coarse and Fine Aggregates from Natural sources for Concrete*, Bureau of Indian Standards.
3. ISO 9001-2015, *Quality Management System in Civil Engineering*
4. ISO 9004:2018, *Quality management — Quality of an organization — Guidance to achieve sustained success*

Course Title: Solid Waste Management

Course Code: 15ECVE407

L-T-P: 3-0-0

Credits: 3

Contact Hours: 3 Hrs/ week

ISA Marks: 50

ESA Marks: 50

Total Marks: 100

Teaching Hours: 40

Examination Duration: 3 Hrs

Unit I

1. Introduction

Solid waste -Definition, Land Pollution -scope and importance of solid waste management, functional elements of solid waste management. SOURCES: Classification and characteristics- municipal, hospital / biomedical waste, Quantity -Generation rate, methods. Latest Trends in SWM: (1) Legacy wastes and landfill mining: Risks and Rewards (2) Centralized and decentralized SWM approach in Villages, ULBs and Metro cities: Pros and Cons.

05 hrs

2. Collection and Transportation

Systems of collection, collection equipment, garbage chutes, transfer stations -bailing and compacting, route optimization

05 hrs

3. Processing Techniques

Components separation, volume reduction, size reduction, chemical reduction and biological processing

05 hrs

Unit II

4. Disposal Methods

Open dumping -selection of site, ocean disposal, feeding to hogs, composting, sanitary land. filling, merits and demerits. Construction/Demolition waste.

04 hrs

5. Incineration

Processes -3 T 's, factors affecting incineration process, incinerators -types, prevention of air pollution, pyrolysis.

04 hrs

6. Composting

Aerobic and anaerobic composting, factors affecting, composting, Indoor and Bangalore processes, mechanical and semi-mechanical composting processes. Vermi composting

05 hrs

Unit III

7. Sanitary Land Filling

Definition, methods, trench area, Ramp and pit method, site selection, basic steps involved, cell design, prevention of site pollution, leachate collection and control methods, gas collection systems.

07 hrs

8. Recycle and Reuse

Material and Energy Recovery Operations, Reuse In Other Industries, Plastic Wastes, Environmental Significance and Reuse

05 hrs

Text Books

1. George Tchobanoglous, Hilary Theisen and Vigil S. A., *Integrated solid waste management: engineering principles and management issues*, McGraw-Hill Inc,US, 1993.
2. Bhide A. D. and , Sundaresan B. B., *Solid Waste Management in Developing Countries*, Indian National Scientific Documentation Centre, 2010.
3. Ministry of Environment and Forests, Govt. of India, *The Municipal Solid Wastes (Management and Handling) Rules*, 2000.

Reference Books:

1. Joseph L. Pavoni, John E. Heer, D. Joseph Hagerty, *Solid Waste Management*, Van Nostrand Reinhold Co., 1973.
2. Howard S. Peavy, Donald R. Rowe, George Tchobanoglous, *Environmental Engineering*, McGraw-Hill Publishing Company Inc., New York, 2017.
3. Ramesha Chandrappa, Jeff Brown, *Solid Waste Management – Principles and Practice*, Springer Science & Business Media, 2012.

Text Books

1. George Tchobanoglous, Hilary Theisen and Vigil S. A., *Integrated solid waste management: engineering principles and management issues*, McGraw-Hill Inc,US, 1993.
2. Bhide A. D. and , Sundaresan B. B., *Solid Waste Management in Developing Countries*, Indian National Scientific Documentation Centre, 2010.
3. Ministry of Environment and Forests, Govt. of India, *The Municipal Solid Wastes (Management and Handling) Rules*, 2000.

Reference Books:

1. Joseph L. Pavoni, John E. Heer, D. Joseph Hagerty, *Solid Waste Management*, Van Nostrand Reinhold Co., 1973.
2. Howard S. Peavy, Donald R. Rowe, George Tchobanoglous, *Environmental Engineering*, McGraw-Hill Publishing Company Inc., New York, 2017.
3. Ramesha Chandrappa, Jeff Brown, *Solid Waste Management – Principles and Practice*, Springer Science & Business Media, 2012.

Text Books

1. George Tchobanoglous, Hilary Theisen and Vigil S. A., *Integrated solid waste management: engineering principles and management issues*, McGraw-Hill Inc,US, 1993.
2. Bhide A. D. and , Sundaresan B. B., *Solid Waste Management in Developing Countries*, Indian National Scientific Documentation Centre, 2010.
3. Ministry of Environment and Forests, Govt. of India, *The Municipal Solid Wastes (Management and Handling) Rules*, 2000.

Course Title: Advanced Waste Water Treatment **Course Code: 15ECVE408** hrs
L-T-P: 3-0-0 **Credits: 3** **Contact Hours: 3 Hrs/ week**
ISA Marks: 50 **ESA Marks: 50** **Total Marks: 100**
Teaching Hours: 40 **Examination Duration: 3 Hrs**

Unit I

1. Introduction

Wastewater Characteristics, Effluent Quality Standards, Receiving Stream Quality **03 hrs**

2. Primary Treatment- Screening, Grit removal, Neutralization, equalization, Sedimentation, Flotation (oil & grease removal); **06hrs**

3. Secondary Treatment- Fundamental concept of reactors: Mass balance relationships, analysis and descriptions of reactors- batch, completely mixed flow and plug flow oxygen requirement in aerobic process. **06hrs**

Unit II

4. Biological Treatment : Activated Sludge Process: Substrate Utilization and Biomass Growth, Kinetic Parameters, Process Description and its Modification, Process Design , Biofilm Process: Trickling Filter, Rotational Biological Contactor **10 hrs**

Aerated lagoons, oxidation pond-operation and maintenance

5. Advanced Treatment Processes- Chemical Coagulation, Carbon Adsorption, Phosphorus Removal, Nitrogen Removal (Nitrification/Denitrification), Media Filtration, UV Disinfection **06 hrs**

Unit III

6. Solids Handling Processes- Gravity Thickening, Flotation Thickening, Dewatering, Pressure Filtration, Stabilization, Aerobic and Anaerobic Digestion, Composting, Drying, Incineration, Landfilling, Land Application **09 hrs**

Text Books

1. Eddy and Metcalf, *Wastewater Engineering – Treatment and Reuse*, Tata McGraw Hill Education Pvt Ltd., New Delhi, 2003.
2. Modi, P.N., *Sewage Treatment and Disposal Engg.*, Standard Book House, New Delhi, 2000.
3. Howard S. Peavy, Donald R. Rowe, George Techno Bano Glous, *Environmental Engineering*, McGraw Hill International, 2010.

Reference Books:

1. Qasim S.R., Motley E. M., *Wastewater Treatment Plants – Planning, Design and Operation*, Prentice Hall, New Delhi. 2002.
2. Davis, M.L. and Cornwell, D.A., *Introduction to Environmental Engineering*, Tata McGraw Hill Education Pvt. Ltd., New Delhi, 2010
3. Hammer M.J., *Water and Waste Water Technology*, John Wiley and Sons, New York , 2000.

Course Title: Air Pollution

Course Code: 15ECVE409

L-T-P: 3-0-0

Credits: 3

Contact Hours: 3 Hrs/ week

ISA Marks: 50

ESA Marks: 50

Total Marks: 100

Teaching Hours: 40

Examination Duration: 3 Hrs

Unit I

1. Introduction

Definition -Classification and properties of Air pollutants, Primary and secondary Air pollutants, Concentrations of Air pollutants and sources. Behavior and Fate of Air Pollution: Chemical reaction in the Atmosphere, photochemical Smog. **05 hrs**

2. Effects of Air Pollution

On human health, Animals, Plant and properties, Major Episodes. **05 hrs**

3. Meteorology

Introduction -Meteorological Variables, Lapse Rate – Adiabatic - Dispersion, inversion, stability conditions, wind rose, general characteristics of stack plumes **05 hrs**

Course Title: Air Pollution

Unit II

4. Sampling and Analysis of Air Pollutants

Sampling and measurement of Gaseous and particulate pollutants, stack sampling, smoke and its measurements. **05 hrs**

5. Control of Air Pollutants

Control methods -Particulate emission control, gravitational settling chambers, cyclone separators, fabric filters, Electrostatic precipitators, wet scrubbers, control of gaseous emissions (Design not requires) **10 hrs**

Course Title: Air Pollution

Unit III

6. Air Pollution Due to Automobiles

Air pollution due to gasoline driven and Diesel driven engines, effects, control - direct and indirect methods. **02 hrs**

7. Global Environmental Issues

Acid rain, Green House effect, Global warming, Ozone layer Depletion. **04 hrs**

8. Environmental Impact Assessment

Environmental Impact Assessment in industrial plant locations and planning. Standards and legislation -Air quality and emission standards - legislation and regulation, Air pollution index **04 hrs**

5. Control of Air Pollutants

Control methods -Particulate emission control: gravitational settling chambers, cyclone separators, fabric filters, Electrostatic precipitators, wet scrubbers, etc.

Text Books

1. Rao, H.V.N., and Rao, M.N., *Air Pollution*, Tata McGraw Hill Education Pvt. Ltd., New Delhi, 2007.
2. Rao, C.S., *Environmental Pollution Control*, New Age International Pvt. Ltd, New Delhi, 2006.

Reference Books:

1. A.O.C., Stem, *Air Pollution -Vol I-IV*, Academic Press., 2010.
2. Henry C Perkins, *Air pollution*, Tata McGraw Hill Education Pvt Ltd., New Delhi, 1974.

Open Elective -1

Course Title: Nano Composite Materials

Course Code: 15ECVO401

L-T-P: 3-0-0

Credits: 3

Contact Hours: 3 Hrs/ week

ISA Marks: 50

ESA Marks: 50

Total Marks: 100

Teaching Hours: 40

Examination Duration: 3 Hrs

Unit I

1. Introduction

Introduction to materials, traditional materials, development, properties, strength of and mechanical properties of materials , introduction, definition, classification and characteristics of composite materials - fibrous composites, laminated composites, particulate composites **06 hrs**

2. Fiber and matrices

Carbon fibers, glass fibers, silicon carbide and organic fibers. Polymer matrices, metal matrices and ceramic matrices. **05 hrs**

3. Fabrication and application

Polymer composites, metal composites and ceramic composites Application of composites: Automobile, Aircrafts, missiles, Space hardware, Electrical and electronics, marine, recreational and Sports equipment, future potential of composites. **05 hrs**

Unit II

4. An overview of Nanoscience & Nanotechnology

Historical background – nature, scope and content of the subject – multidisciplinary aspects – industrial, economic and societal implications. **06 hrs**

5. Experimental Techniques and Methods

For investigating and manipulating materials in the nano scale – electron microscope – scanning probe microscope – optical and other microscopes **05 hrs**

6. Introduction to Nanomaterials

Carbon Nanotubes , synthesis and purification – filling of nanotubes – mechanism of growth – electronic structure – transport properties – mechanical and physical properties – applications **05 hrs**

Ventra M., Evoy S., Heflin J.R., *Introduction to Nanoscale Science and Technology* [Series: *Nanostructure Science and Technology*], Springer (2006).

Unit III

Chawla K.K., *Composite Material : Science and Engineering*, 3ed., Springer, 2012.

7. Introduction to nano-composite

Nano composite polymer matrix, nano composite ceramic matrix, nano composite metal matrix Applications in engineering, future scope of nano-composite, research , training in development of nano-composite materials. **05 hrs**

8. Safety and environmental aspects

Safety and environmental aspects of nano-materials, future challenge, cost optimization and fabrication process of nano composite materials **03 hrs**

Text Book:

1. Hull D. and Clyne T.W., *Introduction to Composite Materials*, Cambridge University Press, 2nd edition, 1996.
2. Pradeep T., *NANO: The Essentials – Understanding Nanoscience and Nanotechnology*, 1ed., Tata McGraw-Hill Education Pvt. Ltd, New Delhi, 2017

Reference Books:

1. Ventra M., Evoy S., Heflin J.R., *Introduction to Nanoscale Science and Technology* [Series: *Nanostructure Science and Technology*], Springer (2006).
2. Chawla K.K., *Composite Material : Science and Engineering*, 3ed., Springer, 2012.
3. Linda Williams & Wade Adams *Nanotechnology Demystified*, McGraw-Hill Company Inc, New York, 2007.
4. Johns R.M., *Mechanics of Composite Materials*, 2ed., CRC Press, 2015.

Open Elective -2

Course Title: Optimization Techniques

Course Code: 15ECVO402

L-T-P: 3-0-0

Credits: 3

Contact Hours: 3 Hrs/ week

ISA Marks: 50

ESA Marks: 50

Total Marks: 100

Teaching Hours: 40

Examination Duration: 3 Hrs

UNIT – I

1. Introduction

Engineering applications, optimum design methods, Mathematical statement, Terminology and basic concepts, Classification of optimization problems, Optimization Techniques. **04 hrs**

2. Classical Optimization Techniques

Single variable optimization, Multivariable optimization without constraints, Multivariable optimization with constraints -Lagrange multiplier method and constrained variation method – Kuhntucker conditions. **05 hrs**

3. Linear Programming

Standard form LP, Geometry and solution of LP , Pivotal reduction Simplex method, two phase simplex method, revised simplex method **05 hrs**

ISA Marks: 50

ESA Marks: 50

UNIT – II

4. Non-linear Unconstrained Optimization Search Techniques

One dimensional problems, Elimination Methods - Fibonacci Method, Dichotomous Search, Golden Section Method, Interpolation methods - Quadratic Interpolation Method – Quadratic Interpolation Method, Direct Root Methods, Direct search method- Powell Fletcher method, Hooke and Jeeve's method, Descent methods. **08 hrs**

5. Non-linear Constrained Optimization Search Techniques

Direct Methods - Feasible Direction method, sequential linear programming techniques **08 hrs**
Indirect Method - Interior and Exterior penalty function method.

UNIT – III

6. Geometric Programming

Posynomial, Unconstrained Minimization Problem by Differential Calculus, Constrained Minimization using Geometric Programming. **06 hrs**

7. Dynamic Programming

Multistage decision concert, principles of optimality. **04 hrs**

Text Book:

1. Rao S.S., *Engineering Optimization Theory and Application*, 3ed., New Age International Pvt. Ltd., New Delhi, 2013.

2. Bhavikatti, S.S., *Fundamentals of Optimum Designs in Engineering*, 1ed., New Age Publishers, New Delhi, 2017.
3. Ravindran A, Ragsdel K.M., Reklaitis G.V., *Engineering Optimization: Methods and Applications*, 2ed., Wiley India Pvt. Ltd., 2006.
4. Rudra Pratap, *Getting Started with MATLAB: A Quick Introduction for Scientists & Engineers*, Oxford Uni Press, 2010.

Reference Books:

1. Belegundu A., Chandrupatla T.R., *Optimization Concepts and Applications in Engineering*, 2ed., Cambridge University Press, 2011
2. Bishma Rao GSS, *Optimization Techniques*, Scitech Publication., 2003.
3. Mohan C. and Kusum Deep, *Optimization Techniques*, 1ed., New Age International Pvt. Ltd., New Delhi, 2009.

B.E. (Civil Engineering)
5th & 6th Semester
Curriculum Structure & Syllabus
2019 – 23 Batch
(2019-23 Admission)

Professor & Head
School of Civil Engineering
KLE Technological University
Hubballi.

III Year Bachelor of Engineering (Civil Engineering)

Curriculum Structure – 2017 Scheme

V Semester B.E.

No.	Code	Course	Category	L-T-P	Credits	Contact Hours	ISA Marks	ESA Marks	Total Marks	Exam Duration
1	15ECVC301	Structural Analysis-II	PC	3-0-0	3	3	50	50	100	3 hours
2	15ECVC302	Geotechnical Engineering	PC	3-0-0	3	3	50	50	100	3 hours
3	15ECVC303	Design of RCC Structures	PC	4-0-0	4	4	50	50	100	4 hours
4	15ECVC304	Transportation Engineering	PC	4-0-0	4	4	50	50	100	3 hours
5	15ECVC305	Construction Economics and Management	PC	3-0-0	3	3	50	50	100	3 hours
6	15ECVP301	Highway Engineering Laboratory	PC	0-0-1	1	2	80	20	100	3 hours
7	15ECVP302	Environmental Engineering Laboratory	PC	0-0-1	1	2	80	20	100	3 hours
8	17ECVP301	Design & Construction Workshop	PC	0-0-1	1	2	80	20	100	3 hours
9	15ECVW301	Mini Project	PW	0-0-3	3	3	50	50	100	3 hours
Total				17-0-6	23					

Note: L – Lecture, T – Tutorial, P – Practical, ISA – In Semester Assessment, ESA – End Semester Assessment, PC-Programme Core,

BS – Basic Science, ES- Engineering Science, OE - Open Elective, PE - Program Electives, HS – Humanities, PW – Project

VI Semester B.E.

No.	Code	Course	Category	L-T-P	Credits	Contact Hours	ISA Marks	ESA Marks	Total Marks	Exam Duration
1	15ECVC306	Advanced Geotechnical Engineering	PC	3-0-0	3	3	50	50	100	3 hours
2	15ECVC307	Estimation and Costing	PC	3-0-0	3	3	50	50	100	3 hours
3	15ECVE3**	Program Elective -1	PE	3-0-0	3	3	50	50	100	3 hours
4	15EHSC301	Professional Aptitude & Logical Reasoning	HS	3-0-0	3	3	50	50	100	3 hours
5	15ECVP304	Geotechnical Engineering Laboratory	PC	0-0-1	1	2	80	20	100	3 hours
6	15ECVP305	Computer Aided Design Laboratory	PC	0-0-1	1	2	80	20	100	3 hours
7	15ECVP306	Construction Engineering & Management Laboratory	PC	0-0-1	1	2	80	20	100	3 hours
8	15ECVW302	Minor Project	PW	0-0-6	6	6	50	50	100	3 hours
Total					21					

Note: L – Lecture, T – Tutorial, P – Practical, ISA – In Semester Assessment, ESA – End Semester Assessment, PC-Programme Core,

BS – Basic Science, ES- Engineering Science, OE - Open Elective, PE - Program Electives, HS – Humanities, PW – Project

Program Elective -1:

1	16ECVE301	Pre Stressed Concrete
2	15ECVE302	Traffic Engineering

3	15ECVE303	Pavement Engineering
4	15ECVE304	Engineering Hydrology and Hydraulic Structures

5th Semester

Course Title: Structural Analysis-II

Course Code: 15ECVC301

L-T-P: 3-0-0

Credits: 3

Contact Hours: 3 Hrs/ week

ISA Marks: 50

ESA Marks: 50

Total Marks: 100

Teaching Hours: 40

Examination Duration: 3 Hrs

Unit I

1. Slope Deflection Method

Introduction, Sign convention, Development of slope-deflection equations and Analysis of Beams and Orthogonal Rigid jointed plane frames (sway and non sway) with kinematic redundancy less than/equal to three. (Members to be axially rigid) **08 hrs**

2. Consistency Deformation Method

Introduction, static indeterminacy, Analysis of continuous beam and frame by Consistency Deformation Method. **08 hrs**

Unit II

3. Stiffness Matrix Method

Degree of kinematic indeterminacy of one- and two-dimensional structures, generalized coordinates, Analysis of continuous beams with and without sinking of supports and portal frames kinematic redundancy ≤ 3 . **08 hrs**

4. Flexibility Matrix Method

Development of element flexibility matrices, Development of global flexibility matrix, Analysis of continuous beams, and rigid plane frames to determine for internal forces and displacements. **08 hrs**

Unit III

5. Plastic Analysis

Introduction, plastic hinge and plastic moment capacity, Assumptions, Shape factor for general sections, Collapse load, Basic theorems for finding collapse loads, Methods of plastic analysis, Beam mechanism for continuous beam. **08 hrs**

Text Books

1. Bhavikatti S.S, *Structural Analysis II*, 4ed., Vikas Publishing House India Pvt. Ltd, Bangalore, 2016.
2. Pandit G.S. and Gupta S.P, *Matrix Method of Analysis*, 2ed., McGraw Hill Education India Pvt. Ltd, New Delhi, 2008.
3. Reddy C.S., *Basic Structural Analysis*, 3ed., Tata McGraw Hill Education India Pvt. Ltd New Delhi, 2017.
4. Ram chandra, *Design of steel structures-Vol II*, 12ed, Standard book house, New Delhi 2015

Reference Books:

1. Jain A.K., *Advanced Structural Analysis*, 3ed., Nemchand and Brothers, Roorkee, India, 2015.
2. Leet, Ung, and Anne M., *Fundamentals of Structural Analysis*, 3ed., Tata McGraw Hill Publishing Company, New Delhi, 2017.
3. Norris, C.H. and Wilbur, J., *Elementary Structural Analysis*, 3ed., Tata McGraw Hill Publishing Company, New Delhi, 2005.
4. Bhavikatti S.S, *Matrix Methods of Structural Analysis*, 1ed., I K International Publishing House Pvt. Ltd., 2011.
5. Timoshenko, S.P., and Young, D.H., *Theory of Structures*, McGraw Hill Company, New York, 1965.
6. B. G. Neal, *The Plastic Methods of Structural Analysis*, Chapman and Hall, 1977

Course Title: Geotechnical Engineering

Course Code: 15ECVC302

L-T-P: 3-0-0

Credits: 3

Contact Hours: 3 Hrs/ week

ISA Marks: 50

ESA Marks: 50

Total Marks: 100

Teaching Hours: 40

Examination Duration: 3 Hrs

Unit I

1. Introduction

Introduction to soil mechanics, Phase Diagram, Voids ratio, Porosity, Percentage air voids, Degree of saturation, Moisture content, Specific gravity, Bulk density, Dry density, Saturated density, Submerged density and their inter relationships. **04 hrs**

2. Index Properties of Soils

Index Properties of soils, Activity of Clay, Laboratory methods of determination of index properties of soils. **05 hrs**

3. Classification of Soils

Purpose of soil classification, basis for soil classification, Particle size classification – MIT classification, IS classification, Unified soil classification, Plasticity chart and its importance, Field identification of soils. **03 hrs**

4. Clay Mineralogy and Soil Structure

Types of structure of soil, Valence bonds Soil-Water system, Electrical diffuse double layer, adsorbed water, base-exchange capacity, Isomorphous substitution. Common clay minerals in soil and their structures. **03 hrs**

Unit II

5. Flow of Water through Soils

Darcy's law- assumption and validity, coefficient of permeability and its determination, factors affecting permeability, permeability of stratified soils, Seepage velocity, Superficial velocity and coefficient of percolation, effective stress concept-total stress and effective stress, quick sand phenomena, Capillary Phenomena. Laplace equation-assumptions and limitations only, Characteristics and uses of flow nets, Methods of drawing flow nets for Dams and sheet piles. Estimating quantity of seepage and Exit gradient. Determination of phreatic line in earth dams with and without filter. Piping and protective filter, graded filter. **06 hrs**

6. Compaction of Soils

Definition, Principle of compaction, Standard and Modified proctor's compaction tests, factors affecting compaction, effect of compaction on soil properties, Field compaction control, Proctor needle, Compacting equipments, method of compaction. **04 hrs**

7. Shear Strength of Soils

Concept of shear strength, Mohr's strength theory, Mohr-coulomb theory, conventional and modified failure envelopes, Total and effective shear strength parameters, Concept of pore pressure, factors affecting shear strength of soils, Sensitivity and Thixotropy of clay. Measurement of shear parameters- Direct shear test, unconfined compression test, Triaxial compression test and vane shear test, Test under different drainage conditions.

06 hrs

Unit III

8. Stresses in Soils

Boussinesq's and Westergaard's theories for concentrated, circular, rectangular, line and strip loads. Comparison of Boussinesq's and Westergaard's analysis. Pressure distribution diagrams, contact pressure, Newmark's chart.

04 hrs

7. Shear Strength of Soils

Concept of shear strength, Mohr's strength theory, Mohr-coulomb theory, conventional and modified failure envelopes, Total and effective shear strength parameters, Concept of pore pressure, factors affecting shear strength of soils, Sensitivity and Thixotropy of clay. Measurement of shear parameters- Direct shear test, unconfined compression test, Triaxial compression test and vane shear test, Test under different drainage conditions.

06 hrs

Unit III

8. Stresses in Soils

Boussinesq's and Westergaard's theories for concentrated, circular, rectangular, line and strip loads. Comparison of Boussinesq's and Westergaard's analysis. Pressure distribution diagrams, contact pressure, Newmark's chart.

04 hrs

9. Consolidation of Soils

Definition, Mass-spring analogy, Terzaghi's one dimensional consolidation theory- assumption and limitations. Normally consolidated, under consolidated and over consolidated soils, pre-consolidation pressure and its determination by Casagrande's method. Consolidation characteristics of soil (C_c , a_v , m_v and C_v), Time rate of consolidation. Laboratory one dimensional consolidation test, Determination of consolidation characteristics of soils-compression index, and coefficient of consolidation, determination of coefficient of consolidation by square root of time fitting method, logarithmic time fitting method.

05 hrs

Text Books

1. Alam Singh and Chowdhary G.R, *Soil Engineering in Theory and Practice*, 2ed., CBS Publishers and Distributors Ltd., New Delhi, 2014.
2. Braja M Das, *Principles of Geotechnical Engineering*, 8ed, Cengage Learning India Pvt. Ltd., India, 2014.
3. Punmia B. C., *Soil Mechanics and Foundation Engineering.*, 17ed., Laxmi Publications Co., New Delhi, 2018.

Reference Books:

1. Craig, R.F., *Soil Mechanics*, Spon Press Publishers, New York, 2004.

2. Gopal Ranjan and Rao A.S.R., *Basic and Applied Soil Mechanics*, New Age International Pvt. Ltd., New Delhi, 2016.
3. Murthy V.N.S., *Soil Mechanics and Foundation Engineering*, CBS Publishers & Distributors Pvt. Ltd., New Delhi, 2016.
4. Venkatrahmaiah C., *Geotechnical Engineering*, 6ed., New Age International Pvt. Ltd., New Delhi, 2018.
5. IS - SP-36 (Part – 1) -1987 (R 2006) Compendium of Indian standard on soil engineering – Laboratory Testing of Soils for Civil Engineering Purpose.
6. IS - SP-36 (Part – 2) -1988 (R 2006) Compendium of Indian standard on soil engineering – Field Testing of Soils for Civil Engineering Purpose.
7. Soil Mechanics fundamentals, Muni Budhu, Imperial version, 2010.

Course Title: Design of RCC Structures

Course Code: 15ECVC303

L-T-P: 4-0-0

Credits: 4

Contact Hours: 4 Hrs/ week

ISA Marks: 50

ESA Marks: 50

Total Marks: 100

Teaching Hours: 50

Examination Duration: 4 Hrs

Unit I

1. General Features of Reinforced Concrete

Introduction, Philosophies of design (Brief on Working Stress method). Limit State Method of Design: Design Loads, Materials for Reinforced Concrete, Codal provisions, Concept of Safety: Design Philosophy – Limit State Design principles. Principles of limit states, Factor of Safety, Characteristic design loads, and Characteristic design strength.

05 hrs

2. Ultimate Strength of R.C. Sections

General aspects of Ultimate strength, Stress block parameters for limit state of collapse, Ultimate flexural strength of singly reinforced and doubly reinforced rectangular sections, Ultimate flexural strength of flanged sections, Ultimate shear strength of RC sections, Concept of development length and anchorage.

11 hrs

3. Flexure and Serviceability Limit States

General Specifications for design of beams for flexure -practical requirements, size of beam, cover to reinforcement-spacing of bars. General aspects of serviceability-Deflection limits in IS: 456 – 2000-Calculation of deflection, Cracking in structural concrete members, Calculation of deflections and crack width.

04 hrs

Unit II

4. Design of Flexural members.

General consideration of design of slabs, rectangular slabs spanning one direction, Rectangular slabs spanning in two directions for various boundary conditions. Design of simply supported, cantilever slabs. Design procedures for critical sections for moment and shear. Anchorages of bars, check for development length, Reinforcement requirements, Slenderness limits for beams to ensure lateral stability, Design examples for Simply supported and Cantilever beams for rectangular and flanged sections.

13 hrs

5. Design of Columns

General aspects, effective length of column, loads on columns, slenderness ratio of columns, minimum eccentricity, design of short axially loaded columns, design of column subject to combined axial load, uniaxial and biaxial moment using SP –16 charts

07 hrs

Unit III

6. Design of Isolated footing

Design of isolated Footing subjected to axial load and uniaxial moment. Design of square footing, rectangular footing, rectangular footing with eccentric loads. **07 hrs**

7. Design of Staircase

General features, types of staircase, loads on stairs, effective span as per IS codal provisions, distribution of loading on different types of stairs, Design of stairs. **05 hrs**

Text Books

1. Jain, A.K., *Limit State method of design*, 7ed., Nemichand and Bros., Roorkee, 2012.
2. Punmia B.C., Ashok Kumar Jain, and Arun Kumar Jain *Limit State Design of Reinforced Concrete*, Laxmi Publications Pvt. Ltd., New-Delhi-2016.

Reference Books:

1. Bhavikatti, S. S., *Design of RCC Structural Elements Vol-I*, New Age International Publications, New Delhi, 2016.
2. Krishnaraju, N., *Design of Reinforced Concrete Structures (IS: 456 – 2000)*, 3ed., CBS Publishers, New Delhi, 2016.
3. Robert Park & Thomson, *Reinforced Concrete*, John Wiley & Bros, 2009.
4. S. Unnikrishnan Pillai and Devdas Menon, *Reinforced Concrete Design Third Edition*, Tata McGraw Hill Education Pvt. Ltd., New-Delhi-2017.

IS Codes

1. IS:456-2000, *Plain and Reinforced Concrete – Code of Practice*, (Fourth Revision) BIS, New Delhi, 2007
2. IS:875 (Part 1 & 2) - 1987, *Code of Practice for Design Loads (Other than earthquake) for building and structures*, BIS, 1987
3. SP 16: *Design Aids for Reinforced Concrete to IS 456:1978*.

Course Title: **Transportation Engineering**

Course Code: **15ECVC304**

L-T-P : **4-0-0-0**

Credits: **4**

Contact Hrs: **4**

ISA Marks: **50**

ESA Marks: **50**

Total Marks: **100**

Teaching Hrs: **4**

Exam Duration: **3 Hrs**

Unit – 1

1. Highway Network Planning

Different modes of transportation, Characteristics of road transport, Jayakar committee recommendations and implementation, Types of Roads, Road patterns, planning surveys and Phasing of road development in India, Salient features of 3rd and 4th 20year road development plans, Highway development authorities – NHAI, MoRTH, KSHIP, KRDC, Present scenario of road development nationally and at state level – Bharatmala Project, NGHM, NHDP, PMGSY, Vision 2021, Introduction to highway economics and financing. 3 hrs

2. Highway Alignment

Environmental stewardship in selection of best natural landscape, the terrain or topographical features for road alignment, factors affecting in selection of highway alignment, Engineering surveys, Steps involved in Preparation of Detailed Project Report (DPR) for new highway alignment and realignment of highway. 3 hrs

3. Geometric Design of Highways

Functional design of highways, Cross Section Elements of highways, Sight Distance, Design of Horizontal and Vertical Curves. 14 hrs

Unit – 2

4. Traffic Engineering

Components of road traffic- vehicle, driver and road, Road user, vehicle and traffic characteristics, Methods of traffic study-equipment used, data collection, analysis and interpretation of speed studies, traffic volume count, origin – destination studies, parking studies, accident studies, Traffic flow and roadway capacity – traffic flow characteristics, traffic stream flow characteristics, speed-flow-density relations, concept of PCU, capacity and level of service, Traffic regulations and control - regulations and control on drivers, vehicles and traffic flow, traffic signs, traffic signals, types and design methods, Principles of design of at-grade intersections – channelized, rotary and signal intersections, Introduction to traffic flow theories, Features involved in road safety audit system, Introduction to grade separated intersections. Introduction to public transit system. 14 hrs

5. Pavement Materials

6 hrs

Desirable properties of subgrade soil, road aggregates and bituminous materials relevant to pavement applications. Requirements of pavement quality concrete (PQC), Bituminous mixes- preparation, design and testing. Sustainable management of natural resources in road construction.

Unit – 3

7.Pavement Design and Construction

Embankment / Subgrade, Granular sub base course, Granular base course, Prime Coat, Cementaceous Subbase/Base course, Bituminous base course, Tack Coat, Bituminous surface course, Dry Lean Concrete base course, Pavement Quality Concrete surface course, Compaction and Stabilization techniques in pavement construction, Construction of different types of joints in rigid pavement, Highway drainage system, Integration of science, technology and innovation into highway construction in order to develop a sustainable road project.

10 hrs

Pavement components and their functions -Factors influencing the design of pavements
-Design principles -Design of flexible and rigid pavements as per IRC.

Course Project: Group Traffic Studies - Study on road safety measures, Evaluate existing Parking Facility in KLETU campus, Study on Pedestrian & Cycling facility in the campus Etc.

Text Books (List of books as mentioned in the approved syllabus)

1. Khanna S.K., and C.E.G. Justo, & A. Veeraragavan, Highway Engineering, 10th ed., Nem Chand and Bros. Publishers, Roorkee, 2016.
2. Kadiyali.L.R L.R., Traffic Engineering and Transportation Planning, 10th ed., Khanna Publishers, New Delhi,2017.
3. Kadiyali.L.R. Principles and Practices of Highway Engineering, 7th ed., Khanna Publishers, New Delhi, 2017.
4. Kasthurirangan Gopalkrishnan, Sustainable Highways, Pavements and Materials, Createspace Independent Publication, 2011.
5. Papacostas C.S. and Prevedourous, P.D., Transportation Engineering and Planning, 3 ed., Prentice-Hall India, New Delhi, 2002.

References

1. Fwa, Handbook of Highway Engineering, Taylor & Francis Group, Newyork, 2006.
2. C. Jotin Khisty, B.Kent lal, Transportation Engineering, PHI Learning Pvt. Ltd. New Delhi, 2014.
3. Ministry of Road Transport and Highways (MoRTH), Specification for Road and Bridge Works (5th revision 2014), Indian Road Congress, New Delhi.
4. IRC: 73-1980-Geometric Design Standards for Rural (Non Urban) Highways, Indian Road Congress, New Delhi.

5. IRC: 37-2012 –Guidelines for the Design of Flexible Pavements (Third Revision), Indian Roads Congress, New Delhi.
6. IRC: 58-2015- Guidelines for the Design of Plain jointed Rigid pavements for highway, Indian Roads Congress, New Delhi.
7. IRC SP: 93-2011, Guidelines on requirements for environmental clearance for road projects.
8. IRC SP: 99-2013, Manual of specification and standards for expressways.
9. IRC SP: 19-2001, Manual for survey, investigation and preparation of road projects, Indian Road Congress, New Delhi.
10. IRC SP: 31-1992, New traffic signs', Indian Roads Congress, New Delhi.
11. IRC 9-1994, Traffic census on Non-Urban Roads (First revision), Indian Roads Congress, New Delhi.
12. IRC 64-1990, Guidelines for capacity of roads in rural areas, Indian Roads Congress, New Delhi.
13. IRC 67-2012, Code of practice for road signs, Indian Roads Congress, New Delhi.
14. IRC 70-1977, Regulation and control of mixed traffic in urban areas, Indian Roads Congress, New Delhi.
15. IRC 93 – 1985, Guidelines on design and installation of road traffic signals, Indian Roads Congress, New Delhi.
16. IRC: SP: 44-1996, Highway safety code, Indian Roads Congress, New Delhi.
17. IRC: 102- 1988- Traffic studies for planning bypasses around town, Indian Roads Congress, New Delhi.
18. IRC 124-2017, Bus Rapid Transit (BRT) design guidelines for Indian cities, Indian Roads Congress, New Delhi.
19. IRC: 106- 1990, Guidelines for capacity of urban roads in plain areas, Indian Roads Congress, New Delhi.
20. IRC: 99 – 2018 – Guidelines for traffic calming measures in urban and rural areas, Indian Roads Congress, New Delhi.

Course Title: Construction Economics & Management **Course Code: 21ECVC305**
L-T-P: 3-0-0 **Credits: 3** **Contact Hours: 3 Hrs/ week**
ISA Marks: 50 **ESA Marks: 50** **Total Marks: 100**
Teaching Hours: 40 **Examination Duration: 3 Hrs**

Unit I

1. Project Organization

Introduction, Forms of business organizations, Structure of construction organization, organizing for project management, management levels, traits of a project manager and project coordinator, Factors behind the success of a construction organization. **05 hrs**

2. Construction Economics

Introduction, economic decision making, Time Value of Money, Cash Flow Diagrams, Using Interest Tables, Evaluating Alternatives by Equivalence, Effect of Taxation on Comparison of Alternatives, Effect of Inflation on Cash Flow, Evaluation of Public Projects: Discussion on Benefit-cost Ratio **10 hrs**

Unit II

3. Project Control

Determination of unit costs and total cost of a typical construction project. Project Controls - Introduction, Project life cycle, Overview of project life cycle, earned value management, cost performance Index, Schedule performance index, forecasting methods and problems, resource utilization and cumulative curves, Cost loaded Schedules. **10 hrs**

4. Construction Material Management

Introduction, Material procurement process in construction organization, material management functions, inventory management. **05 hrs**

Unit III

6. Construction Accounts Management

Introduction, Principles of Accounting, Accounting process, Construction Contract Revenue Recognition, Construction contract status report, Limitations of accounting, Balance Sheet, Profit and Loss Account, Working Capital, Ratio Analysis, Funds Flow Statement. **06 hrs**

7. Construction Equipment Management

Introduction, Plant and Equipment Acquisition, Depreciation, Methods of Calculating Depreciation, Example of Depreciation Calculations for Equipment on Site, The Effect of Depreciation and Tax on Selection of Alternatives, Evaluating Replacement Alternatives. **04 hrs**

Text Books

1. Kumar Neeraj Jha, *Construction Project Management – Theory and Practice*, 2ed., Pearson Publication, 2015.

2. Gupta B. L., Amit Gupta, *Construction Management and Machinery*, 5ed, Standard Publications, New Delhi, 2017.

Reference Books:

1. Shrivastava U. K., *Construction Planning and Management*, Galgotia Publication Pvt. Ltd., New Delhi-2007.
2. Verma Mahesh, *Construction planning and Management*, Metropolitan Book Co., Delhi, 1982.
3. Seetharaman S., *Construction Engineering and Management*, Umesh Publications, New Delhi, 2006.

Course Title: Highway Engineering Laboratory

Course Code: 15ECVP301

L-T-P: 0-0-1

Credits: 1

Contact Hours: 2 Hrs/ week

ISA Marks: 80

ESA Marks: 20

Total Marks: 100

Teaching Hours: 30

Examination Duration: 3 Hrs

Unit I

Demonstration Experiment

1. Demonstration of fifth wheel bump integrator, Benkelman beam deflectometer (BBD), Axle load weighing bridge, Specific gravity test on Bitumen

Tests to characterize given aggregates as Highway Construction material

1. Determine the resistance of an aggregate to sudden impact due to moving traffic.
2. Relative measure of the resistance of an aggregate under a gradually applied compressive load through vehicular wheel.
3. Determine the resistance of an aggregate to wearing action caused by vehicular movement.
4. Determine the aggregate quality used in road construction through specific gravity and water absorption test.
5. Aggregate Shape Tests
 - i. Flakiness Index on aggregate
 - ii. Elongation Index on aggregate
 - iii. Angularity Number of aggregate
6. Developing Job mix formula (JMF) for Bituminous Concrete layer by Rothfutch's method of aggregate proportioning and mid gradation method.

Tests to characterize given bitumen sample as Highway Construction material

1. Determine consistency of bitumen sample.
2. Measure the adhesive property of bitumen with aggregates and its ability to stretch by ductility test.
3. Softening temperature of given bitumen sample used in the paving jobs.
4. Classify the given bitumen sample based on viscosity grading method.
5. Determine flash and fire point of bitumen sample.
6. Effect of accelerated heating on given bitumen sample.

Structured Enquiry Test

1. Confirmation of Moorum as a road subgrade material by measuring its required strength through CBR test.
2. Marshall Mix Design and mix property analysis for bituminous concrete adopting mid gradation method.

Open Ended Experiments

1. Conduct Fatigue and rutting performance of Designed Bituminous Concrete mix specimen by using IDT setup and Wheel Tracking Machine.

Reference Books:

1. Khanna S.K., Justo C.E.G., and Veeraragavan, A., *Highway Materials and Pavement Testing*, Nem Chand and Bros, Roorkee

IS Codes

1. IS : (2386:1963)– *Methods of test for aggregates for concrete*
2. IS: 2720 (Part 16)-1997, *Laboratory Determination of CBR*, Rev.2. Indian standard method of test for soils
3. IS 383: 2016 *Indian standard specifications for coarse and fine aggregates from natural sources.*

4. IS 73: 2013, *Indian standard specifications for paving bitumen*'.

Course Title: Environmental Engineering Laboratory **Course Code: 15ECVP302**
L-T-P: 0-0-1 **Credits: 1** **Contact Hours: 2 Hrs/ week**
ISA Marks: 50 **ESA Marks: 50** **Total Marks: 100**
Teaching Hours: 30 **Examination Duration: 3 Hrs**

1. Determination of Solids in Sewage: Total Solids, Suspended Solids, Dissolved Solids, Volatile Solids, Fixed Solids, Settleable Solids.
2. Electrical conductivity and pH.
3. Determination of Calcium, Magnesium and Total Hardness
4. Determination of Alkalinity, Acidity
5. Determination of Sulphates, Chlorides
6. Determination of Dissolved Oxygen and BOD.
7. Determination of COD.
8. Determination of Residual Chlorine.
9. Jar Test for Optimum Dosage of Alum, Turbidity determination
10. Determination of Iron.
11. Determination of Nitrate.
12. Determination of Fluorides.
13. Determination of MPN

Reference Books:

1. *Standard Methods for Examination of Water and Wastewater*, 22nd American Publication – Association, Water Pollution Control Federation, American Water Works Association, Washington DC., 2012

IS Codes

1. IS 10500:2012, *Drinking Water Specification*, BIS, New Delhi
2. IS 3025 (Part 62) : 2006 *Methods of Sampling and Test. (Physical & Chemical) for water and waste water*, BIS, New Delhi
3. IS 3307:1977, *Tolerance Limits For Industrial Effluents Discharged on Land and Irrigation Purpose*, BIS, New Delhi

Course Title: Design & Construction Site Management Workshop.

Course Code: 17ECVP301

L-T-P: 0-0-1

Credits: 1

Contact Hours: 2 Hrs/ week

ISA Marks: 80

ESA Marks: 20

Total Marks: 100

Teaching Hours: 30

Examination Duration: 3 Hrs

Preamble:

Through the courses in the preceding semesters (3rd, 4th and 5th), the students are studying the basics of many courses in the fields of construction engineering and management, structural engineering, geotechnical engineering, environmental engineering and transportation engineering. This course aims to bridge the gaps between theoretical concepts learned in classroom and their practical applications in the industry.

Course will be delivered through a series of site visits and guest lectures from industry experts.

Deliverables:

Student group will be given a hypothetical site where in their job profile will be of a project manager. Guest lectures from project managers and site engineers will provide the necessary tools and work cultures on the site, which the students have to apply to their project.

The students will learn the following concepts as practiced in the field:

1. Roles and responsibilities of various stakeholders involved like the owner, architect, structural consultant and the general contractor.
2. The material procurement process – quality and cost negotiation process. Costs involved in using RMC or procurement of raw materials to produce concrete on site etc.
3. Labour cost negotiations, roles and responsibilities, basic amenities to be provided and person-hour tracking.
4. Safety protocol followed in the jobsite.
5. Process of material delivery on the job site and coordination with the accounts department.
6. Technical problems encountered during execution – For example, deep well located during excavation – design changes to be made, concrete strength failure after 28 days – what measures to be taken, errors during surveying of the building, honeycombing or bulging of concrete etc.
7. Tracking of the progress – both time and cost. Creating of monthly progress reports.
8. Equipment management – renting vs owning, maintenance.
9. Roles and responsibilities on the project manager, site engineers, supervisors,

safety officers.

10. Store management.
11. On site testing and third-party testing – advantages and disadvantages.
12. Site layout for optimum utilization of construction space.
13. Reconciliation of materials like formwork, steel etc.

The student team will submit a comprehensive report about the management of a construction site and the difficulties and solutions employed to their sites and present their case.

References books:

1. Kumar Neeraj Jha, *Construction Project Management: Theory and Practice*, 2ed., Edition, Pearson Publications, 2015.
2. Robert. L Peurifoy and William B. Ledbetter, *Construction planning and Equipment & methods*, Tata McGraw Hill Pvt. Ltd, New Delhi, 3ed., 2010.
3. Ursula Kuehn, *Integrated Cost and Schedule Control in Project Management*, 2ed., 2011.

Course Title: Mini Project

Course Code: 15ECVW301

L-T-P: 0-0-3

Credits: 3

Contact Hours: 3 Hrs/ week

ISA Marks: 50

ESA Marks: 50

Total Marks: 100

Teaching Hours: 40

Examination Duration: 3 Hrs

(To be conducted in the beginning of 5th Semester for a period of 5 days, Viva voce conducted along with 5th semester exams)

An extensive survey training involving investigation and design of the following projects is to be conducted for 6 days. The student shall submit a project report consisting of designs and drawings.

1. General instructions

Reconnaissance survey of the sites and perform fly leveling to establish bench marks.

2. Water Supply and Sanitary Project

Examination of sources of water supply, Calculation of quantity of water required based on existing and projected population. Plotting of village map by using Total station. Location of sites for ground level RL's, overhead tanks underground drainage system surveys for laying the sewers.

3. Highway Project

Preliminary and detailed investigations to align a three alternative routes(min. 1 to 1.5 km stretch) between two given obligatory points. The investigations shall consist of topographic surveying of strip of land for considering alternate routes and for final alignment. Report should justify the selected alignment with details of all geometric designs for traffic and design speed assumed. Drawing shall include key plan initial alignment, final alignment, longitudinal section along final alignment, typical cross sections of road.

NOTE:

A) For the above works Total Station should also be used along with conventional instruments.

B) All relevant drawings to be prepared using AUTOCAD.

Reference Books:

1. Basak N.N., *Text Book of Surveying and levelling*, 2ed., Tata McGraw Hill Education Pvt. Ltd., New Delhi, 2017.
2. Bhavikatti S.S., *Surveying and Leveling Vol-I & II*, I.K. International Publishers, 2016.
3. *CPHEEO: Manual on water supply and treatment*, ministry of urban development, 3ed., 1999.
4. Duggal S.K., *Text Book of Surveying*, 4ed., Tata McGraw-Hill Education Pvt. Ltd, New Delhi, 2013.
5. Garg, S.K., *Water supply Engineering*, 7ed., Khanna Publishers, New Delhi, 2005.
6. Kadiyali, L.R., *Traffic Engineering and Transportation Planning*, 7ed., Khanna

Publishers, New Delhi, 2011.

7. Khanna, S.K., and C.E.G. Justo, & A. Veeraragavan, *Highway Engineering*, 10ed., Nemi Chand and Bros. Publishers, Roorkee, 2015.
8. Modi, P.N., *Sewage Treatment and Disposal Engg.*, 15ed., Std. Book House, New Delhi, 2015.
9. Punmia B.C., Jain, Ashok K. Jain, Arun K. *Surveying Vol. 1 and Vol-2*, Lakshmi Publishers, 2015.
10. *IRC: 37-2012, Guidelines for the Design of Flexible Pavements (Third Revision)*, Indian Roads Congress, New Delhi.
11. *IRC:15-2011, Construction of Concrete Roads*, Indian Roads Congress, New Delhi.
12. *IRC: 58-2015, Guidelines for the Design of Plain jointed Rigid pavements for highway*, Indian Roads Congress, New Delhi.

Course Title: Numerical methods and Statistics
L-T-P: 3-0-0 **Credits: 03**
ISA Marks: 50 **ESA Marks: 50**
Teaching Hours: 04 **Examination Duration: 3hrs**

Course Code: 15EMAB301
Contact Hours: 40
Total Marks: 100

Unit I

1. Numerical Methods **08 hours**

Introduction to numerical methods. Roots of equations using Bisection Method, Newton-Raphson Method, Finite differences, Forward, Backward Operators. Newton Gregory forward and backward interpolation formulae. Newton's divided difference formula for un-equal intervals. Numerical solution of first order ODE, Euler's and Modified Euler's method, Runge Kutta 4th order method. Implementation using C-programming

2. Matrices and System of linear equations **08 hours**

Introduction to system of linear equations; Rank of a matrix by elementary row transformations. Consistency of system of linear equation solution of system by (i) Direct methods-Gauss elimination, Gauss Jordan method (ii) Iterative methods- Gauss-Seidal method. Eigenvalues and Eigenvectors of a matrix. Largest Eigenvalue and the corresponding Eigenvector by power method. Implementation using C-programming.

Unit II

3. Curve fitting and regression **05 hrs**

Introduction to method of least squares, fitting of curves $y = a + bx$, $y = ab^x$, $y = a + bx + cx^2$, correlation and regression..

4. Probability **09 hrs**

Definition of probability, addition rule, conditional probability, multiplication rule, Baye's rule. (no proof) Discrete and continuous random variables- PDF-CDF- Binomial, Poisson and Normal distributions (Problems only).

Unit III

5. Sampling distributions

(a) Sampling, Sampling distribution, Standard error, Null and alternate hypothesis, Type-I and Type- II errors, Level of significance. Confidence limits for means (large sample).

05 hrs

(b) Testing of hypothesis for means. large and small samples and student's t- distribution and Confidence limits for means (small sample).

05 hrs

Text Books

1. Bali and Iyengar, *A text book of Engineering Mathematics*, 6ed, Laxmi Publications(p) Ltd, New Delhi,2003
2. Chapra S C and Canale R P, *Numerical methods for Engineers*, 5ed, TATA McGraw-Hill, 2007
3. Gupta S C and Kapoor V K, *Fundamentals of Mathematical Statistics*, 9ed, Sultan Chand & Sons, New Delhi, 2002

Reference Books:

1. Sastry S S, *Introductory method for numerical analysis*, 3ed, PHI, 2003.
2. J. Susan Milton, Jesse C. Arnold, *Introduction to Probability and Statistics: Principles and Applications for Engineering and the Computing Sciences*, 4th ed, TATA McGraw-Hill Edition 2007.

6th Semester

Course Title: Advanced Geotechnical Engineering

Course Code: 15ECVC306

L-T-P: 3-0-0

Credits: 3

Contact Hours: 3 Hrs/ week

ISA Marks: 50

ESA Marks: 50

Total Marks: 100

Teaching Hours: 40

Examination Duration: 3 Hrs

Unit I

1. Subsurface Exploration

Importance of exploration program, Methods of soil exploration: Boring, sounding tests and geophysical Methods. Types of soil samples. Stabilization of boreholes. Typical bore log. Number and depth of borings for various civil engineering structures. Location of ground water table in fine and coarse grained soils.

03 hrs

2. Lateral Earth Pressure

Active and Passive earth pressures, Earth pressure at rest, Earth pressure coefficients. Earth pressure theories- Rankine's and Coulomb's –assumptions and limitations, Lateral earth pressure in cohesive and cohesionless soils, Earth pressure distribution, Graphical solutions for active earth pressure Cullman's and Rebhann's methods.

06 hrs

3. Stability of Earth Slopes

Types of slopes, causes and type of failure of slopes. Definition of factor of safety, Stability of finite and infinite slopes- Method of slices, Friction Circle method, Felineous method, Taylor's stability number.

06 hrs

Unit II

4. Shallow Foundation

Definitions of ultimate, net and safe bearing capacities, Allowable bearing pressure. Bearing capacity estimation – Analytical and Field methods. Effect of ground water table on bearing capacity.

06 hrs

5. Deep Foundation

Types of Deep foundation - Piles, Drilled Piers and Caissons. Load carrying capacity of pile – Analytical and Field Test. Design of pile and pile groups. Negative skin friction. Introduction to under reamed piles.

06 hrs

6. Foundation Settlement

Settlement Analysis, Data for settlement analysis, computation of settlement, Concept of immediate, consolidation and secondary settlements. Factors affecting settlement. Tolerance BIS specifications for total and differential settlements. Concept of contact pressure and active zone. Settlement of tank foundations.

03 hrs

Unit III

7. Soil Stabilization and Reinforced soil

Introduction. Methods of soil stabilization. Reinforced soil - basic mechanism, choice of soil and reinforcement, Strength characteristics of reinforced soil. Design of Reinforced soil walls. Reinforced soil slab.

06 hrs

8. Containment of solid waste in landfills

Waste containment. Landfills - Shapes and size of landfills, Types of landfills. Impervious barriers for liners and covers. Stability of landfills. Landfill construction and operation. Landfill selection and design aspects.

04 hrs

Text Books

2. Alam Singh and Chowdhary G.R. (1994), *Soil Engineering in Theory and Practice*, 2ed, CBS Publishers and Distributors Ltd., New Delhi, 2014.
3. Braja M. Das, *Principles of Geotechnical Engineering*, 8ed., Cengage Learning India Pvt. Ltd., India, 2014.
4. Punmia B.C., *Soil Mechanics and Foundation Engineering*, 17ed, Laxmi Publications Co., New Delhi, 2018.

Reference Books:

1. Das. B.M, *Principles of Foundation Engineering*, 8ed., Thomson Business Information India (P) Ltd., India, 2014
2. Gopal Ranjan and Rao A.S.R., *Basic and Applied Soil Mechanics*, 3ed, New Age International (P) Ltd., New Delhi, 2016.
3. Knappett J.A and R.F Craig, *Soil Mechanics*, 8ed., Van Nostrand Reinhold Co. Ltd., 2012.
4. Murthy, V.N.S., *Soil Mechanics and Foundation Engineering*, CBS Publishers & Distributors Pvt. Ltd., New Delhi, 2016.
5. Som N.N. and Das S.C, *Theory and practice of foundation engineering*, PHI learning Pvt Ltd, 2009.
6. Sashi K Gulhati and Manoj Datta, *Geotechnical engineering*, Tata Mcgraw Hill Education Pvt. Ltd., New Delhi, 2016.
7. Swami Saran, *Analysis and Design of Substructures: Limit State Design*, 2ed, oxford and IBH Publishing Co. Pvt. Ltd, 2006.
8. Sivakumar Babu G. L., *Introduction to Soil Reinforcement and Geosynthetics*, Universities Press, Hyderabad, 2006.
9. Venkatrahmaiah, C., *Geotechnical Engineering*, 6ed., New Age International (P) Ltd., New Delhi, 2018.
10. Soil Mechanics and Foundations 3rd ed., Muniram Budhu, ISBN: 978-0-470-55684-9, John Wiley & Sons Publishers, 2011.

IS Codes

5. IS 8403 : 1981 (Reaffirmed 2002) *Code of practice for Determination of Bearing Capacity of Shallow Foundations*.
6. IS 2911:1985 Part I to IV (Reaffirmed 1995) *Code of Practice for Design and Construction of Pile Foundations*.
7. IRC-SP-102-2014-*Guidelines for design and construction of reinforced soil*

walls.

8. SP-36 (Part – 2) -1988 (R 2006) *Compendium of Indian standard on soil engineering – Field Testing of Soils for Civil Engineering Purpose*

Course Title: Estimation and Costing

Course Code: 15ECVC307

L-T-P: 3-0-0

Credits: 3

Contact Hours: 3 Hrs/ week

ISA Marks: 50

ESA Marks: 50

Total Marks: 100

Teaching Hours: 40

Examination Duration: 3 Hrs

Unit I

1. Introduction

Different type of estimates, study of various drawing attached with estimates, important terms, units of measurement, Schedule of rates: Substituted items; Recasting of estimate; External services; Prime cost; Day work; Provisional sum; Taking off in Quantity Surveying; Bill of quantities abstract, approximate methods of estimating buildings, cost from materials and labour equations recommended by CBRI –examples.

05 hrs

2. Methods of Estimation

Methods of taking out quantities and cost -center line method, long and short wall method or crossing method.

03 hrs

3. Preparation of Estimates for Building Components

Preparation of detailed and abstract estimates for the following Civil Engineering works -Buildings -Masonry structures and framed structures with flat, sloped RCC roofs. Building components (Beams, Columns and Column Footings, RCC Roof Slabs etc)

08 hrs

Unit II

3. Preparation of Estimates for Truss & Culverts

Wooden and Steel truss, RCC slab culverts, Manhole and Septic tanks,

04 hrs

4. Specifications

Definition of specifications, objective of specifications, standard specifications, essentials of specifications, general and detail specifications of item of works in buildings, specifications of aluminum and wooden partitions, false ceiling, aluminum and fiber doors and windows, various types of claddings.

04 hrs

5. Rate Analysis

Definition and purpose, Types of rate analysis, Working out quantities and rates for the following standard items of works -earth work in different types of soils, cement concrete of different mixes, bricks and stone masonry, flooring, plastering, RCC works, centering and form work for different RCC items, wood and steel work for doors, windows and ventilators.

07 hrs

Unit III

6. Estimation of Roads

Methods for computation of earthwork -cross sections -mid section formula, trapezoidal or average end area or mean sectional area formula, prismoidal formula, for different terrains. Estimation of bituminous road and cement concrete roads.

05 hrs

7. Department (PWD) Procedures / Processes

Types of contract -essentials of contract agreement - legal aspects, penal provisions on breach of contract. Definition of the terms -Tender, E-governance, Standard Bid Document (SBD), E-procurement, KTTP Act, earnest money deposit, security deposit, tender forms, documents and types. Comparative statements, acceptance of contract documents and issue of work orders. Duties and liabilities, termination of contract, completion certificate, quality control, right of contractor, refund of deposit. Administrative approval -Technical sanction. Nominal muster roll, measurement books -procedure for recording and checking measurements - preparation of bills, Arbitration.

04 hrs

Text Books

1. Dutta B.N., *Estimating and Costing in Civil Engineering: Theory and Practice Including Specifications and Valuation*, 28 Rev., ed., CBS Publishers' and Distributors Pvt. Ltd., 2021.
2. Dutta B.N., *Estimating and Costing in Civil Engineering: Theory and Practice Including Specifications and Valuation*, 28Rev., ed., UBS Publishers' Distributors Pvt. Ltd., 2016.

Reference Books:

1. Birde, G.S.; *Text book of Estimating & Costing*, Dhanpath Rai and Sons. New Delhi, 2014.
2. Kohli D.D. and Kohli, R.C., *Text Book of: Estimating and Costing (Civil)*, 12ed., S. Chand Co. New Delhi, 2013.
3. Public Works Department Schedule of Rates 2018-19.
4. Rangawala S.C., *Estimating, Costing and Valuation*, Charotar Publishing House, 17ed., 2017.
5. Karnataka Public Works Department Code 2014

Program Elective -1

Course Title: Pre-Stressed Concrete	Course Code:16ECVE301	
L-T-P: 3-0-0	Credits: 3	Contact Hours: 3 Hrs/ week
ISA Marks: 50	ESA Marks: 50	Total Marks: 100
Teaching Hours: 40	Examination Duration: 3 Hrs	

Unit I

1. Introduction

Definition, Pre tensioning and Post tensioning, Materials for prestressing, Need of High strength concrete and steel, Stress-strain characteristics and properties. Methods of prestressing **3 hrs**

2. Analysis of Sections for Flexure

Basic principles of prestressing: fundamentals, load balancing concept, stress concept and strength concept. Stresses in concrete due to pre-stress and loads, stresses in steel due to loads, Cable profiles, Pressure line and thrust line. **7 hrs**

3. Deflection of Beams

Prediction of short term and Deflections long term deflections of un-cracked members. **5 hrs**

Unit II

4. Design of Beams

Design of pre-tensioned and post-tensioned symmetrical and asymmetrical sections. Permissible stress, design of prestressing force and eccentricity, limiting zone of pre-stressing force cable profile. Analysis of PSC members for shear as per IS 1343-1984. **9 hrs**

5. Analysis of Continuous Beam

Secondary moments in continuous beams, Concordant cable profile for straight and parabolic cable profile. **6 hrs**

Unit III

6. Design of End Blocks

Transmission of pre stress in pre tensioned members, transmission length, Anchorage stress in post- tensioned members. Bearing stress and bearing tensile force-stresses in end blocks-Methods, I.S. Code, provision for the design of end block reinforcement **5hrs**

7. Losses of Prestress

Various losses encountered in pre- tensioning and post tensioning methods, determination of jacking force. **5hrs**

Text Books

1. Krishna Raju, N, *Pre-stressed Concrete*, Tata Mc. Graw Publishers, 2012
2. Rajagopalan N, *Prestressed Concrete*, Narosa book distributors, 2010

Reference Books:

1. Sinha, N .C. & Roy, S.K, *Fundamentals of pre-stressed concrete*, S Chand publications, 2011
2. Lin, T. Y., and Ned H. Burns, *Design of Pre-stressed Concrete Structures*, Wiley India Private limited, 2010
3. Dayarathnam, P Sarah, *Pre-stressed Concrete structures*, Medtech, 2017
4. Ramamrutham, *Pre-stressed Concrete*, Dhanapatrai Publications, 2017

Course Code: 15ECVE304	Course Title: Traffic Engineering	
L-T-P: 3-0-0	Credits: 3	Contact Hrs: 3hrs/week
ISA Marks: 50	ESA Marks: 50	Total Marks: 100
Teaching Hrs: 30		Exam Duration: 3 hrs

Content	Hrs
Unit – 1	
1. Traffic Stream Characteristics Introduction to traffic engineering: Road user characteristics, human and vehicle characteristics; Fundamental parameters and relations of traffic flow: speed, density, volume, travel time, headway, spacing, time-space diagram, time mean speed, space mean speed and their relation, relation between speeds, flow, density, fundamental diagrams	4
2. Microscopic Traffic Characteristics Time headway and Time headway distribution and classification. Random, Constant, Intermediate Headway state. Vehicular speed trajectories, speed characteristics under uninterrupted flow conditions, distance headway characteristics, Vehicle Arrivals, Car-following theories and applications. Traffic stability.	7
3. Macroscopic Traffic Characteristics Temporal, spatial and modal flow patterns, uninterrupted and interrupted traffic flow applications. Speed and travel time variations, travel time and delay study techniques. Density measurement techniques, estimation of total travel time and traffic demand.	4
Unit – 2	
4. Capacity Analysis Capacity and Level of service LOS: Definitions, highway capacity, factors affecting LOS, HCM (Indo-HCM) methods; Urban Street: Classification, operational performance measures, congestion management; Multilane highways: Characteristics, capacity and level of service; Freeway operations: Operational considerations, capacity and level of service of a basic freeway segment, weaving operation; Ramp metering: Merging and diverging areas; gap acceptance, speed at ramps; fixed,	6

reactive, and predictive systems; Corridor analysis: Segment capacity, free flow travel time, queue delay, transit corridor.	
5. Traffic Systems Management Traffic Management- Traffic System Management (TSM) and Travel Demand Management (TDM), Traffic Forecasting techniques, Restrictions on turning movements, One-way Streets, Traffic Segregation, Tidal flow operations, Bus priority techniques. Evaluation of traffic management plan.	4
6. Traffic Stream Models Greenshields's model, Greenberg's logarithmic model, Underwood's exponential model, pipe's generalized model, multi-regime models; Moving observer method. Problems	5
Unit – 3	
7. Shock wave and Queueing Analysis Introduction to shock waves, Shock wave equation, shockwaves at signalized intersections, along a highway, along a pedestrian-way. Deterministic queueing and stochastic analysis.	4
8. Traffic simulation models - Calibration and validation Fundamentals of Traffic Simulation; Concepts of microscopic models. A basic methodological approach for calibrating and validating a microscopic traffic simulation model. Calibration and validation guidelines. Calibration, validation and data availability. Goodness-of-fit measures. Time series analysis comparisons for the validation. Traffic Simulator: MITSIM, VISSIM; Traffic simulation models for mixed traffic conditions.	6

Text Books:

1. Khanna S.K., and C.E.G. Justo, & A. Veeraragavan, Highway Engineering, 10th ed., Nem Chand and Bros. Publishers, Roorkee, 2016.
2. Kadiyali.L.R L.R., Traffic Engineering and Transportation Planning, 10th ed., Khanna Publishers, New Delhi, 2017.
3. May, Adolf D. Traffic Flow Fundamentals. Englewood Cliffs, New Jersey: Prentice-Hall, 1990. ISBN 0139260722.

References:

1. Matson, T.M., Smith W.S., Hurd, H.W. "Traffic Engineering", McGraw Hill Book Co.Inc., New York, 2005.
2. Nicholas J Garber & Hoel, "Traffic and Highway Engineering", 4th ed, 2009.

3. Drew, D.R. "Traffic Flow Theory and Control", McGraw Hill Book CO.2002
4. William R. McShane and Roger P, Roess, "Traffic Engineering", Prentice Hall, New Jersey,2000.
5. Barceló, J. "Models, Traffic Models, Simulation, and Traffic Simulation". Barceló, J. ed. Fundamentals of traffic simulation. New York: Springer, 2010. P. 1.
6. Papacostas, C.A., "Fundamentals of Transportation Engineering." Prentice-Hall of India Private Limited, New Delhi,2000.
7. Whol, Martin Traffic Systems Analysis for Engineers and Planners, McGraw Hill, London.
8. IRC SP: 31-1992, New traffic signs', Indian Roads Congress, New Delhi.
9. IRC 9-1994, Traffic census on Non-Urban Roads (First revision), Indian Roads Congress, New Delhi.
10. IRC 64-1990, Guidelines for capacity of roads in rural areas, Indian Roads Congress, New Delhi.
11. IRC 67-2012, Code of practice for road signs, Indian Roads Congress, New Delhi.
12. IRC 70-1977, Regulation and control of mixed traffic in urban areas, Indian Roads Congress, New Delhi.
13. IRC: 99 – 2018 – Guidelines for traffic calming measures in urban and rural areas, Indian Roads Congress, New Delhi.
14. IRC 93 – 1985, Guidelines on design and installation of road traffic signals, Indian Roads Congress, New Delhi. IRC 124-2017, Bus Rapid Transit (BRT) design guidelines for Indian cities, Indian Roads Congress, New Delhi.
15. IRC: 106- 1990, Guidelines for capacity of urban roads in plain areas, Indian Roads Congress, New Delhi.
16. IRC: SP: 44-1996, Highway safety code, Indian Roads Congress, New Delhi.
17. IRC: 102- 1988- Traffic studies for planning bypasses around town, Indian Roads Congress, New Delhi.

Course Title: Pavement Engineering

Course Code: 15ECVE303

L-T-P: 3-0-0

Credits: 3

Contact Hours: 3 Hrs/ week

ISA Marks: 50

ESA Marks: 50

Total Marks: 100

Teaching Hours: 40

Examination Duration: 3 Hrs

Unit I

1. Fundamentals of Pavement Design

Types of Pavements – Flexible, Rigid & White topping, Desirable characteristics of pavement, requirements of airfield pavements, Functions of individual layer, difference between Highway pavement and Air field pavement.

06 hrs

Factors affecting design and performance of flexible pavement – Design life, Design wheel load, Traffic factors, Climatic factors, subgrade strength and Drainage, ESWL concept and analysis (Stress criteria, deflection criteria and graphical method), EWLF concept and analysis.

2. Stresses and Deflections in Flexible Pavements

Application of elastic theory, stresses, deflections / strains in single, two and three layer system, Applications in pavement design.

08 hrs

Unit II

3. Modern Flexible Pavement Design

Flexible pavement design: Empirical, Semi- empirical and Theoretical design approaches, Principle, Advantages and Application. Detail Design of Flexible pavement as per IRC: 37-2012 Guidelines, comparative study of IRC: 37-2001 and IRC: 37-2012 as differences, Software used for analysis are IITPAVE and KENPAVE.

10 hrs

4. Stresses in Rigid Pavement

Factors considered – Wheel load and its repetition, subgrade strength & proportion, strength of concrete – modulus of elasticity, Analysis of stresses in the rigid pavement, Westergaard's analysis – Modified Westergaard's equations, Critical stresses in the rigid pavement.

05 hrs

5. Design of Rigid Pavement

Design of Rigid pavements as per IRC: 58 -2015.

05 hrs

Unit III

6. Flexible & Rigid Pavement Failures, Maintenance and Evaluation

Types of failures, Causes, Maintenance measures, Functional Evaluation of flexible pavements by Condition survey and roughness study using Bump Integrator, Structural Evaluation of Flexible pavements by BBD, FWD, GPR method. Design of Overlay thickness by BBD method.

06 hrs

Text Books

1. Yoder E.J. and Witczak, *Principles of Pavement Design*, 2ed. John Wiley and Sons, 1975.

2. Khanna, S.K., Justo C.E.G., & A. Veeraragavan, *Highway Engineering*, 10ed. Nem Chand and Bros. Publishers, Roorkee, 2014.
3. Kadiyali L.R. and Dr. Lal N.B., *Principles and Practices of Highway Engineering*, Khanna publishers, 2016.

Reference Books:

1. T. Fwa, *The Handbook of Highway Engineering*, Taylor & Francis Group, Newyork, 2006.
2. Ministry of Road Transport and Highways, *Specification for Road and Bridge Works* (Fifth revision 2014), Indian Road Congress, New Delhi.
3. IRC: 37-2012 -*Guidelines for the Design of Flexible Pavements* (Third Revision), Indian Roads Congress, New Delhi.
4. IRC: 58-2015- *Guidelines for the Design of Plain jointed Rigid pavements for highway*, Indian Roads Congress, New Delhi.
5. IRC 81-1997- *Guidelines for strengthening of flexible road pavements using Benkelman beam deflection technique*, Indian Roads Congress, New Delhi.
6. IRC 101-1988-*Guidelines for Design of Continuously Reinforced Concrete Pavement with Elastic Joints*, Indian Roads Congress, New Delhi.

Course Title: Engineering Hydrology and Hydraulic Structures		Course Code: 15ECVE304
L-T-P: 3-0-0	Credits: 3	Contact Hours: 3 Hrs/ week
ISA Marks: 50	ESA Marks: 50	Total Marks: 100
Teaching Hours: 40	Examination Duration: 3 Hrs	
Unit I		
1. Hydrology and Its Statistics: Flow duration curves, Stage Discharge Curves, Hydrologic Routing, Risk, reliability, and safety factor, Flood frequency studies; Flood forecasting: Rational method, Time Area curves.		07 hrs
Introduction to Water Resources: Basic concepts of systems, need for systems approach in water resources,		02 hrs
2. Reservoir sedimentation: Reservoir Design Studies: Area-volume curves, types of reservoirs and zones of storage, storage capacity of reservoirs, Mass curve technique, Reservoir flood routing, sedimentation of reservoirs. Development of storage-yield-reliability The process of erosion, factors affecting erosion. Trap efficiency and numerical problems. Reservoir sedimentation, life of a reservoir.		07 hrs
Unit II		
1. Gravity Dams and Earthen Dams: Introduction, forces acting on a gravity dam, types of joints. Stress analysis in gravity dam, design of gravity dam, stability analysis and drainage galleries in gravity dams. Introduction, types of Earth dams, Design criteria for Earth dams, causes of failure of earth dams, section of dams, preliminary design criteria and problems on it, control of seepage through earth dams.		10 hrs
2. Cross Drainage works and Spillways: Types of cross drainage works. Features of design of cross drainage works. Design of siphon aqueduct. Introduction, essentials of a spillway, Energy dissipation below spillways.		06 hrs
Unit III		
3. Diversion Head Works: Introduction, Khosla's theory, method of independent variables, elements of design for surface flow. Design of vertical drop weir on Bligh's theory. Function of canal head regulator.		08 hrs
Text Books		
1. Ven Te Chow, Hand Book of Hydrology – M'c Graw Hill Publications, New Delhi, 1987.		
2. Larry W. Mays, Water Resources Engineering - John Wiley & Sons, Inc, Tokyo, 2010		
3. Garg S.K., <i>Irrigation Engineering and Hydraulic Structures</i> , Khanna		

Publications, New Delhi, 2005.

4. Punmia B.C. and Pande Lal, *Irrigation and Water Power Engineering*, 16ed., Laxhmi Publications, New Delhi, 2009.
5. Sharma R.K., *Text Book of Irrigation Engineering and Hydraulic Structures*, S. Chand, New Delhi, 2002.
6. Sathyanarayana Murthy Challa, *Water Resources Engineering*

Reference Books:

1. Modi P.N., *Irrigation, Water Resources, and Water Power Engineering*, Standard Book House, New Delhi, 2004.
2. Madan Mohan Das & Mimi Das Saikia, *Irrigation and Water Power Engineering*, PHI Learning Pvt. Ltd., New Delhi, 2009.
3. Balasubramanya N., *Hydraulic Structures & Irrigation Design Drawing* Tata McGraw Hill Education Pvt. Ltd., New Delhi, 2015.
4. Sathya C, Narayana Murthy, *Design of Minor Irrigation and Canal Structures* Wiley eastern limited, New Delhi, 1990.

Course Title: Geotechnical Engineering Laboratory

Course Code: 15ECVP304

L-T-P: 0-0-1

Credits: 1

Contact Hours: 2 Hrs/ week

ISA Marks: 80

ESA Marks: 20

Total Marks: 100

Teaching Hours: 30

Examination Duration: 3 Hrs

Exercise

1. Tests for determination of specific gravity and moisture content.
2. Grain size analysis of soil sample (sieve analysis).
3. In situ density by core cutter and sand replacement methods.
4. Consistency Limits – Liquid Limit (Casagrande and Cone Penetration Methods), plastic limit and shrinkage limit.
5. Standard Proctor Compaction Test and Modified Proctor Compaction Test.
6. Coefficient of permeability by constant head and variable head methods.
7. Strength Tests
 - a) Unconfined Compression Test.
 - b) Direct Shear Test.
 - c) Triaxial Compression Test (undrained).
8. Consolidation Test- Determination of compression index and coefficient of consolidation.

Demonstration

- a) Demonstration of miscellaneous equipment's such as Augers, Samplers, Rapid Moisture meter, Proctor's needle.
- b) Demonstration of Hydrometer Test.
- c) Demonstration of Free Swell Index and Swell Pressure Test
- d) Demonstration of determination of relative density of sands.
- e) Laboratory vane shear

Open ended experiment

To use soil as foundation material and construction material.

Reference:

1. Braja M. Das., *Soil Mechanics Laboratory Manual*, 8th edition, Oxford University press, 2015.
2. Lambe T.W., *Soil Testing for Engineers*, Wiley Eastern Ltd., New Delhi, 1951.
3. Shamsheer Prakash and P.K.Jain, *Engineering soil testing*, Nem Chand and Bros, Roorkee, 2013.
4. IS - SP-36 (Part – 1) -1987 (R 2006) *Compendium of Indian standard on soil engineering – Laboratory Testing of Soils for Civil Engineering Purpose.*

Course Title: Computer Aided Design Laboratory **Course Code: 15ECVP305**
L-T-P: 0-0-1 **Credits: 1** **Contact Hours: 3 Hrs/ week**
ISA Marks: 80 **ESA Marks: 20** **Total Marks: 100**
Teaching Hours: 30 **Examination Duration: 3 Hrs**

Students should be able to write coding in MS Excel using VBA, compile the same and run, for simple numerical in various civil engineering fields. They should be able to document the laboratory work in the forms of Flow charts, Algorithms, coding, output of results in tabular/graphical formats.

Also they should be able to use the available software (SAP) to analyse a simple structures and present the results in tabular/ graphical formats and generate reports.

Using MS Excel and VBA to solve Civil Engineering Problems

Structural Engineering

1. Calculating and plotting shear force and bending moment diagrams for cantilever, simply supported and fixed beams subjected to a combination of loads.
2. Calculation of deflection diagrams for cantilever and simply supported beams subjected to single point loads and UDL.
3. Design of singly and doubly reinforced rectangular sections subjected to bending moment and shear force by using design sheets developed using VBA.
4. Stability of dams.

Surveying

5. Balancing of closed traverse using transit rule
6. Computation of volume of earthwork in cutting and filling.
7. Setting out a horizontal curve by different methods – (i) Offset from long chord (ii) Perpendicular offset from tangents (iii) Radial offsets from tangents

Transportation Engineering

8. Design of super elevation
9. Design of horizontal and vertical alignment

Geotechnical Engineering

10. Analysis of cantilever retaining wall.
11. Calculation of shear parameters

Fluid Mechanics

12. Most economical section for a canal
13. Water hammer analysis
14. Head over Ogee weir

Use of Structural Analysis Software

The student shall analyse the following structures in SAP:

15. Plane truss subjected to dead loads, live loads and wind loads
16. Continuous beam with at least three spans subjected to dead loads and live loads
17. Plane frame subjected to dead loads, live loads and lateral loads.
18. Analysis of two bay two storey structure under static loading conditions (concrete frame).
19. Analysis of long span steel truss.

Reference Book:

Microsoft Excel 2010 Formulas, John Walkenbach, Wiley-India pvt. Ltd.

Course Title: Construction Engineering & Management Laboratory

Course Code: 15ECVP306

L-T-P: 0-0-1

Credits: 1

Contact Hours: 2 Hrs/ week

ISA Marks: 80

ESA Marks: 20

Total Marks: 100

Teaching Hours: 30

Examination Duration: 3 Hrs

1. Introduction to project management software such as Primavera P6, MS Project, etc.
2. Develop a Work Break-down Structure (WBS) for a residential building of 3 storey.
3. Create and add activities to the WBS and assign relationships as per the logic of the precedence diagram for the residential building. Determine the duration of the project.
4. Apply constraints and filters to the developed activities to develop two-week, one-month and three-month look-ahead schedule.
5. Develop different roles and resources in the resource library and assign to the various activities along with their unit rates.
6. Develop the cost-loaded schedule and create baseline of the project.
7. Perform earned value analysis to track and monitor the project.
8. Building a 3D model of a typical building in AutoCAD Revit 2018 and Synchro (Architectural, Structural and Construction Details)
9. Conduct simulations in Microsoft Visio process simulator to determine most efficient excavation cycles on large scale projects.
10. Conduct Monte-Carlo simulation in Microsoft Excel to perform risk analysis for the project.

Reference Books:

1. Kim Heldman & William Heldman, *Microsoft Excel for Project managers 2007*.
2. P. Harris, *Planning and Scheduling Using Primavera P6 2010*.

Course Title: Minor Project

Course Code: 15ECVW302

L-T-P: 0-0-6

Credits: 6

Contact Hours: 6 Hrs/ week

ISA Marks: 50

ESA Marks: 50

Total Marks: 100

Teaching Hours: 40

Examination Duration: 3 Hrs

Functional and architectural design of a building from, but not restricted to one of the following category: Educational institutions, Administration buildings, Industrial buildings, Commercial buildings, Public facilities such as bus terminus, rail station, hospitals, cinema halls, auditorium etc.

The students shall identify a building for case study and collect data of the building and compare it with HDMC By-laws, NBC-2016 codes and IS codes. Further, students will carry out functional design for their proposed building through bubble diagrams and circulation diagrams and consider aspects such as orientation, aspect, best use of site conditions. The project shall include calculation of loads and analysis and design of components including foundations, columns, beams and slab. Simplified computer aided analysis should be performed.

The student shall submit the following:

- Identification of Project.
- Bubble diagrams and Circulation diagrams
- Logic used to arrive at room dimensions based on ergonomics, furniture sizes and placement, equipment etc.
- Architectural plans, elevations, sections and building services fit for submission to approving authorities
- Preliminary soil investigation.
- Results of structural analysis and design of selected components
- Drawings showing structural details of components designed
- Develop WBS, calculate productivity, create precedence diagram, develop cost-loaded schedule and create a baseline.
- Collection of progress data, update the schedule, perform earned value analysis.

Expected Deliverables:

Identify project details, bubble diagrams and circulation diagrams, complete architectural plans, Soil investigation report, Final structural design drawings and calculations, detailed WBS, productivity calculations, precedence diagram, Initial cost-loaded schedule (Primary Baseline), 1st progress report and earned value report.

Reference:

1. IS 1172 – 1971 Code of Basic Requirements for Water Supply, Drainage and Sanitation (Second Rev.), BIS.
2. IS 1642 – 1960 Code of Practice for Fire Safety in Buildings (General): Materials and Constructions in Buildings, BIS.
3. IS 1648 – 1961 Code of Practice for Fire Safety in Buildings (General): Fire fighting Equipment and its maintenance, BIS.
4. IS 1742 – 1972 Code of Practice for Building Drainage, BIS.
5. IS 2065 – 1972 Code of Practice for Water Supply in Buildings (First Rev.) BIS.
6. IS 3861 – 1975 Method of Measurement of Plinth, Carpet and Rentable Area of Buildings(First Rev.) BIS.
7. IS 4326 – 1993 Earthquake Resistant Design and Construction of Buildings – Code of Practice (Second Rev.)
8. IS 7564 – 1974 Recommendations for Co-ordination of Dimensions in Buildings – Arrangement of Building Components.
9. IS:456-2000, Plain and Reinforced Concrete – Code of Practice, BIS, New Delhi, 2000
10. IS:875 (Part 1) - 1987, Code of Practice for Design Loads (Other than Buildings and Structures – Dead Loads, BIS, 1987
11. IS:875 (Part 2) - 1987, Code of Practice for Design Loads (Other than Buildings and Structures – Live Loads, BIS, 1987.
12. Kraners, Sieverts and Partners. 1977. Open – Plan Offices, UK: McGraw Hill. (English Translation Ritchie, J.L.)
13. Leonard, M. and Cunliffe, R. 1962. Office Buildings, New York: Reinhold
14. National Building Code of India 2016, Bureau of Indian Standards, New Delhi
15. SP:1983 National Building Code of India (First Rev.) BIS.
16. Subramaniyam, T.N. (edited by) n.d. Architects, Engineers and Builders Handbook, Madras: Fairhaven Printers.

B.E. (Civil Engineering)
3rd & 4th Semester
Curriculum Structure & Syllabus
2020 – 24 Batch
(2020-24 Admission)

Professor & Head
School of Civil Engineering
KLE Technological University
Hubballi.

II Year Bachelor of Engineering (Civil Engineering)

Curriculum Structure – 2019 Scheme

III Semester B.E.

S. No.	Code	Course	Category	L-T-P	Credits	Contact Hours	ISA Marks	ESA Marks	Total Marks	Exam Duration
1	20EMAB202	Laplace Transform and Statistics	BS	4-0-0	4	4	50	50	100	3 hours
2	15ECVC201	Building Technology & Services	PC	3-0-0	3	3	50	50	100	3 hours
3	15ECVC202	Surveying	PC	4-0-0	4	4	50	50	100	3 hours
4	15ECVF201	Mechanics of Fluids	ES	4-0-0	4	4	50	50	100	3 hours
5	15ECVF202	Mechanics of Materials	ES	4-0-0	4	4	50	50	100	3 hours
6	16ECVF203	Engineering Geology	ES	2-0-0	2	2	50	50	100	3 hours
7	17ECVP201	Survey Practice I	PC	0-0-1	1	2	80	20	100	3 hours
8	17ECVP202	Building Engineering Drawing	PC	0-0-2	2	4	80	20	100	4 hours
Total										
				21-0-3	24					

Note: L – Lecture, T – Tutorial, P – Practical, ISA – In Semester Assessment, ESA – End Semester Assessment, PC-Programme Core,

BS – Basic Science, ES- Engineering Science, OE - Open Elective, PE - Program Electives, HS – Humanities, PW – Project

IV Semester B.E.

No.	Code	Course	Category	L-T-P	Credits	Contact Hours	ISA Marks	ESA Marks	Total Marks	Exam Duration
1	15EMAB207	Numerical methods and Partial differential equations	BS	4-0-0	4	3	50	50	100	3 hours
2	15ECVC203	Structural Analysis-I	PC	4-0-0	4	3	50	50	100	3 hours
3	15ECVC204	Environmental Engineering	PC	4-0-0	4	3	50	50	100	3 hours
4	15ECVC205	Concrete Technology	PC	3-0-0	3	3	50	50	100	3 hours
5	15ECVC206	Construction Project Management	PC	3-0-0	3	3	50	50	100	3 hours
6	15ECVC207	Hydrology & Irrigation Engineering	PC	3-0-0	3	3	50	50	100	3 hours
7	15ECVP204	Survey Practice - II	PC	0-0-1	1	2	80	20	100	3 hours
8	15ECVP205	Material Testing Laboratory	PC	0-0-2	2	4	80	20	100	3 hours
9	17ECVP203	Engineering Computation Laboratory	PC	0-0-1	1	2	80	20	100	3 hours
Total					25					

Note: L – Lecture, T – Tutorial, P – Practical, ISA – In Semester Assessment, ESA – End Semester Assessment, PC-Programme Core,

BS – Basic Science, ES- Engineering Science, OE - Open Elective, PE - Program Electives, HS – Humanities, PW – Project

Course Title: Building Technology and Services

Course Code: 15ECVC201

L-T-P: 3-0-0

Credits: 3

Contact Hours: 3 Hrs/ week

ISA Marks: 50

ESA Marks: 50

Total Marks: 100

Teaching Hours: 40

Examination Duration: 3 Hrs

Unit I

1. Components of a Building

Introduction, types of building as per NBC, Components of a building – Foundations, RCC components like columns, beams, slabs. Floor structures, roof structures, doors, windows and other openings, building finishes. **05 hrs**

2. Building Materials

Introduction. Properties of concrete and its ingredients, building stones, Clay products, Bricks and tiles; Timber, Plywood, Allied products, Plastics and glass, Paints, Steel, Gypsum and Allied products, Adhesives. Alternate building materials – Sustainability, need, types, applications. **07 hrs**

3. Types of Foundations

Preliminary investigations of soil, Presumptive bearing capacity of soils, Masonry footings, Isolated footings, Grillage footings, Strap footings, Raft foundations, Pile foundations. **05 hrs**

Unit II

4. Stone and Brick Masonry

Rubble masonry, Ashlar masonry, Bonds in brick work (English and Flemish bond). Load bearing and partition walls. Damp proof construction. **03 hrs**

5. Floors and Roofs

Types of flooring (Materials and method of laying), Granolithic, Mosaic, Ceramic, Marble, Polished Granite, Industrial flooring, Flat Roof (R.C.C.), Sloped roof (R.C.C. and Tile roof), Lean to roof, Steel trusses, Water and Weather proof course. **03 hrs**

6. Stairs, Doors and Windows

Types (Classifications) and technical terms in stairs, Requirements of a good stair. Geometric Design of RCC Dog Legged and open well stairs. (Plan and sectional elevation of stairs) Paneled doors, Glazed doors, Flush doors, Collapsible and rolling shutters, Louvered doors, Revolving, sliding and swing doors, Windows, Types, Paneled, Glazed, Bat window, Dormer window, Louvered and corner window, Ventilators. **04 hrs**

7. Building Services

Plumbing Services: Water Distribution, Sanitary – Lines & Fittings; Ventilations: Functional requirements systems of ventilations. Air-conditioning – Essentials and Types; Acoustics – characteristic – absorption – Acoustic design; Fire protection – Fire Hazards – Classification of fire-resistant materials and construction. **04 hrs**

Unit III

8. Plastering and Painting

Purpose of Plastering, Materials of plastering, Lime mortar, Cement Mortar, Methods of plastering, Stucco plastering, Lath plastering, Purpose of Painting, Distemper, Plastic emulsion, Enamel, Powder coated painting to walls and iron and steel surfaces, Polishing of wood surface. **05 hrs**

9. Introduction to cost effective construction and services

Necessity, Advantages, Pre fabrication techniques, Pre cast doors and windows (Pre cast frames and shutters), Alternative Building Materials, Hollow concrete blocks, Stabilized mud blocks, Micro concrete tiles, Precast roofing elements. Water supply and sanitation. Electricity illuminated. Modern services & Air condition, fire detection and protection. **04 hrs**

Text Books

1. Bhavikatti.S.S, *Building Materials*, Vikas Publishing House Pvt Ltd, 2012.
2. Punmia, B.C., Jain A.K., *Building Construction*, 10ed., Lakshmi Publications, New Delhi, 2008.
3. Rai, M. and Jai Sing, *Advanced Building Materials and Construction*, CBRI Publications, Roorkee, 2014.
4. Sushilkumar, *Building Construction*, 20ed., Standard Publisher and Distributors, Delhi, 2014.

Reference:

1. Arora, S.P. and Bindra, S.P., *A Text Book of Building Construction Technology*, Dhanapat Rai Publications (P) Ltd., New Delhi, 2014.
2. Jagadeesh, K.S., Venkatarama Reddy B.V. and Nanjunda Rao K.S., *Alternative Building Materials and Technologies*, New Age International (P) Ltd., New Delhi, 2007.
3. National Building Code of India 2016, Bureau of Indian Standards

Course Title: Surveying

Course Code: 15ECVC202

L-T-P: 4-0-0

Credits: 4

Contact Hours: 4 Hrs / week

ISA Marks: 50

ESA Marks: 50

Total Marks: 100

Teaching Hours: 50

Examination Duration: 3 Hrs

UNIT-I

1. Overview and Measurement of directions

06 hrs

Basic principle of surveying, classification of surveying, Measurement of distance: chain surveying, chain and their types, tapes and their types.

Errors in chain surveying and tape corrections. Introduction of map sheet numbering, coordinate and map projection.

Compass surveying: Difference between prismatic and surveyor's compass, bearings and their types. Calculation of included angles from bearings. Corrections to measured bearings – local attraction. Plotting a traverse, closing error and its adjustment by Bowditch's rule. Traverse computations – Latitude and departure (omitted measurements).

2. Measurement of elevations and contouring

07 hrs

Levelling - Terminologies, Types of levelling instruments viz Dumpy level, Auto level, electronic or digital level and their temporary adjustments, taking observations.

Methods of calculating reduced levels – HI method and rise and fall method.

Types of leveling curvature and refraction correction, sensitiveness of bubble tube.

Contours and contouring, characteristics of contours, contour interval, Contouring methods – Direct and indirect. Interpolation of contours. Preparation of contour maps. Uses of contour maps.

3. Theodolite surveying and Trigonometric levelling

04 hrs

Theodolite surveying, terminologies used in theodolite, ~~parts of a vernier theodolite, temporary adjustments~~. Measurement of horizontal angle, vertical angle and other theodolite applications. Theodolite traversing, locating landscape details.

Basic principles, calculation of heights and distances using single plane method and double plane method

4. Tacheometric Surveying

04 hrs

Basic principle of stadia tacheometry; tacheometric equations for horizontal line of sight, inclined line of sight (LOS), when staff vertical to LOS and when staff normal to LOS; Analectic lens, tangential method of tacheometry, subtense bar, and Beaman's stadia arc; determination of tacheometric constants.

Unit II

5. Curve surveying

06 hrs

Types of curves, circular curve-terminologies, elements of a simple curve, methods of setting out simple curve- linear method, angular method; compound curves- elements of a compound curve, setting out of compound curve; Reverse curve-element of elements of a reverse curve, setting out of reverse curve; Transition curve- requirements of a transition curve, elements of transition curve, setting out of transition curve;

6. Modern Surveying Instruments: Theodolite, EDM and Total Station

08 hrs

Modern theodolites- Micro-optic theodolites, electronic theodolites, digital theodolite Electromagnetic spectrum radar, electromagnetic distance measurement (EDM), EDM equipment- Geodimeter, tellurometer, mekenometer, distomat. Corrections to measurements; Total station-principles and working, temporary adjustments, application- angle measurement, distance measurement (horizontal, vertical and slope)

7. Areas and Volumes

06 hrs

Computation of areas: Area from co-ordinates, latitude and departures, Mid-ordinate method, average ordinate method, Trapezoidal rule, Simpson's rule, Computation of volumes: Volumes from cross sections, Prismoidal formula, and Trapezoidal formula capacity of reservoirs volume of borrow pits, Construction surveying / setting out works: Prerequisites, instruments and methods.

Laying out buildings, Setting-out of culverts, Setting-out bridges – locating the center line – locating bridge piers, Setting-out tunnels – Transferring alignment, transferring bench marks or levels, Setting out Sewer lines

Unit III

8. Introduction to Photogrammetry and Remote Sensing: Terrestrial and Aerial photographs, Photo interpretation, Stereoscopy.

05 hrs

Remote Sensing: Principle, Idealized remote sensing system, Types, applications. Introduction and applications of LIDAR.

9. Modern methods of Surveying

05 hrs

Area from digital planimeter, Satellite based positioning system, Global Positioning System (GPS), basic principles, Satellite configuration, positioning using satellite signals, receivers; Functions - determining position, navigation, tracking, mapping, precise time determination; Application in surveying.

Introduction to GIS (Geographic Information System): Components, software, data, users, features, subsystems, data acquisition, data processing and analysis, communication, management, capabilities, operations, Applications of GIS in civil engineering.

Text Books:

1. Punmia. B.C., Ashok. K. Jain and Arun .K. Jain 'Surveying Voll, Lakshmi Publications, 2014.
2. Bhavikatti S. S, Surveying and levelling, Volume I and II, I. K, International Publishers, New Delhi, 2008.

3. Duggal. S.K, 'Surveying' Volume I and II, Tata McGraw Hill, 2013, New Delhi.
4. W. Schofield 'Engineering Surveying' Fifth Edition, Butterworth-Heinemann, 2001.
5. Lille Sand, John Wiley and Sons, Remote Sensing and Image Interpretation, 7th Edition, 2015.
6. Chandra, A.M., Plane Surveying, 3ed. New Age India Ltd. 2015.

Reference Books:

1. Anderson, J. M. and Mikhail E. M., Introduction to Surveying, TMH, New York, 1985.
2. M. Anjireddy, Remote Sensing and Geographical Information Systems, 4th Edition, BS Publications, 2012.
3. Roy, S.K., Fundamentals of Surveying, Prentice Hall of India, 2010.
4. E-notes: <https://sites.google.com/a/mitr.iitm.ac.in/iitmcivil/ce2080>, 2015.

Course Title: Mechanics of Fluids

Course Code: 15ECVF201

L-T-P: 4-0-0

Credits: 4

Contact Hours: 4 Hrs/ week

ISA Marks: 50

ESA Marks: 50

Total Marks: 100

Teaching Hours: 50 Hrs

Examination Duration: 3 Hrs

Unit I

1. Fluid Properties and Classification of Fluid

Introduction to fluid mechanics, Systems of units, Properties of fluid - Mass density, Specific Volume, Specific Weight, Relative density, Viscosity, Newton's law of viscosity, Compressibility, Vapor pressure, Surface tension, Capillarity. Newtonian and Non-Newtonian Fluids, Ideal and Real fluids. **05 hrs**

2. Fluid Pressure and its Measurement

Definition of pressure with its units and dimensions, pressure at a point. Pascal's law, Hydrostatic pressure law. Different types of pressures, Measurement of pressure, Classification- Simple manometers, Differential manometer and Micro Manometer **05 hrs**

3. Hydrostatics

Definition of total pressure, Center of pressure, Centroid, depth of center of pressure, Hydrostatic force on plane surface submerged horizontally, vertically and inclined. Hydrostatic force on submerged curved surface. Archimedes principle. **05 hrs**

4. Kinematics of Fluids

Description of fluid flow - Lagrangian and Eulerian approaches. Classification of flow; Definition of path line, streamline, streak line, stream tube. Acceleration of flow in one dimensional flow. Continuity equation in differential form. Velocity potential, Stream functions, Stream line, Equipotential line. Relation between velocity potential and stream function. Laplace equation. **05 hrs**

Unit II

5. Dynamics of Fluid Flow

Concept of inertia force and other forces causing motion. Derivation of Euler's equation and Bernoulli's equation with assumption and limitation. Application of Bernoulli's equation on Venturimeter, Orifice meter, Pitot tube. **10 hrs**

Impulse - Momentum equation and its application. Basics of hydraulic machines, specific speed of pumps and turbines

6. Flow through Pipes and open Channels

Introduction; Reynolds number, Definition of hydraulic gradient, energy gradient. Major and minor losses in pipe flow, Equation for head loss due to friction (Darcy's-Weishbach equation).

10 hrs

Uniform flow in open channels, Geometric properties of Rectangular, Triangular, Trapezoidal and Circular channels. Chezy's equation, Manning's equation. Most economical open channels. Specific energy of flowing liquid and critical depth of flow, hydraulic jump, type of flows.

Unit III

7. Dimensional Analysis and Model Studies

Introduction, Systems of units, Dimensions of quantities, Dimensional Homogeneity of an equation. Analysis- Raleigh's method, Buckingham's Π theorem. Non-dimensional numbers: Froude Models, Reynold's models

05 hrs

8. Discharge Measurements

Flow through orifices and its classification, hydraulic coefficients and their relationship, Flow through mouthpieces and its classification. Classification of notches and weirs. Discharge over rectangular, triangular and trapezoidal notches or weirs. Discharge over a broad crested weir, Ogee weir and submerged weir. Current meter and its applications. Estimation of discharge with electronic or sensor devices.

05 hrs

Text Books

1. Arora, K. R., *Fluid Mechanics, Hydraulic and Hydraulics*, Standard Book House, New Delhi, 9th ed 2010.
2. Bansal, R. K., *Fluid Mechanics and Hydraulic Machines*, Revised 9ed. Lakshmi Publications, New Delhi, 2017.
3. Daugherty, R.L., Franzini, J.B., Finnemore, E.J. *Fluid Mechanics with Engineering Applications, 10th edition*, McGraw Hill Publishing Co.Inc, New York, 2001.
4. Modi, P.N. and Seth S.M., *Hydraulics and fluid mechanics*, 2ed., Standard book house, New Delhi, 2010.

Reference Books:

1. Douglas J.F., Gasiorek J.M., and Swaffield J.A., *Fluid Mechanics*, 5ed., Pearson Education, India, 2006.
2. Streeter V.L. and Wylie E. B., *Fluid Mechanics*, McGraw Hill Education, London, 9ed., 2010.

Course Title: Mechanics of Materials

Course Code: 15ECVC202

L-T-P: 4-0-0

Credits: 4

Contact Hours: 4 Hrs/ week

ISA Marks: 50

ESA Marks: 50

Total Marks: 100

Teaching Hours: 50 Hrs

Examination Duration: 3 Hrs

Unit – I

Chapter 1: Introduction to Material Science

Introduction, Properties of Materials, Stress, Strain, Hooke's law, Poisson's Ratio, Stress – Strain Diagram for structural steel and non-ferrous materials, Principles of superposition, Elongation due to self – weight. Total elongation of tapering bars of circular and rectangular cross sections,

06 hrs

Chapter 2: Stress, Strain for Composite Section

Composite section, Volumetric strain, expression for volumetric strain, Elastic constants, relationship among elastic constants, Thermal stresses (including thermal stresses in compound bars).

06 hrs

Chapter 3: Bending Moment and Shear Force in Beams

Introduction, Types of beams loadings and supports, shearing force in beam, bending moment, Sign convention, Relationship between loading, shear force and bending moment, Shear force and bending moment equations, SFD and BMD with salient values for cantilever beams, simply supported beams and overhanging beams considering point loads, UDL, UVL and Couple,

06 hrs

Unit – II

Chapter 4: Bending Stress, Shear Stress in Beams

Introduction – Bending stress in beam, Assumptions in simple bending theory, Pure bending derivation of Bernoulli's equation, Modulus of rupture, section modulus, Flexural rigidity, Expression for horizontal shear stress in beam, Shear stress diagram for rectangular, symmetrical 'I' and 'T' section, Flitched/Composite beam.

06 hrs

Chapter 5: Deflection of Beams

Introduction – Definitions of slope, deflection, Elastic curve derivation of differential equation of flexure, Sign convention, Slope and deflection for standard loading classes using Macaulay's method for prismatic beams and overhanging beams subjected to point loads, UDL and Couple.

06 hrs

Chapter 6: Columns and Struts

Introduction – Short and long columns, Euler's theory on columns, Effective length, slenderness ration, radius of gyration, buckling load, Assumptions, derivations of Euler's Buckling load for different end conditions, Limitations of Euler's theory, Rankine's formula and problems. Analysis and sketching of various stresses in beams (2-D and 3-D).

08 hrs

Unit – III

Chapter 7: Torsion of Circular Shafts

Introduction – Pure torsion-torsion equation of circular shafts, Strength and stiffness, Torsional rigidity and polar modulus, Power transmitted by shaft of solid and hollow circular sections, Stepped and compound bar subjected to torque. **05 hrs**

Chapter 8: Compound Stresses

Introduction, Stress components on inclined planes, General two-dimensional stress system, Principal planes and stresses, Mohr Circle, thin cylinders subjected to pressure, change in length, diameter and volume, thick cylinders - Lamé's equations (excluding compound cylinders). **07 hrs**

Text Books

1. B.S. Basavarajaiah and P. Mahadevappa, "*Strength of Materials in SI units*", 3rd Edition, CBS Publishers, New Delhi, 2011.
2. Bhavikatti, S.S., "*Strength of Materials*", 4th Edition, Vikas Publishers, 2013.
3. Hibbeler R.C., "*Mechanics of Materials*", 9th Edition., Pearson Education Ltd., 2014.
4. Punmia B.C., Jain A.K and Jain A.K, "*Strength of Materials*", 10th Edition., Lakshmi Publications, New Delhi, 2018.

References

1. James M. Gere, "*Mechanics of Materials*", 8th Edition., Thomson Learning, 2014.
2. Bansal R.K, "*A Text book Strength of materials*", 6th Edition, Laxmi Publication, 2017
3. S. Timoshenko "*Strength of Materials: Elementary Theory and Problems - Vol. I*", , 3rd Edition, CBS Publisher, 2004

structures. Seismic source, paleo-seismology, ground motion, site effects, instrumentation in India, seismic hazards in India, Case studies.

Text Books

1. Chenna Kesavulu N., *Textbook of Engineering Geology*, Macmillan India Ltd., 2009.
2. Gokhale K.V.G.K, *Principles of Engineering Geology*, B.S. Publications, Hyderabad 2011.
3. Parbin Singh. A, *Text book of Engineering and General Geology*, Katson publishing house, Ludhiana 2009.
4. Varghese, P.C., *Engineering Geology for Civil Engineering*, Prentice Hall of India Learning Private Limited, New Delhi, 2012.

Reference:

1. Blyth F.G.H. and de Freitas M.H., *Geology for Engineers*, Edward Arnold, London, 2010.
2. Bell F.G.. *Fundamentals of Engineering Geology*, B.S. Publications. Hyderabad 2011.
3. Dobrin M.B, *An introduction to geophysical prospecting*, Tata McGraw Hill Pvt. Ltd, New Delhi, 1988
4. Venkat Reddy. D., *Engineering Geology*, Vikas Publishing House Pvt. Lt, 2010
5. IS: 15662 (2006): *Geological exploration for gravity dams and overflow structures – Code of Practice.*

Course Title: Survey Practice - I

Course Code: 17ECVP201

L-T-P: 0-0-1

Credits: 1

Contact Hours: 2 Hrs / Week

ISA Marks: 80

ESA Marks: 20

Total Marks: 100

Teaching Hours: 30

Examination Duration: 3 Hrs

Demonstrations

1. Study of chain, tape, Ranging rod, Direct Ranging, Dumpy level, Compass and EDM device.
2. Use of planimeter and demonstration of minor instruments like clinometer, hand level, box sextant.
3. To locate contour by direct and indirect method.
4. Introduction to total station

Experiments

1. Plot the boundary layout of a building by using direct ranging and set out the perpendiculars using chain, tape and cross staff.
2. To mark the center line for different types of civil engineering structures (using closed traverse methods) having different shapes.
3. To locate the various positions of objects (trees, electric pole, drainage) along the center line of a road.
4. To setup the temporary bench marks for a given topography using Auto level.
5. To determine difference in elevation between two points using reciprocal leveling and determine the collimation error.
6. To conduct profile leveling for water supply / sewage line / road alignment and to draw the longitudinal section to determine the depth of cut and depth of filling for a given formation level using auto level and total station.

Open Ended Experiments:

- Your company has received a tender on survey work to fix up the plinth level for proposed residential building on a sloping terrain, produce a detailed report for the same.

Reference:

1. Bhavikatti S.S., *Surveying and Levelling Vol-I & II*, 2nd ed., Wiley Publishers, New Delhi, 2019.
2. Punmia, B.C., Ashok.K Jain, Arun.K., *Surveying Vol. I & 2*, 15ed., Laxmi Publishers, New Delhi- 2016.
3. Duggal S. K, '*Surveying*' volume I & II, 4th ed., Tata McGraw Hill, 2017, New Delhi
4. <https://sites.google.com/a/mitr.iitm.ac.in/iitmcivil/ce2080>
5. SP:7, *National Building Code of India*, Bureau of Indian Standards, 2016

Course Title: Building Engineering Drawing

Course Code: 17ECVP202

L-T-P: 0-0-2

Credits: 2

Contact Hours: 4 Hrs/ week

ISA Marks: 80

ESA Marks: 20

Total Marks: 100

Teaching Hours: 40 Hrs

Examination Duration: 4 Hrs

1. Introduction to NBC, Building Bye Laws, Model space and paper space, Bubble diagram, Zoning regulations and Commercial Development Plan (CDP)
2. Bubble diagram with circulation for a residential building
3. Draw plan, front elevation, section, site plan and write schedule of openings, as per Bye Laws, using AutoCAD, for a given site dimensions for different types of buildings and calculate FAR, Plinth area and Carpet area;
 - i. Residential Building
 - ii. Office Building
 - iii. School Building
 - iv. Hospital Building
 - v. College Building
4. Draw water supply, sanitary system and rainwater recharging and harvesting system using By Layer command in AutoCAD for different types of buildings.
5. Draw bubble diagram with circulation using AutoCAD for different types of buildings.

Open Ended Experiment

A client has approached to construct a residential building on a sloping terrain, produce an engineering drawing for the project, collect all/any required data as per the need for the project.

References

1. Bethune, J. D., *Engineering Graphics with AutoCAD*, Pearson Education Publishers, 2017.
2. Chandra, A.M and Chandra, S., *Engineering Graphics with AutoCAD*, 2ed., Pearson Education Publishers, 2004.
3. Gurcharan Singh., *Civil Engineering Drawing*, 7ed., Standard Publishers Distributors, 2014.
4. N. Kumara Swamy, A. Kameswara Rao, *Building Planning and Drawing*, Charator Publishing House Pvt. Ltd., 2007.
5. Shah, M.H and Kale, C.M, *Building Drawing*, Tata Mc Graw Hill Publishing Co. Ltd., 2012.
6. Malik R S and Meo G S, *Civil Engineering Drawing*, 2ed, Asian Publishers/Computech Publications Pvt Ltd, 2010.
7. SP:7, *National Building Code of India*, Bureau of Indian Standards, 2016

Course Title: Engineering Geology Laboratory

Course Code: 15ECVP203

L-T-P: 0-0-1

Credits: 1

Contact Hours: 2 Hrs/ week

ISA Marks: 80

ESA Marks: 20

Total Marks: 100

Teaching Hours: 30 Hrs

Examination Duration: 3 Hrs

1. Describe and identify the minerals based on their physical, special properties, chemical composition and uses.
2. Describe and identify the rocks based on their physical, special properties, and uses.
3. Study of geological maps and their sections: interpreting them in terms of selecting the sites for folded strata.
4. Study of geological maps and their sections: interpreting them in terms of selecting the sites for faulted strata.
5. Study of geological maps and their sections: interpreting them in terms of selecting the sites for various civil engineering structures.
6. Dip and strike (Surface method) problems: Determination of true dip direction and true dip amount for civil engineering structure
7. Dip and strike (Surface method) problems: Determination of Apparent dip direction and apparent dip amount for civil engineering structure
8. Bore hole problems (sub surface dip and strike): three point ground method
9. Bore hole problems (Horizontal ground level) :three point ground method
10. Thickness of strata (out crops) problems: To determine the true thickness, vertical thickness and the width of outcrops on different topographic terrain.

Reference Books:

1. Marutesha Reddy, M.T., *A Text book of Applied Engineering Geology*, New Age International Publishers, 2008.

4th Semester

Course Title: Structural Analysis-I

Course Code: 15ECVC203

L-T-P: 4-0-0

Credits: 3

Contact Hours: 4 Hrs/ week

ISA Marks: 50

ESA Marks: 50

Total Marks: 100

Teaching Hours: 40 Hrs

Examination Duration: 3 Hrs

Unit I

1. Structural Systems

Forms of structures, Conditions of equilibrium, Degree of freedom, Linear and Nonlinear structures, one, two, three dimensional structural systems, Static and Kinematics determinacy of structures. Theorem of minimum potential energy Law of conservation of energy Principle of virtual work.

6
HRS

2. Deflection of Beams

Slope and deflection of simply supported and cantilever beams by Moment area method and Conjugate beam method.

6
HRS

3. Strain Energy

Strain energy and complimentary strain energy, Strain energy due to axial load, bending and shear, Principle of virtual work, Unit load method, The first & second theorem of Castigliano, Betti's law, Clarke - Maxwell's theorem of reciprocal deflection, Problems on beams frames and trusses.

7
HRS

Unit II

4 Analysis of beams and trusses

Analysis of beams (Propped cantilever and trusses) by strain energy and unit load method.

8
HRS

5. Arches and cables

Three hinged circular and parabolic arches with supports at same levels and at different levels. Determination of thrust, shear and bending moment, Analysis of cables under point loads and UDL, length of cables - Supports at same level and at different levels.

6
HRS

6. Consistent deformation method

Analysis of propped cantilever and fixed beams.

6
HRS

Unit III

7. Influence Line Diagrams

Influence line diagrams for simply supported, cantilever and over hanging beams, Influence line diagrams for girders supporting floor beams, Use of Influence line diagrams, Maximum S.F. and B.M. values due to moving loads 6
HRS

8. Two hinged arches:

Parabolic and circular arches 6
HRS

Text Books

1. Bhavikatti S.S, *Structural Analysis I*, 4ed., Vikas Publishing House Pvt. Ltd, Bangalore, 2011
2. Punmia, B. C. Ashok Kumar Jain and Arun Kumar Jain, *Mechanics of Materials*, Laxmi Publications Pvt. Ltd Ltd, New Delhi, 2005.

Reference Books:

1. Reddy C.S., *Basic Structural Analysis*, 3ed., Tata McGraw Hill Education Pvt. Ltd, New Delhi, 2017.
2. A.K. Jain, *Advanced Structural Analysis*, 3ed., Nemchand and Brothers, Roorkee, India, 2015.
3. Leet,, Uang, and Anne M., *Fundamentals of Structural Analysis*, 3ed., Tata McGraw Hill Publishing Company Inc., New York, 2017.
4. Pandit G. S. and Gupta S. P, *Theory of Structures*, Vol I & II, Tata McGraw- Hill Publishing Company, New Delhi, 2017.
5. Ramamruthum, S. and Narayan, R., *Theory of Structures*, Dhanpat Rai Publishing Company, New Delhi, 2017.
6. Prakash Rao D. S., *Structural Analysis, A unified approach*, 1ed., University Press Limited, Hyderabad, 1996.
7. Timoshenko, S. P. and Young, D. H., *Theory of Structures*, Tata McGraw Hill Book Company, New York, 1965.

Course Title: Environmental Engineering

Course Code: 15ECVC204

L-T-P: 4-0-0

Credits: 4

Contact Hours: 4 Hrs/ week

ISA Marks: 50

ESA Marks: 50

Total Marks: 100

Teaching Hours: 50 Hrs

Examination Duration: 3 Hrs

Unit I

1.Introduction

Major causes of global environmental change of key life support systems.
Need for protected water supply.

02 hrs

2. Demand and conveyance of water

Types of water demands, population forecasting- arithmetical, geometrical, incremental increase and simple graphical method. Surface and subsurface sources. Design of the economical diameter of the rising main.

04 hrs

3. Quality of Water

Concept of safe wholesome and palatability of water, Sampling of water, Examination of Water-Physical, chemical and Biological Examinations. Drinking water standards BIS & WHO guidelines. Health significance of Fluoride, Nitrates and heavy metals like Mercury, Cadmium, Arsenic etc.

04hrs

4.Water Treatment

Treatment flow-charts. Aeration- Principles, types of Aerators. Sedimentation aided Coagulant, design, jar test, Theory of filtration, slow sand, rapid sand and pressure filters, design – excluding under drainage system .Theory of disinfection, types of disinfection.

10 hrs

Unit II

5.Miscellaneous Treatment and Distribution of Water

Softening methods of removal of hardness by lime soda process and zeolite process. Adsorption technique, reverse osmosis technique, fluoridation and defluoridation.

05 hrs

System of supply, service reservoirs and their capacity determination, methods of layout of distribution systems.

6. Sewerage systems

Types of sewerage systems. DWF, estimation of storm flow, design of storm water drain. Design of sewers - self cleansing and non-scouring velocities. Design of hydraulic elements for circular sewers flowing full and flowing partially full

06 hrs

7. Sewage characteristics

Physical, Chemical and Biological characteristics, CNS cycle. BOD and COD their significance

03 hrs

8. Disposal of Sewage

Self-purification phenomenon, Zones of purification, Sewage sickness, Sewage farming. Streeter Phelps equation - Oxygen sag curve. **04 hrs**

Unit III

9. Sewage Treatment and sludge disposal

Flow diagram of municipal waste water treatment plant. Preliminary & Primary treatment: Screening, grit chambers, primary sedimentation tanks – Design. **09 hrs**
Theory and design of biological unit operation- Trickling filter and Activated sludge process
Sludge digestion process, Sludge drying beds.
Concepts of Oxidation pond and RBC

Text Books

1. Birdie, G.S., *Water Supply and Sanitary Engineering*, Dhanpath Rai and Son Publishers, New Delhi, 2003
2. Garg, S.K., *Sewage disposal and Air Pollution Engineering*, Khanna Publishers, 2003.
3. Garg, S.K., *Water supply Engineering*, 7ed., Khanna Publishers, New Delhi, 2005.
4. Modi, P.N., *Sewage Treatment and Disposal Engineering*, 15ed., Standard Book House, New Delhi, 2015.
5. Punmia, B. C., and Jain Ashok, *Environmental Engineering-I*, 2ed., Laxmi Publications, New Delhi., 2008.
6. Punmia, B. C., Ashok K Jain and Arun Kumar Jain, *Wastewater Engineering*, Laxmi Publications, New Delhi, 2016.

Reference Books:

1. Metcalf & Eddy, *Wastewater Treatment Engg. & Reuse*, Tata McGraw Hill Publications, 2003.
2. Fair, G.M., Geyer J.C., Okan D.A., *Elements of Water Supply and Wastewater Disposal*, John Wiley and Sons Inc. 2000.
3. Hammer M.J., *Water and Waste Water Technology*, John Wiley and Sons, New York, 2000.
4. Howard S. Peavy, Donald R. Rowe, George Techno Bano Glous, *Environmental Engineering*, McGraw Hill International, 1995.
5. IS:10500-2012, Drinking water- Specification.
6. *Ministry of Urban Development, Manual on Waste Water Treatment - CPHEEO*, New Delhi.
7. Srinivasan, D., *Environmental Engineering*, PHI Learning Pvt. Ltd., New Delhi, 2008.
8. W.K. Berry, *Water Pollution*, CBS Publishers Pvt. Ltd., New Delhi, 2016.

Course Title: Concrete Technology

Course Code: 15ECVC205

L-T-P: 3-0-0

Credits: 3

Contact Hours: 3 Hrs /Week

ISA Marks: 50

ESA Marks: 50

Total Marks: 100

Teaching Hours: 40 Hrs

Examination Duration: 3 Hrs

Unit I

1. Concrete Ingredients

Cement, Chemical composition, hydration of cement, Types of cement, manufacture of OPC by wet and dry process. Tests on cement, Grades of cement, quality of mixing water. Tests on fine and coarse aggregate.

08 hrs

2. Fresh concrete

Workability - factors affecting workability, Measurement of workability, Slump cone test, Compaction factor and vee-bee consistometer test, Segregation and bleeding.

08 hrs

Process of manufacture of concrete, Curing of concrete. Chemical admixtures- Super plasticizers, Accelerators, Retarders, Air entraining agents. Mineral admixtures - Fly ash, GGBS, Silica fume, Rice husk ash.

Unit II

3. Hardened concrete

Factors affecting strength, w/c ratio, gel/space ratio, maturity concept. Effect of aggregate properties, relation between and compressive strength, and tensile strength, bond strength, modulus of rupture. Accelerated curing. Modulus of Elasticity of concrete, Creep, Shrinkage, Factors affecting creep and shrinkage, Extensibility of concrete, Durability - definition, significance, permeability, sulphate attack. Chloride attack, carbonation, freezing and thawing. Factors contributing to cracks in concrete settlement cracks,

10 hrs

4. Concrete Mix design

Concept of Mix design, variables in proportioning exposure conditions, Methods of Concrete Mix design, Procedure of mix design as per IS 10262-2019, Numerical examples of Mix design with river sand and M-sand, Mix Design and testing of SCC, Pavement quality concrete mix design as per IRC guidelines.

06 hrs

Unit-III

5. Special concretes and concreting methods

Constituents, properties and applications of Light weight concrete, High density concrete, High strength and high-performance concrete, Self-Compacting Concrete, EFNARC standards, Fiber reinforced concrete and Ready mixed concrete. Ferro cement - Constituents, properties and applications. Guniting and shotcreting. Pavement Quality concrete, Green concrete for sustainable environment - Geopolymer concrete and concrete wall panel,

05 hrs

6. Non-Destructive testing of concrete

Principles, applications and limitation of Rebound hammer test and Ultrasonic pulse velocity test, interpretation of test values, Rebar test. **03 hrs**

Text Books

1. Bhavikatti S. S., *Concrete technology*, I.K. International Publishing House, 2015.
2. Neville A. M. and Brooks J. J., *Concrete technology, 2ed*, Prentice Hall Publisher, 2010.
3. Shetty M.S., *Concrete technology - Theory and practice*, 1ed., S.Chand and company, New Delhi, 2008.

Reference Books

1. Kumar Mehta P., Paulo J. M. Monteiro - *Concrete: Microstructure, Properties, and Material*, McGraw Hill publications, 2013.
2. Gambhir M. L., "*Concrete Technology*", 3ed., Tata McGraw hill Publishers Pvt. Ltd, New Delhi, 2008.

IS Codes

1. IS-10262-2019, *Recommend guidelines for concrete mix*.
2. IS-383:2016, *Specifications for Concrete mix aggregates from natural resources for concrete (Third revision)*.
3. IS-456:2000, *Code of practice of plain and reinforced concrete*, 4ed., August 2000.
4. IS-516: *Method of Tests for Strength of Concrete*, 2013.
5. IS-13311-2 (1992): *Method of non-destructive testing of concrete-methods of test, Part 2: Rebound hammer*

Course Title: Construction Project Management **Course Code: 21ECVC206**
L-T-P: 3-0-0 **Credits: 3** **Contact Hours: 3Hrs / Week**
ISA Marks: 50 **ESA Marks: 50** **Total Marks: 100**
Teaching Hours: 40 Hrs **Examination Duration: 3 Hrs**

Unit I

1. Introduction to Construction Project Management

Phases of construction project, importance of construction and construction industry, Indian construction Industry, Construction project management and its relevance, stakeholders of a construction project. **04 hrs**

2. Drawings and Specifications

Types of Drawings-Architectural and Structural, Study of Scales Used, sequence of dimensioning, dimension lines and figures, Importance of Specifications, General specifications detailed specifications of a typical building. Scope definition using drawings and specifications. **05 hrs**

3. Work Breakdown Structure

Concept of WBS, Common usage of terms, preparing a WBS, Factors to be considered, WBS measurement considerations, Challenges to be considered, WBS level of Detail, WBS life-cycle considerations, Project risk and the WBS, Resource planning and management with WBS, Problems – Detailed WBS of a residential building. **06 hrs**

Unit II

4. Project Management through Networks

Introduction, project feasibility, planning methods of projects– Objectives, planning stages. Scheduling, Bar charts and mile stone charts. Introduction, Terms & definitions, Elements of network, types of networks, drawing the network. CPM – Event times, Activity times, floats, critical activity and critical path. Problems. PERT – Introduction, time estimates, expected time, earliest expected time, latest allowable occurrence time, slack, critical path. Probability of completing the project. Problems. Updating of network. Problems. Contraction of network. Problems, The Role of the Scheduler in Construction Management, Linear Construction Operations and Line of Balance, Scheduling for Large Programs, Lean Design in Construction Scheduling. **11 hrs**

5. Resource Allocation

Introduction, Objectives of resource allocation, Methods of resource allocation, Resource smoothing, Steps in resource smoothing, Resource levelling, Steps in resource levelling. **04 hrs**

Unit III

6. Sustainability in Construction Industry

Introduction, Objectives of sustainability, recent advances in sustainability in construction industry, green buildings, cost and profitability, sustainability rankings – LEED. **05 hrs**

7. Technology Trends in Construction and BIM

Concept and application of Building Management System (BMS) and Automation. Overview of IT Applications in Construction – Construction process – Computerization in Construction – Computer aided Cost Estimation – Developing application with database software. Introduction – Parametric modeling – Visualisation – Completion of building modeling – 4D simulation using Navis works – Navigation and Clash detection. **05 Hrs**

Text Books

1. Kumar Neeraj Jha, *Construction Project Management: Theory and Practice*, 2ed., Edition, Pearson Publications, 2015.

Reference Books:

1. Robert. L Peurifoy and William B. Ledbetter, *Construction planning and Equipment& methods*, Tata McGraw Hill Pvt. Ltd, New Delhi, 3ed., 2010.
2. Verma Mahesh, *Construction planning and Management*, Metropolitan Book Co. Delhi, 1982.

Course Title: Hydrology & Irrigation Engineering

Course Code: 15ECVC207

L-T-P: 3-0-0

Credits: 3

Contact Hours: 3Hrs / Week

ISA Marks: 50

ESA Marks: 50

Total Marks: 100

Teaching Hours: 40 Hrs

Examination Duration: 3 Hrs

Unit I

1. Introduction to Hydrology

Introduction, Hydrologic cycle, Water budget equation, Precipitation: Forms and type of precipitation, Measurement of precipitation, Selection of rain gauge station. Adequacy of rain gauges, Methods of computing average rainfall, Interpolation of missing rainfall data, Consistency of rainfall data by double mass curve method. Hyetograph and Mass curve of rainfall. Difference between ground water and surface water.

06 hrs

2. Losses from Precipitation

Evaporation: Factors affecting, Measurement by Class A pan, Estimation using empirical methods. Evapo-transpiration: Factors affecting and Measurement, Estimation using Blaney criddle method and Penman–Monteith equation.

05 hrs

Infiltration: Factors affecting and measurement by double ring infiltrometer, Infiltration indices, Horton's equation of infiltration, Runoff and its estimation.

3. Hydrographs: Definition, Components of Hydrograph, Base flow separation, Ground water, Darcy's Law, Types of Aquifer, Unit hydrograph and its derivation, S – curve and its computation.

05 hrs

Unit II

4. Introduction to Irrigation

Definition, Benefits and ill effects of irrigation, Sources of water for irrigation, Systems of irrigation: Surface, Flow irrigation, Lift irrigation, Bandhara irrigation, Micro irrigation, Sprinkler irrigation. Methods of applying water to crops in India.

04 hrs

5. Water Requirements of Crops

Definition of Duty, Delta and Base period, Relationship between Duty, Delta and Base period, Factors affecting duty of water, Soil-water-plant relationship. Crops and crop seasons in India, Irrigation efficiency, Frequency of irrigation, Definition of gross command area, Culturable command area, Culturable cultivated area.

04 hrs

6. Canals: Definition, Types of canals, Alignment of canals and canal regulators. Design of canals by Kennedy's and Lacey's methods.

Cross drainage works: Classifications, Diversion Works: definition, layout. Types of weirs and Barrages. Design of Impermeable floors – Bligh's and Lane's theories.

04 hrs

7. Gravity Dams

Definition, Forces acting on a Gravity dam, Stability Analysis of Gravity Dam,

04 hrs

Elementary and practical profile, Low and high gravity dams, Drainage Galleries.

Unit III

8. Earthen Dams

Introduction, Types of earthen dams, Failure of earthen dams, Drainage arrangements. Phreatic line, determination of phreatic line. **04 hrs**

9. Spillways

Definition, Types of Spillways, Design Principles for an Ogee Spillway. Energy dissipaters, Types of basins. **04 hrs**

Text Books

1. Jayarami Reddy, *Text Book of Hydrology*, 3ed., Laxmi Publications, New Delhi, 2016.
2. Modi P.N., *Irrigation, Water Resources, and Water Power Engineering*, Standard Book House, New Delhi, 2004.
3. Punmia B.C. and Pande L., *Irrigation and Water Power Engineering*, Laxmi Publications, New Delhi, 2000.
4. Raghunath H. M., *Hydrology*, New Age International Pvt. Ltd., Publication, New Delhi, 2006.
5. Subramanya K., *Engineering Hydrology*, 2ed., Tata McGraw Hill, New Delhi, 2005.

Reference Books

1. Garg S.K., *Irrigation Engineering and Hydraulic Structures*, Khanna Publications, New Delhi, 2005.
2. Linsley, Kohler and Paulhus, *Applied Hydrology*, Wiley Eastern Publication, New Delhi, 1988.
3. Michael A.M., *Irrigation Theory and Practices*, Vikas Publications, New Delhi, 2004.
4. Sharma R. K., *Hydrology and Water Resources Engineering*, Oxford and IBH, New Delhi, 2000.

Course Title: Survey Practice - II

Course Code: 15ECVP204

L-T-P: 0-0-1

Credits: 1

Contact Hours: 2 hr / week

ISA Marks: 80

ESA Marks: 20

Total Marks: 100

Teaching Hours: 30

Examination Duration: 3Hrs

List of Experiments

Demonstrations

1. Measurement of horizontal angles with method of repetition and reiteration using theodolite and Total Station, Measurement of vertical angles using theodolite and Total Station.
2. Introduction of GPS.
3. Introduction to GIS, digitization of maps, geo-referencing of topo maps and generating contours.

Experiments

1. To determine the elevation of an object using single plane and double plane method when base is accessible and inaccessible using theodolite and Total station.
2. To set out simple curves using linear methods perpendicular offsets from long chord.
3. To set out simple curves using linear methods by offsets from chords produced.
4. To set out simple curves using Rankine's deflection angles method.
5. To set out compound curve with angular methods.
6. To set out reverse curve between two parallel line with angular methods.

Structured Enquiry

- To set out the center line of columns for different buildings using Total Station.

Open Ended Experiment

- A developer wants to get a landscaping done for a particular area; you as a surveyor are required to develop the layout map of the same area.
- Fix an alignment between two points and produce a detailed report on earthwork.

Reference Books:

1. Bhavikatti S.S., *Surveying and Leveling Vol-I & II*, I.K. International Publishers, 2008.
2. Punmia B.C., Jain, Ashok K. J., and Arun.K. J., *Surveying Vol. 1 & 2*, 15ed., Laxmi Publications (P) ltd, New Delhi, 2005.
3. Duggal S. K., *Surveying Vol-II*, 4e, McGraw Hill Education Pvt. Ltd., New Delhi, 2013.

IS Codes:

1. IS 11134:1984(R2000), *Code of practice for Setting out of Buildings*.
2. SP:7, *National Building Code of India, Bureau of Indian Standards*, 2016
3. IRC: 73-1980-*Geometric Design Standards for Rural (Non Urban) Highways*,

Indian Road Congress, New Delhi.

4. IRC: 86-1983-*Geometric Design Standards for Urban Roads in Plains, India*
Road Congress, New Delhi.

Course Title: Material Testing Lab

Course Code: 15ECVP205

L-T-P: 0-0-2

Credits: 1

Contact Hours: 4 Hrs/ Week

ISA Marks: 80

ESA Marks: 20

Total Marks: 100

Teaching Hours: 40 Hrs

Examination Duration: 3 Hrs

PART A

I. Tests on Cement:

1. Standard consistency of cement
2. Setting time for cement, and Specific surface of cement by Blaine's air permeability apparatus.
3. Specific gravity of cement and Compressive strength of cement.

II. Tests on Fine and Coarse Aggregate:

4. Specific Gravity and water absorption of fine aggregate. Fineness modulus test for fine, Bulking of sand
5. Specific gravity and water absorption of coarse aggregate, Fineness modulus test for coarse aggregate.

III. Tests on Fresh Concrete and Hardened Concrete:

6. Workability of concrete - Slump, Vee-Bee Consistometer and Compaction factor test, with different water cement ratio without plasticizer.
7. Workability of concrete - Slump, Vee-Bee Consistometer and Compaction factor test with different water cement ratio with plasticizer.
8. Compressive Strength, Tensile strength, Flexural strength of concrete.
9. Self-Compacting Concrete.

IV. Prepare the Concrete Mix Design for different grade of concrete for different exposure condition.

V. Demonstration:

Soundness of cement, Durability and Permeability of concrete

VI. Open Ended Experiment:

- To prepare the **concrete** mix design apart from conventional concrete, propose the mix proportions, procure the materials, cast and tests

PART B

Mechanical properties of materials

1. Tension test on Mild steel and HYSD bars.
2. Compression test of Mild Steel, Cast Iron and HYSD Cylinders.
3. Test on Bricks, concrete blocks.
4. Impact tests on Mild Steel. (Charpy & Izode).
5. Flexural Test on wood
6. Shear Test on Mild steel.
7. Hardness tests on ferrous and non-ferrous metals – Brinell's and Rockwell.
8. Torsion test on Mild Steel circular sections.
9. Buckling of struts
10. Unsymmetrical Bending.
11. Non-Destructive Test on Concrete by Rebound hammer, UPV.

Reference:

For Concrete Lab:

1. Bhavikatti S. S., *Concrete technology*, I.K. International Publishing House, 2015.
2. Gambhir M. L., *Concrete Technology*, 3ed. Tata McGraw hill Publishers, New Delhi, 2009.
3. Gambhir M. L., *Concrete Technology*, 3ed., Tata McGraw hill Publishers, New Delhi, 2008.
4. Shetty M.S., *Concrete technology - Theory and practice*, 1ed., S.Chand and company, New Delhi, 2008.

For MT Lab:

1. Bhavikatti S.S., *Strength of materials*, 4ed., Vikas Publishing House, 2018.
2. Gambhir M L and Neha Jamwal, *Building and construction materials- Testing and Quality control* McGraw Education India Pvt. Ltd., 2017
3. Kukreja C B, Kishore K., and Ravi Chawla *Material Testing Laboratory Manual for quality control*, Standard Publishers & Distributors, 2016.
4. Suryanarayana A K, *Testing of Metallic Materials*", Vedams ebooks Pvt. Ltd. New Delhi, 2007.

IS Code:(For Concrete)

1. IS 10262:2019 : Indian Standard Concrete mix proportioning – guidelines
2. IS 456:2000 Code of practice for plain and reinforced concrete
3. IS 383 : 2016 Specification for coarse and fine aggregates
4. IS 4031 (Part 1 to 6) 1996 (Reaffirmed 2005): Method of physical tests for hydraulic cement

5. IS : 2386 (Part 1 to 5) - 1963 (Reaffirmed 2005): Methods of test for aggregates for concrete
6. IS: 516:1959 (Reaffirmed 2004): Methods of testing for strength of concrete
7. IS 455:1989 (Reaffirmed 1995): Specification for portland slag cement
8. IS 1199 :1999 (Reaffirmed 2004): Methods of sampling and analysis of concrete
9. IS 9103 : 1999 (Reaffirmed 2004): Concrete admixtures - specification
10. IS 10510:1983 Specification for vee-bee consistometer
11. IS 5515:1983 Specification for compaction factor apparatus
12. IS 14858:2000 Compression testing machine used for testing of concrete and mortar requirements

IS Codes for steel

1. IS: 1608-2005, *Metallic materials - Tensile testing at ambient temperature*, Third revision
2. IS: 1768-2008, *High strength deformed steel bars and wires for concrete reinforcement-specification*, Fourth revision
3. IS: 1499-1979, *Method for Charpy Impact test (u-notch) for metals*, First revision
4. IS: 1598-19777, *Method for Izode Impact test for metals*, First revision
5. IS: 1500-2005, *Method for Brinell hardness test for metallic materials*, Third Revision
6. IS: 5652 – 1993, (Part -1), *Hard metals - Rockwell test (scale A)*, Second Revision
7. IS: 1917-2012, *Metallic materials - wire - Simple Torsion test*, (Third revision)
8. IS: 1708 -1986, *Methods of testing of small clear specimens of timber*

Course Title: Engineering Computation Laboratory

Course Code: 17ECVP203

L-T-P: 0-0-1

Credits: 1

Contact Hours: 2 Hrs/ week

ISA Marks: 80

ESA Marks: 20

Total Marks: 100

Teaching Hours: 30

Examination Duration: 3 Hrs

Students must be able to write coding in python, compile it and run as applied to the elemental numerical on engineering mathematics and civil engineering subjects like Mechanics of materials, Surveying, transportation, Fluid Mechanics, Structural Dynamics, etc. They should be able to document the lab work in the form of Flow-charts, Algorithms, coding output of results in tabular/graphical formats.

Following is the list of experiments:

1. Introduction to Python programming language: Data types, Operators, Program flow control, User defined functions
2. Working with Arrays, Array operators, Array indexing and slicing, and Plotting graphs
3. Developing and testing a Python function to find the roots of polynomial equations using Newton Gregory forward and backward interpolation.
4. Developing and testing a Python function to solve systems of linear equations using Gauss Elimination method.
5. Developing and testing a Python function to solve linear system of equations using Gauss Seidel iterative method.
6. Developing and testing a Python function to implement Power method for the computation of the largest eigenvalue and corresponding eigenvector.
7. Developing the equations for reactions, shear force and bending moment for a simply supported beam.
8. Developing and testing python function for finding area under the curve by Simpson's method and Trapezoidal method.
9. Developing and testing python function for curve fitting of two polynomial function.
10. Estimating the population for a given year by extrapolation using first, second, third and fourth order interpolating polynomials and comparing the prediction with actual results.

Open ended:

- Developing and testing python function related to Civil Engineering problem

Text Book

1. Mark Lutz, *Programming python*, O'Reilly Media, 2010.
2. Alex Martelli, *Python in a nutshell*, O'Reilly Media, 2003.
3. M.K.Jain, S.R.K.Iyengar, R.K.Jain, *Numerical Methods for scientific and engineering computation*, New Age International Publishers, 2003.

KLE Technological University, Hubballi

 KLE Technological University Creating Value Leveraging Knowledge Earlier known as B. V. B. College of Engineering & Technology	FORM ISO 9001: 2008 – BVBCET School of Electronics	Document #: FMCD2005	Rev: 1.0

**Batch 2021-25
Course Content**

Course Code: 18EECF101	Course Title: Basic Electronics (Electrical Stream)	
L-T-P-Self Study: 4-0-0-0	Credits: 4	Contact Hrs: 50
ISA Marks: 50	ESA Marks: 50	Total Marks: 100
Teaching Hrs: 50		Exam Duration: 3 hrs

Content	Hrs
Unit – 1	
Chapter 1: Trends in Electronic Industries Introduction, Roadmap of electronic sector, scope and opportunities in various segments of electronics (i.e. Consumer, Telecom, IT, Defense, Industrial, Medical and Automobiles), Government and private sectors, Growth profile of Electronic industries, Standards and Policies, Electronic System Components.	03 hrs
Chapter 2: Basic components, devices and Applications Diode: PN junction characteristics; modeling as a circuit element, ideal and practical diode. AC to DC converter: Half wave and full wave rectifier (centre tap and bridge), capacitor filter and its analysis, numerical examples. Zener diode and its applications (Voltage reference and voltage regulator). Realization of simple logic gates like AND and OR gates.	08 hrs
Chapter 3: Transistor BJT, transistor voltages and currents, Signal amplifier (Fixed bias, Collector base bias, Voltage divider bias, CE configuration). DC load line. Voltage, current and power gains. Transistor as a switch: NOT Gate, Basic (DTL) NAND gate.	09 hrs
Unit – 2	
Chapter 4: Digital Logic Number systems: Decimal, Binary, Octal and Hexadecimal number systems, Conversions, Binary Operations-Addition and subtraction in binary number systems. Logic gates: Realization of simple logic functions using basic gates (AND, OR, NOT), Realization using universal gates (NAND, NOR). Boolean algebra: Theorems and postulates, DeMorgan's Theorems, simplification of logical expressions, Karnaugh Maps, Use of Karnaugh Maps to Minimize Boolean Expressions(2 Variables, 3 Variables and 4 Variables), Design of HalfAdder and Full Adder, Parallel Adder using full adders..	13 hrs
Chapter 5: Operational Amplifier OPAMP characteristics (ideal and practical). Concept of positive and negative feedback (At zero frequency). Linear and non-linear applications: Inverting amplifier, Non inverting amplifier, Voltage follower, Integration, Differentiation, Adder, Subtractor, ZCD and Comparator.	06 hrs
Unit – 3	

 KLE Technological University Creating Value Leveraging Knowledge Earlier known as B. V. B. College of Engineering & Technology	FORM ISO 9001: 2008 – BVBCET School of Electronics	Document #: FMCD2005	Rev: 1.0
Title: Curriculum structure semester wise Electronics and Communication Engineering			Page 2 of 92 Year:

Chapter 6: Communication Systems Basic block diagram of communication system, types of modulation. Amplitude modulation: Time-Domain description, Frequency-Domain description. Generation of AM wave: square law modulator. Detection of AM waves: envelope detector. Double side band suppressed carrier modulation (DSBSC), Generation of DSBSC wave: balanced modulator, Super heterodyne principle.	07 hrs
Chapter 7: Linear Power Supply, UPS & CRO Working principle of linear power supply, UPS and CRO. Measurement of amplitude, frequency and phase of a given signal.	04 hrs

Text Books (List of books as mentioned in the approved syllabus)

- 1) David A Bell, Electronic devices and Circuits, PHI New Delhi, 2004.
- 2) K.A Krishnamurthy and M.R.Raghuveer, Electrical, Electronics and Computer Engineering for Scientist and Engineers, 2, New Age International Publishers, 2001
- 3) A.P. Malvino, Electronic Principles, 6, Tata McGraw Hill, 1999

References

- 1) George Kennedy, Electronic Communication Systems, 4, Tata McGraw Hill, 2000
- 2) Morris Mano, Digital logic and Computer design, 21st Indian print Prentice Hall India, 2000
- 3) Floyd, Digital fundamentals, 3, Prentice Hall India, 2001
- 4) Ramakant Gaikwad, Operational Amplifiers & applications, 3, PHI, 2000

 KLE Technological University Creating Value Leveraging Knowledge Earlier known as B. V. B. College of Engineering & Technology	FORM ISO 9001: 2008 – BVBCET School of Electronics	Document #: FMCD2005	Rev: 1.0

Course Code: 21EEXF101	Course Title: Basic Electrical and Electronics Engineering (Mechanical Science)	
L-T-P-Self Study: 4-0-0-0	Credits: 4	Contact Hrs: 47
ISA Marks: 50	ESA Marks: 50	Total Marks: 100
Teaching Hrs: 47		Exam Duration: 3 hrs

Content	Hrs
Unit – 1	
Chapter 1: Introduction to Electrical & Electronics Technology Electrical Power Generation (convention and renewable energy sources, with PV elaborated), transmission, distribution, utilization (Electric Vehicle as a case study), Electrical and Electronic Systems, concept and power of abstraction, lumped circuit abstraction, and its limitation.	02 hrs
Chapter 2: The Circuit Abstraction Energy storage and dissipating elements (RLC), Ideal and practical sources, series and parallel circuits, concept of order of the system, voltage dividers, RC, RL, RLC with KCL and KVL, Mesh and Nodal analysis with an example.	10 hrs
Chapter 3: Introduction to Transformer and Electric Drive Electromagnetic principles, classification of electric machines – static and rotary, transformers, motors, PMDC, stepper, BLDC, single and three-phase induction motors, selection of motors for various applications. Safety measures.	10 hrs
Unit – 2	
Chapter No. 4: Semiconductor Devices and its Applications Fundamentals of semiconductors, PN junction diode, BJT, FET, Thyristors, Integrated circuits, Linear application – Transistors and Operational amplifiers, oscillators (Op-Amp based), Nonlinear application – Power electronics converters.	10 hrs
Chapter No. 5: Digital Abstraction Concept of digital abstraction, Number systems, base conversion – binary, decimal, hexadecimal, BCD, Gray code, Boolean algebra, logic gates, combinational circuits, - half adders, full adders, half subtractor and full subtractor using k-maps for 2 or 3 variables, sequential circuits – registers, counters.	10 hrs
Chapter No. 6: Mechatronic Subsystem Power supply, Introduction to sensors and actuators, signal conditioning and interfacing, Control logic design for mechatronic applications.	5

 KLE Technological University Creating Value Leveraging Knowledge Earlier known as B. V. B. College of Engineering & Technology	FORM ISO 9001: 2008 – BVBCET School of Electronics	Document #: FMCD2005	Rev: 1.0
Title: Curriculum structure semester wise Electronics and Communication Engineering			Page 4 of 92 Year:

Text Books (List of books as mentioned in the approved syllabus)

1. Anant Agarwal and Jefferey H. Lang, Foundations of Analog and Digital Electronic Circuits, Morgan Kaufmann -Elsevier, 2005
2. Hughes, Electrical and Electronic Technology, 12th Edition, Pearson, 2016.

References

1. N.P.Mahalik, Mechatronics - Principles, Concepts and Applications, Tata McGraw-Hill, 2011
2. K.A Krishnamurthy and M.R.Raghuveer, Electrical, Electronics and Computer Engineering for Scientist and Engineers, 2, New Age International Publishers, Wiley Eastern, 2001
3. George Kennedy, Electronic Communication Systems, 4, Tata McGraw Hill, 2000
4. Morris Mano, Digital Logic and Computer Design, 21st Indian print Prentice Hall India, 2000
5. Boylestead Nashelsky, Electronic devices & Circuit theory, 6, Prentice Hall India, 2000
6. David A Bell, Electronic Devices and Circuits, PHI New Delhi, 2004
7. Ramakant Gayakwad, Operational Amplifiers & applications, 3, PHI, 2000
8. W.Bolton, Mechatronics - Electronic Control Systems in Mechanical and Electrical Engineering, 3, Pearson Education, 2005
9. Ernest O Doebelin, Dhanesh N Manik, Measurement Systems, 6th Edition, McGraw Hill Education; 2017

 KLE Technological University Creating Value Leveraging Knowledge Earlier known as B. V. B. College of Engineering & Technology	FORM ISO 9001: 2008 – BVBCET School of Electronics	Document #: FMCD2005	Rev: 1.0
			Title: Curriculum structure semester wise Electronics and Communication Engineering

**Batch 2020-24
Semester: III**

No	Code	Course	L-T-P	Credits	Contact Hours	ISA	ESA	Total	Exam Duration
1	15EMAB203	BS: Integral Transforms and Statistics	4-0-0	4	4	50	50	100	3 hours
2	15EECC201	PC1: Circuit Analysis	4-0-0	4	4	50	50	100	3 hours
3	15EECC202	PC2: Analog Electronic Circuits	4-0-0	4	4	50	50	100	3 hours
4	19EECC201	PC3: Digital Circuits	4-0-0	4	4	50	50	100	3 hours
5	19EECC202	PC4: Signals & Systems	4-0-0	4	4	50	50	100	2 hours
6	15EECP201	PCL1: Digital Circuits Lab	0-0-1	1	2	80	20	100	2 hours
7	15EECP202	PCL2: Analog Electronic Circuits Lab	0-0-1	1	2	80	20	100	2 hours
8	21EECF202	ES2: Microcontroller Architecture & Programming C Programming (Dip)	0-0-3	3	6	80	20	100	2 hours
	18EECF204		0-0-2	2	4				
TOTAL			20-0-5	25	32	490	310	800	

**Note : Regular 25 Credit
Diploma : 24 Credits**

ISA: In Semester Assessment **ESA:** End Semester Assessment **L:** Lecture **T:** Tutorials **P:** Practical
HS (Humanities) = H; **B**(Basic Science) = B; **ES**(Engineering Science) = F; **PC** (Program Core) = C;
EC(Any Elective) = E; **PW**(Project Work) = W; **Research** = R; **Internship**= I; **Seminar** = S; **Colloquium**
 = V; **Self-study** = Y; **Special topic**= T; **Apprenticeship** = A; **Laboratory / Practical** = **Field Work** = D; and
Non-credit course = N.

 KLE Technological University Creating Value Leveraging Knowledge Earlier known as B. V. B. College of Engineering & Technology	FORM ISO 9001: 2008 – BVBCET School of Electronics	Document #: FMCD2005	Rev: 1.0
			Title: Curriculum structure semester wise Electronics and Communication Engineering

Semester: IV

No	Code	Course	L-T-P	Credits	Contact Hours	ISA	ESA	Total	Exam Duration
1.	17EMAB208	BS: Linear Algebra & Partial Differential Equations	4-0-0	4	4	50	50	100	3 hours
2.	21EECC209	ES4: Electromagnetic Fields and Waves	3-0-0	3	3	50	50	100	3 hours
3.	19EECC203	PC5: Linear Integrated Circuits	4-0-0	4	4	50	50	100	3 hours
4.	15EECC206	PC6: Control Systems	4-0-0	4	4	50	50	100	3 hours
5.	15EECC207	PC7: ARM Processor & Applications	3-0-0	3	3	50	50	100	3 hours
6.	15EECC208	PC8: Digital System Design using Verilog	0-0-2	2	4	80	20	100	2 hours
7.	15EECP203	PCL3: Data acquisition and controls Lab	0-0-1	1	2	80	20	100	2 hours
8.	15EECP204	PCL4: ARM Microcontroller Lab	0-0-1	1	2	80	20	100	2 hours
9.	21EECF201 21EECF203	PCL3: Data Structure Applications Lab PCL3: Data Structure Using C Lab(Diploma)	0-0-2 0-0-3	2 3	4 6	80	20	100	2 hours
TOTAL			18-0-6	24	30	570	330	900	

Note : Regular 24 Credit
Diploma : 25 Credits

 KLE Technological University Creating Value Leveraging Knowledge Earlier known as B. V. B. College of Engineering & Technology	FORM ISO 9001: 2008 – BVBCET School of Electronics	Document #: FMCD2005	Rev: 1.0
			Title: Curriculum structure semester wise Electronics and Communication Engineering

Program: III Semester Bachelor of Engineering (Electronics & Communication Engineering)			Teaching Hours
Course Title: Integral transforms and Statistics		Course Code: 15EMAB203	
L-T-P: 4-0-0	Credits: 04	Contact Hours: 4Hrs/week	
ISA Marks: 50	ESA Marks: 50	Total Marks: 100	
Teaching Hours: 50Hrs	Examination Duration: 3 Hrs		
Unit I			
Chapter 1. Laplace Transforms Definition, transforms of elementary functions- transforms of derivatives and integrals- Properties. Periodic functions, Unit step functions and Unit impulse functions. Inverse Transforms- properties- Convolution Theorem. Initial and Final value theorems, examples; Applications to differential equations, Circuit equations			10
Chapter 2: Probability Definition of probability, conditional probability, Baye's rule, Chebyshev's inequality, random variables- PDF-CDF- Probability Distributions: Binomial, Poisson, Exponential, Uniform, and Normal			10
Unit II			
Chapter 3: Regression : Introduction to method of least squares, fitting of curves $y=a+bx$, $y = ab^x$, correlation and regression. Engineering problems.			05
Chapter 4: Fourier Series Complex Sinusoids, Fourier series representations of four classes of signals, Periodic Signals: Fourier Series representations, Derivation of Complex Co-efficients of Exponential Fourier Series and Examples. Convergence of Fourier Series. Amplitude and phase spectra of a periodic signal. Properties of Fourier Series(with proof): Linearity, Symmetry Properties, Time shift, Frequency Shift, Scaling, Time differential differentiation coefficients, Time domain Convolution, Multiplication Theorem, Parseval's theorem and Examples on these properties.			08
Chapter 6: Fourier Transform : Fourier representation of non-periodic signals, Magnitude and phase spectra. Properties of Fourier Transform: Linearity, Symmetry Properties, Time shift, Frequency Shift, Scaling, Time differential differentiation coefficients, Time domain Convolution, Multiplication Theorem, Parseval's theorem and Examples on these properties.			07
Unit III			
Chapter 6: Random Process: 1. Introduction to Joint Probability Distributions, marginal distribution, joint pdf and cdf, mean, variance, covariance, correlation. 2. Introduction to Random process, stationary process, mean, correlation and covariance function, autocorrelation function, cross correlation, Power spectral Density: properties of the spectral density; Gaussian Process: Properties of Gaussian process.			10

 KLE Technological University Creating Value Leveraging Knowledge Earlier known as B. V. B. College of Engineering & Technology	FORM ISO 9001: 2008 – BVBCET School of Electronics	Document #: FMCD2005	Rev: 1.0
			Title: Curriculum structure semester wise Electronics and Communication Engineering

<p>Text Books</p> <ol style="list-style-type: none"> 1. Kreyszig E., Advanced Engineering Mathematics , , 10th edition, Wiley, 2015 2. Gupta S C and Kapoor V K, Fundamentals of Mathematical Statistics, 11th edition, Sultan Chand & Sons, 2018 3. Walpole and Myers, Probability and Statistics for Engineers and Scientists, ; 9th edition , Pearson Education India, 2013. <p>References</p> <ol style="list-style-type: none"> 1. Simon Haykin, Barry Van Veen, Signals and Systems Wiley; Second edition ,2007 2. J. Susan Milton, Jesse C. Arnold, Introduction to Probability and Statistics: Principles and Applications for Engineering and the Computing Sciences, 4th edition, TATA McGraw-Hill Edition, 2017 	
--	--

Program: III Semester Bachelor of Engineering (Electronics & Communication Engineering)		Teaching Hours
Course Title: Circuit Analysis		Course Code: 15EECC201
L-T-P-SS: 4-0-0	Credits: 4	Contact Hours: 4Hrs/week
ISA: Marks: 50	ESA: Marks: 50	Total Marks: 100
Teaching Hours: 50Hrs	Examination Duration: 3 Hrs	
Unit I		
Chapter 1: Basics Active and passive circuit elements, Voltage & current sources, Resistive networks, Nodal Analysis, Super node, Mesh Analysis, Super mesh, Star – Delta Transformation. [Text 1: Chapter 4,5, 7]		06
Chapter 2: Network Theorems Homogeneity, Superposition and Linearity, Thevenin's & Norton's Theorems, Maximum Power Transfer Theorem, Miller's theorem, Reciprocity principle. [Text 1 : Chapter 5]		08
Chapter 3: Network topologies Graph of a network, Concept of tree and co-tree, incidence matrix, tie set and cut set schedules, Formulation of Equilibrium equations in matrix form, Solution of resistive networks. [Text 1: Chapter 5]		04

 KLE Technological University Creating Value Leveraging Knowledge Earlier known as B. V. B. College of Engineering & Technology	FORM ISO 9001: 2008 – BVBCET School of Electronics	Document #: FMCD2005	Rev: 1.0
			Title: Curriculum structure semester wise Electronics and Communication Engineering

Unit II	
Chapter 4: Two Port Networks Two port variables, Z,Y, H,G, A- Parameter representations, Input and output impedance calculation, Series, Parallel and Cascade network connections, and their (suitable) models. [Text 2 : Chapter 11]	06
Chapter 5: Time and Frequency domain Representation of Circuits Order of a system, Concept of Time constant, System Governing equation, System Characteristic equation, Initial conditions, Transfer Functions (Fourier and Laplace domain representation) [Text 2: Chapter 4]	06
Chapter 6: First order circuits Transient response of R-C and R-L networks (with Initial conditions) Concept of phasor, Phasor diagrams, Frequency response characteristics, Polar plots R-C , R-L circuits as differentiator and integrator models, time and frequency domain responses R-C , R-L circuits as Low pass and high pass filters [Text 2: Chapter 5, Text 1: Chapter 8,9,10]	08
Unit III	
Chapter 7: Higher order circuits Higher order R-C,R-L, and R-L-C networks, time domain and frequency domain representation, Phasor diagrams, Polar and logarithmic plots, Series R-L-C circuit, Transient response, Damping factor, Quality factor, Frequency response curve, Peaking of frequency curve and its relation to damping factor, Resonance Parallel, R-L-C circuit, Tank circuit, Resonance, Quality factor and Bandwidth [Text 2: Chapter 7,8]	12

Text Books

1. W H Hayt, J E Kemmerly, S M Durban, “Engineering Circuit Analysis” McGraw Hill Education; Eighth edition ,2013
2. M E. Van Valkenburg, Network Analysis, Third edition Pearson Education, 2019

Reference

1. Joseph Edminister, Mahmood Nahavi, Electric Circuits, 5th edition, McGraw Hill Education, 2017
2. V. K. Aatre, —Network Theory and Filter Design, 3rd edition, New Age International Private Limited, 2014

Program: III Semester Bachelor of Engineering (Electronics & Communication Engineering)	
--	--

Course Title: Analog Electronic Circuits	Course Code: 15EECC202
---	-------------------------------

 KLE Technological University Creating Value Leveraging Knowledge Earlier known as B. V. B. College of Engineering & Technology	FORM ISO 9001: 2008 – BVBCET School of Electronics	Document #: FMCD2005	Rev: 1.0
	Title: Curriculum structure semester wise Electronics and Communication Engineering		Page 10 of 92 Year:

L-T-P: 4-0-0	Credits: 4	Contact Hours: 4Hrs/week	Teachig Hours
ISA Marks: 50	ESA Marks: 50	Total Marks: 100	
Teaching Hours: 50Hrs	Examination Duration: 3 Hrs		
Unit I			
Chapter 1: Applications of a Junction diode: Recap of diode models: piece-wise linear model, constant voltage drop model, ideal diode model, small signal model. Applications of diodes as a Clipping circuit and clamping circuits Voltage doubler. (T1 : 2.2,2.3.1 to 2.3.8,2.6.1to 2.6.3.)			06
Chapter No. 2.Bipolar junction transistors. The common emitter characteristics,Dependence of Ic on the collector voltage-the early effect large signal operation-the transfer characteristics, the amplifier gain, operation as a switch. DC load line and bias point, base- bias, collector to base bias, voltage divider, comparison of bias circuit, small signal models of bipolar transistors, two port modeling of amplifiers, ac analysis of BJT circuits-coupling and bypass capacitor. Common emitter circuit analysis, CE circuit with un-bypassed emitter resistor. (T1: 3.1.1, 3.2.1,3.2.2, 3.2.3, 3.2.4, 3.3.1, 3.3.2, 3.3.4)			07
Chapter 3: MOSFETs structure and physical operation: Device structure, operation with no gate voltage, creating a channel for current flow, applying small vds, operation as vds is increased, derivation of the id-vds relationship, the P-channel MOSFET, complementary MOS or CMOS, operating the mos transistor in the sub threshold region.Current-voltage characteristics: circuit symbol, the id vs vds characteristics, finite output resistance in saturation, characteristics of the p-channel MOSFET, the role of the substrate-the body effect, temperature effects, breakdown and input protection. MOSFET circuits at DC. (T1: 4.1, 4.2 ;4.3)			07
Unit II			
Chapter 4: Biasing of MOSFETs MOSFET circuits at DC. Biasing in mos amplifier circuits,:By fixing VGS;By fixing VG;With drain to gate feedback resistor;Constant current source biasing and Numericals (T1:4.3)			08
Chapter 5: MOSFET amplifiers Biasing in mos amplifier circuits, small signal operation and models, single stage MOS amplifiers, the MOSFET internal capacitance and high frequency model, frequency response of CS amplifier.(CD and CG),Cascode Connection: Implications on gain and Bandwidth (T1:4.4,4.5, 4.6.1 to 4.6.7 ; 4.7.1, 4.7.2, 4.7.3, 4.7.5, 4.7.6, 4.7.7;4.8.1,4.8.2, 4.8.3,4.8.4, 4.9.1 to 4.9.3)			12
Unit III			
Chapter 6: Feedback Amplifiers : General feedback structure (Block schematic), Feedback desensitivity factor, positive and negative feedback Nyquist stability Criterion, RC phase shift oscillator, wein bridge Oscr, merits of negative feedback, feedback topologies: series-shunt feedback amplifier, series-series feedback amplifier, and shunt-shunt and shunt-series feedback amplifier with examples (T1:7.1 to 7.6)			05
Chapter 7: Large Signal Amplifiers : Classification of amplifiers: (A, B, AB and C); Transformer coupled amplifier, push-pull amplifier Transistor case and heat sink. (T1:12.1 to 12.6;12.8.4) B. V. Bhoomaraddi College Campus, Vidyanagar, Hubballi 580031. Karnataka (India)			05

 KLE Technological University Creating Value Leveraging Knowledge Earlier known as B. V. B. College of Engineering & Technology	FORM ISO 9001: 2008 – BVBCET School of Electronics	Document #: FMCD2005	Rev: 1.0
			Year:

Text Books

1. A.S. Sedra & K.C. Smith, "Microelectronic Circuits", 7th edition, Oxford University Press, 2017

Reference

1. Jacob Millman and Christos Halkias, -Integrated Electronics "McGraw Hill Education, 2nd edition 2017
2. David A. Bell, -Electronic Devices and Circuits, Oxford Fifth edition 2008
3. Grey, Hurst, Lewis and Meyer, -Analysis and design of analog integrated circuits, Wiley, 5th edition 2009
4. Thomas L. Floyd, -Electronic devices, Pearson, 10th edition, 2018
5. Richard R. Spencer & Mohammed S. Ghousi, — Introduction to Electronic Circuit Design, Pearson Education, 2003
6. J. Millman & A. Grabel, "Microelectronics" -2nd edition, McGraw Hill, 2017
7. Behzad Razavi, -Fundamentals of Microelectronics, 2nd edition Wiley; 2013

Program: III Semester Bachelor of Engineering (Electronics & Communication Engineering)			Teaching Hours
Course Title: Digital Circuits		Course Code: 19EECC201	
L-T-P: 4-0-0	Credits: 4	Contact Hours: 4Hrs/week	
ISA Marks: 50	ESA Marks: 50	Total Marks: 100	
Teaching Hours: 50 Hrs	Examination Duration: 3 Hrs		

 KLE Technological University Creating Value Leveraging Knowledge Earlier known as B. V. B. College of Engineering & Technology	FORM ISO 9001: 2008 – BVBCET School of Electronics	Document #: FMCD2005	Rev: 1.0
			Title: Curriculum structure semester wise Electronics and Communication Engineering

Unit-I Chapter No. 1. Logic Families Logic levels, output switching times, fan-in and fan-out, comparison of logic families	03
Chapter No. 2. Principles of Combinational Logic Definition of combinational logic, canonical forms, Generation of switching equations from truth tables, Karnaugh maps-3,4 variables, Incompletely specified functions(Don't care terms),Simplifying Maxterm equations, Quine-McCluskey minimization technique- Quine-McCluskey using don't care terms, Reduced Prime Implicant Tables.	10
Chapter No. 3. Analysis and design of combinational logic General approach, Decoders-BCD decoders, Encoders, Digital multiplexers- Using multiplexers as Boolean function generators. Adders and subtractors-Cascading full adders, Look ahead carry adders, Binary comparators.	08
Unit-II Chapter No. 4.Introduction to Sequential Circuits Basic Bistable Element, Latches, A SR Latch, Application of SR Latch, A Switch De bouncer, The SR Latch, The gated SR Latch, The gated D Latch, The Master-Slave Flip-Flops (Pulse-Triggered Flip-Flops): The Master-Slave SR Flip-Flops, The Master-Slave JK Flip-Flop, Edge Triggered Flip- Flop: The Positive Edge-Triggered D Flip-Flop, Negative-Edge Triggered D Flip-Flop; Characteristic Equations	10
Chapter No. 5. Analysis of Sequential Circuits Registers and Counters, Binary Ripple Counters, Synchronous Binary counters, Ring and Johnson Counters, Design of a Synchronous counters, Design of a Synchronous Mod-n Counter using clocked JK Flip-Flops Design of a Synchronous Mod-n Counter using clocked D, T or SR Flip-Flops.	10
Unit-III Chapter No. 6. Sequential Circuit Design Introduction to Sequential Circuit Design, Mealy and Moore Models, State Machine notations, Synchronous Sequential Circuit Analysis, Construction of state Diagrams and counter design.	05
Chapter No. 7. Introduction to memories Introduction and role of memory in a computer system, memory types and terminology, Read Only memory, MROM, PROM, EPROM, EEPROM, Random access memory, SRAM, DRAM, NVRAM.	04

 KLE Technological University <small>Creating Value Leveraging Knowledge</small> Earlier known as B. V. B. College of Engineering & Technology	FORM ISO 9001: 2008 – BVBCET School of Electronics	Document #: FMCD2005	Rev: 1.0
Title: Curriculum structure semester wise Electronics and Communication Engineering			Page 13 of 92 Year:

Text Books

1. Donald D Givone, Digital Principles and Design, McGraw Hill Education ,2017
2. John M Yarbrough, Digital Logic Applications and Design, 1st edition Cengage Learning, 2006
3. A AnandKumar , Fundamentals of digital circuits 4th Revised edition, PHI ,2016

References

1. Charles H Roth, Fundamentals of Logic Design, 7th edition
, Cengage Learning, 2015
2. Zvi Kohavi, Switching and Finite Automata Theory Cambridge
University Press; 3 edition October 2009
3. R.D. Sudhaker Samuel, Logic Design, Pearson Education ,2010
4. R P Jain, Modern Digital Electronics , 4th edition, McGraw Hill Education, 2009

 KLE Technological University Creating Value Leveraging Knowledge Earlier known as B. V. B. College of Engineering & Technology	FORM ISO 9001: 2008 – BVBCET School of Electronics	Document #: FMCD2005	Rev: 1.0
			Title: Curriculum structure semester wise Electronics and Communication Engineering

Program: III Semester Bachelor of Engineering (Electronics & Communication Engineering)			Teaching Hours
Course Title: Signals and Systems		Course Code: 19EECC202	
L-T-P: 4-0-0	Credits: 4	Contact Hours: 4Hrs/week	
ISA Marks: 50	ESA Marks: 50	Total Marks: 100	
Teaching Hours: 50Hrs	Examination Duration: 3 Hrs		
Unit I			
Chapter No. 01: Signal Representation Definition of a signals and systems, classification of signals,(analog and discrete signal, periodic and aperiodic, deterministic and random signals, even and odd signals, energy and power) , basic operation on signals(independent variable, dependent variable , time scaling, multiplication, time reversal), elementary signals (Impulse, step, ramp, sinusoidal, complex exponential), Systems Interconnections(series, parallel and cascade), properties of linear systems. (homogeneity ,superposition, linearity and time invariance, stability, memory, causality)		10	
Chapter No. 02 : LTI System Representation Impulse response representation and properties, Convolution, convolution sum and convolution integral. Differential and difference equation Representation, Block diagram representation		10	
Unit II			
Chapter No. 03:Fourier representation for signals Introduction, Discrete time Fourier series(derivation of series excluded) and their properties. Discrete Fourier transform (derivation of transform excluded) and properties		10	
Chapter No. 04:Applications of Fourier transform Introduction, frequency response of LTI systems, Fourier transform representation of periodic signals, Fourier transform representation of discrete time signals. Sampling of continuous time signals.		10	
Unit III			
Chapter No. 05: Z-transform Definition of z-transform, Properties of ROC, Properties of Z-transforms: Inverse z-transforms (Partial Fraction method, long division method), Unilateral Z-transform, Transform of LTI.		10	
Text Book (List of books as mentioned in the approved syllabus) <ol style="list-style-type: none"> 1. Simon Haykin and Barry Van Veen , Signals and Systems, 2nd edition Wiley,2007 2. Alan V Oppenheim ,Alan S Willsky and S. Hamid Nawab , Signals and Systems, Second, PHI public,1997 			
References <ol style="list-style-type: none"> 1. H. P Hsu, R. Ranjan, Signals and Systems ,; 2nd edition, McGraw Hill ,2017 2. GaneshRaoandSatishtunga,,SignalSandSystems1st edition, Cengage India, 2017 3. M.J.Roberts, Fundamentals of Signals and Systems 2nd edition, McGraw Hill Education, 2017 			

 KLE Technological University Creating Value Leveraging Knowledge Earlier known as B. V. B. College of Engineering & Technology	FORM ISO 9001: 2008 – BVBCET School of Electronics	Document #: FMCD2005	Rev: 1.0
			Page 15 of 92 Year:
Title: Curriculum structure semester wise Electronics and Communication Engineering			

III Semester Bachelor of Engineering (Electronics & Communication Engineering)

Digital Circuits Laboratory Experiments(15EECP201)

ISA Marks: 80 **ESA Marks: 20** **Total Marks: 100**

Teaching Hours: 24Hrs **Contact Hours: 2Hrs/week**

List of Experiments:

1. Characterization of TTL Gates– Propagation delay, Fan-in, Fan-out and NoiseMargin.
2. To verify of Flipflops (a) JK Master Slave (b) T-type and (c)D-Type
3. Design and implement binary to gray, gray to binary, BCD to Ex-3 and Ex-3 to BCD codeconverters.
4. Design and implement BCD adder and Subtractor using 4 bit paralleladder.
5. Design and implement n bit magnitude comparator using 4- bitcomparators.
6. Design and implement Ring and Johnson counter using shiftregister.
7. Design and implement mod-6 synchronous and asynchronous counters using flip flops.
8. Design and implement given functionality using decodersandmultiplexers.
9. Design and implement a digital system to display a 3 bit counter on a 7 segment display. Demonstrate the results on a general purposePCB.

****Note-All above experiments are to be conducted along with simulation.**

***Digital Circuits Lab:** Simulation of combinational and sequential circuits using netlist based Spice Simulators (Avoid using drag n drop), before implementing the circuits on breadboard.

Reference Books

1. K.A.Krishnamurthy-Digital labprimerll, Pearson Education Asia Publications, 2003.
2. A.P. Malvino, -Electronic Principles 7th edition, McGraw Hill Education,2017

 KLE Technological University Creating Value Leveraging Knowledge Earlier known as B. V. B. College of Engineering & Technology	FORM ISO 9001: 2008 – BVBCET School of Electronics	Document #: FMCD2005	Rev: 1.0
			Title: Curriculum structure semester wise Electronics and Communication Engineering

III Semester Bachelor of Engineering (Electronics & Communication Engineering)		
Analog Electronics Laboratory Experiments(15EECP202)		
ISA Marks: 80	ESA Marks: 20	Total Marks: 100
Teaching Hours: 24Hrs	Contact Hours: 2Hrs/week	
List of Experiments: Exercise <ol style="list-style-type: none"> Design &Testing of Diode Clipping (single/double ended)circuits Design &Testing of Clamping circuits for Positive and NegativeClamping. Design &Testing of BJT as aswitch MOSFETcharacteristics Design &Testing of MOSFET as aswitch Design and testing Current mirror circuit withMOSFET Design and testing of Transformer-less push-pull class B poweramplifier Structured Enquiry <ol style="list-style-type: none"> Design and study of single stage Common Emitter BJTamplifier. <ol style="list-style-type: none"> Design and study of CS Amplifier usingMOSFET. Voltage series feedback Open Ended <ol style="list-style-type: none"> Design a regulated power supply for the givenspecifications. <p>**Note-All above experiments are to be conducted along with simulation.</p> <p>*Analog Electronic Circuits Lab: Simulation of MOSFET based circuits using netlist based Spice Simulators (Avoid using drag n drop), with the spice models of MOSFETs in the same netlist file before using hardware usingbreadboard.</p>		
Reference Books <ol style="list-style-type: none"> “Electronic Devices & circuit Theory — by Nashelsky& Boylstead,11th Edition, Pearson, 2015 “Integrated Electronics”—By_JacobMillmanand Christos Halkias ,McGraw Hill Education; 2nd edition 2017 “Electronic Principles” by A.P. Malvino,7th edition, McGraw Hill Education,2017 		

 KLE Technological University Creating Value Leveraging Knowledge Earlier known as B. V. B. College of Engineering & Technology	FORM ISO 9001: 2008 – BVBCET School of Electronics	Document #: FMCD2005	Rev: 1.0
			Title: Curriculum structure semester wise Electronics and Communication Engineering

Program: III Semester Bachelor of Engineering (Electronics & Communication Engineering)		
Laboratory Experiments		
Laboratory Title: Microcontroller Architecture & Programming		Lab. Code: 21EECF202
ISA Marks: 80	ESA Marks: 20	Total Marks: 100
Teaching Hours: 72 Hrs	Contact Hours: 6 Hrs/week	Credits: 0-0-3
Unit - I		
Chapter 1: Microprocessors and microcontroller Introduction, Microprocessors and Microcontrollers, A Microcontroller Survey, RISC & CISC CPU Architectures, Harvard & Von-Neumann CPU architecture.		
Chapter 2: The 8051 Architecture 8051 Microcontroller Hardware, Input / Output Pins, Ports and Circuits, semiconductor Memories, Interfacing external RAM & ROM memories.		
Chapter 3: Addressing Modes and Arithmetic Operations Addressing modes, External data Moves, Code Memory, Read Only Data Moves / Indexed Addressing mode , Data exchanges, stack concept and related instructions ,example programs. Logical Operations: Introduction, Byte level, logical Operations, Bit level Logical Operations , Rotate and Swap Operations, Example Programs, Arithmetic Operations: Introduction, Flags, Incrementing and Decrementing, Addition, Subtraction Multiplication and Division, Decimal Arithmetic, Example Programs.		
Unit – II		
Chapter 4 Branch operations Jump Operations: Introduction, The JUMP and CALL ,Program range, Jump calls and Subroutines ,Interrupts and Returns,Example Problems.		
Chapter 5: 8051 Programming in ‘C’ Data Types and Time delays in 8051C,I/O Programming,Logic operations,Data Conversion programs,Accessing code ROM space,. Data serialization.		
Chapter 6: Counter/Timer Programming in 8051 Programming 8051 Timers, Programming Timer0 and Timer1 in 8051C		
Unit – III		
Chapter 7: Serial Communication Basics of Serial Communication, 8051 connections to RS-232,8051 Serial Communication modes, Programming, Serial port programming in C.		
Chapter 8: 8051 interfacing and applications Interfacing 8051 to LCD, Keyboard, ADC, DAC, Stepper Motor, DC Motor.		4 hours
Chapter 9: Interrupts Introduction to interrupts, interrupts vs polling, classification of interrupts, interrupt priority, interrupt vector table, interrupt service routine		2 hours

 KLE Technological University Creating Value Leveraging Knowledge Earlier known as B. V. B. College of Engineering & Technology	FORM ISO 9001: 2008 – BVBCET School of Electronics	Document #: FMCD2005	Rev: 1.0
			Title: Curriculum structure semester wise Electronics and Communication Engineering

Text Book

- " *The 8051 Microcontroller Architecture, Programming & Applications* " by ' Kenneth J. Ayala', Penram International, 1996
- " *The 8051 Microcontroller and Embedded systems* ", by ' Muhammad Ali Mazidi and Janice Gillispie Mazidi', Pearson Education, 2003

References

- " *Programming and Customizing the 8051 Microcontroller* ", by 'Predko', TMH.

Program: III Semester Bachelor of Engineering (Electronics & Communication Engineering)		
Laboratory Experiments		
Laboratory Title: C Programming (for Diploma)		Lab. Code: 18EECF204
ISA Marks: 80	ESA Marks: 20	Total Marks: 100
Teaching Hours: 52 Hrs	Contact Hours: 4 Hrs/week	Credits: 0-0-2

1. List of experiments/jobs planned to meet the requirements of the course.

Expt./Job No.	Experiment/job Details	No. of Lab. Session/s per batch (estimate)
1.	Write a C program to perform addition , subtraction , multiplication and division of two numbers .	01
2.	Write a C program to i) Identify greater number between two numbers using C program. ii) To check a given number is Even or Odd .	01
3.	Write a C program to i) To find the roots of a quadratic equation. ii) Find the factorial of given number.	01
4.	Write a C program to i) To find the sum of n natural numbers. ii) Print the sum of 1 + 3 + 5 + 7 + + n	01
5.	Write a C program to i) Print the pattern . * * * * * * * * * *	01

 KLE Technological University Creating Value Leveraging Knowledge Earlier known as B. V. B. College of Engineering & Technology	FORM ISO 9001: 2008 – BVBCET School of Electronics	Document #: FMCD2005	Rev: 1.0
Title: Curriculum structure semester wise Electronics and Communication Engineering			Page 19 of 92 Year:

	* * * * * ii) Print the pattern 1 1 2 1 2 3 1 2 3 4 1 2 3 4 5	
6.	Write a C program to To test whether the given character is Vowel or not. (using switch case)	01
7.	Write a C program to To accept 10 numbers and make the average of the numbers using one dimensional array.	01
8.	Write a C program to Find out square of a number using function.	01
9	Write a C program to To find the summation of three numbers using function.	01
10	Write a C program to Find out addition of two matrices.	01

1. Materials and Resources Required:

Text Book

1. Programming in ANSI C, E Balagurusamy

 KLE Technological University Creating Value Leveraging Knowledge Earlier known as B. V. B. College of Engineering & Technology	FORM ISO 9001: 2008 – BVBCET School of Electronics	Document #: FMCD2005	Rev: 1.0
			Title: Curriculum structure semester wise Electronics and Communication Engineering

Program: IV Semester Bachelor of Engineering (Electronics & Communication Engineering)			Teaching Hours
Course Title: Linear Algebra and Partial Differential Equations		Course Code: 17EMAB208	
L-T-P-SS: 4-0-0-0	Credits: 4	Contact Hours: 4Hrs/week	
ISA Marks: 50	ESA Marks: 50	Total Marks: 100	
Teaching Hours: 50Hrs	Examination Duration: 3 Hrs		
Unit I			
Chapter1: Partial differential equations			10
Introduction, classification of PDE, Formation of PDE, Solution of equation of the type $Pp + Qq = R$, Solution of partial differential equation by direct integration methods, method of separation of variables. Modeling: Vibration of string-wave equation, heat equation. Laplace equation. Solution by method of separation of variables.			
Chapter2: Finite difference method			10
Finite difference approximations to derivatives, finite difference solution of parabolic PDE, explicit and implicit methods; Hyperbolic PDE-explicit method, Elliptic PDE-initial-boundary Value problems..			
Unit II			
Chapter3: Fourier Series			10
Complex Sinusoids, Fourier series representations of four classes of signals, Periodic Signals: Fourier Series representations, Derivation of Complex Co-efficients of Exponential Fourier Series and Examples. Convergence of Fourier Series. Amplitude and phase spectra of a periodic signal. Properties of Fourier Series (with proof): Linearity, Symmetry Properties, Time shift, Frequency Shift, Scaling, Time differential differentiation coefficients, Time domain Convolution, Multiplication Theorem, Parseval's theorem and Examples on these properties.			
Chapter 4: Fourier Transform			10
Fourier representation of non-periodic signals, Magnitude and phase spectra. Properties of Fourier Transform: Linearity, Symmetry Properties, Time shift, Frequency Shift, Scaling, Time differential differentiation coefficients, Time domain Convolution, Multiplication Theorem, Parseval's theorem and Examples on these properties.			
Unit III			
Chapter5: Complex analysis		Function of	05
complex variables. Limits, continuity and differentiability. Analytic functions, C-R equations in Cartesian and polar forms, construction of Analytic functions (Cartesian and polar forms).			
Chapter 7: Complex Integration			05
Line integral, Cauchy's theorem- corollaries, Cauchy's integral formula. Taylor's and Laurent Series, Singularities, Poles, Residue theorem – problems.			

 KLE Technological University Creating Value Leveraging Knowledge Earlier known as B. V. B. College of Engineering & Technology	FORM ISO 9001: 2008 – BVBCET School of Electronics	Document #: FMCD2005	Rev: 1.0
Title: Curriculum structure semester wise Electronics and Communication Engineering			Page 21 of 92 Year:

Text Book

1. Simon Haykin, Barry Van Veen, Signals and Systems, 2nd edition, Wiley, 2007
2. Peter V. O'neil, Advanced Engineering Mathematics Cengage Learning Custom Publishing; 7th Revised edition 2011
3. Dennis G Zill and Michael R Cullin, "Advanced Engineering Mathematics", 4th edition, Narosa Publishing House, New Delhi, 2012

References

1. Kreyszig E., Advanced Engineering Mathematics, 10th edition, Wiley, 2015
2. Stanley J Farlow, Partial differential equations for Scientists and Engineers, Dover publications, INC, New York, 1993

 KLE Technological University Creating Value Leveraging Knowledge Earlier known as B. V. B. College of Engineering & Technology	FORM ISO 9001: 2008 – BVBCET School of Electronics	Document #: FMCD2005	Rev: 1.0
			Year: 2017-21

Program: IV Semester Bachelor of Engineering (Electronics & Communication Engineering)			Teaching Hours
Course Title: Electromagnetic Fields and Waves		Course Code: 21EECC209	
L-T-P: 3-0-0	Credits: 3	Contact Hours: 3 Hrs/week	
ISA Marks: 40	ESA Marks: 50	Total Marks: 100	
Teaching Hours: 50Hrs	Examination Duration: 3 Hrs		
Content			Hrs
Unit – 1			
Chapter No. 1. Electrostatic Fields Introduction, Coulomb's Law and Field Intensity, Electric Fields Due to Continuous Charge Distribution, Electric Flux Density, Gauss's Law – Maxwell's Equation, Application of Gauss's Law, Electric Potential, Relationship between E and V – Maxwell's Equation, An Electric Dipole and Flux Lines, Energy Density in Electrostatic Fields.			5 hrs
Chapter No. 2. Electric Fields in Material Space Introduction, Properties of materials, Convection and Conduction Currents, Conductors, Polarization in Dielectrics, Dielectric Constant and strength, Continuity Equation and Relaxation Time, Boundary Conditions.			5 hrs
Chapter No. 3. Electrostatic Boundary-Value Problems Introduction, Poisson's and Laplace's Equations, Uniqueness Theorem, General Procedure for Solving Poisson's or Laplace's Equation, Resistance and Capacitance, Method of Images.			5 hrs
Unit - 2			
Chapter No. 4. Magnetostatic Fields Introduction, Biot-Savart's Law, Ampere's Circuit Law—Maxwell's Equation, Applications of Ampere's Law, Magnetic Flux Density—Maxwell's Equation, Maxwell's Equations for Static EM Fields, Magnetic Scalar and Vector Potentials, Derivation of Biot-Savart's Law and Ampere's Law.			6 hrs
Chapter No. 5. Magnetic Forces, Materials and Devices Introduction, Forces due to Magnetic Fields, Magnetic Torque and Moment, A Magnetic Dipole, Magnetization in Materials, Classification of Magnetic Materials, Magnetic Boundary Conditions, Inductors and Inductances, Magnetic Energy, Magnetic Circuits, Force on Magnetic Materials			6 hrs
Chapter No. 6. Maxwell's Equations Introduction, Faraday's Law, Transformer and Motional Electromotive Forces, Displacement Current, Maxwell's Equations in Final Forms, Time-Varying Potentials, Time-Harmonic Fields.			3 hrs
Unit - 3			
Chapter No. 7. Electromagnetic Wave Propagation Introduction, Wave Propagation in Lossy Dielectrics, Plane Waves in Lossless Dielectrics, Plane Waves in Free Space, Plane Waves in Good Conductors, Power and the Poynting Vector, Reflection of a Plane Wave at Normal Incidence, Reflection of a Plane Wave at Oblique Incidence.			5 hrs
Chapter No. 8. Transmission Lines Introduction, Transmission Line Parameters, Transmission Line Equations, Input Impedance, SWR, and Power, The Smith Chart, Transients on Transmission Lines, Microstrip Transmission Lines, Some Applications of Transmission Lines.			5 hrs

Text Book (List of books as mentioned in the approved syllabus) <ol style="list-style-type: none"> 1. William Hayt. Jr. John A. Buck, Engineering Electromagnetics ,9thedition,McGraw Hill Education,2018. 2. R. K. Shevgaonkar, Electromagnetic Waves McGraw Hill Education; 1st edition,2017 3. Mathew N. O. Sadiku, Elements of Electromagnetics; Sixth edition, Oxford University , 2015
--

 KLE Technological University Creating Value Leveraging Knowledge Earlier known as B. V. B. College of Engineering & Technology	FORM ISO 9001: 2008 – BVBCET School of Electronics	Document #: FMCD2005	Rev: 1.0

Program: IV Semester Bachelor of Engineering (Electronics & Communication Engineering)			Teaching Hours
Course Title: Linear Integrated circuits		Course Code:19EECC203	
L-T-P: 4-0-0	Credits: 4	Contact Hours: 4Hrs/week	
ISA Marks: 50	ESA Marks: 50	Total Marks: 100	
Teaching Hours: 50Hrs	Examination Duration: 3 Hrs		
Unit I			
Chapter No 1. Current Mirrors Current Mirror circuits, Current source and current sink, Figures of merit (output impedance, voltage swing), Widlar, Cascode and Wilson current Mirrors.		4	
Chapter No 2. . Basic OPAMP architecture Basic differential amplifier, Common mode and difference mode gain, CMRR, 5-pack differential amplifier with design, 7-pack operational amplifier, Slew rate limitation, Bandwidth and frequency response curve.		6	
Chapter No 3. OPAMP characteristics Ideal and non-ideal OPAMP terminal characteristics, Input and output impedance, output Offset voltage, Small signal and Large signal bandwidth.		8	
Unit II			
Chapter No 4. OPAMP with Feedback OPAMP under Positive and Negative feedback, Impact Negative feedback on Bandwidth, Input and Output impedances, Offset voltage under negative feedback, Follower property & Inversion Property under linear mode operation		10	
Chapter No 5. Linear applications of OPAMP DC and AC Amplifier, Summing, Scaling and Averaging amplifiers (Inverting, Non-inverting and Differential configuration), Instrumentation amplifier, Integrator, Differentiator, Active Filters –First and second order Low pass & High pass filters. V to I and I to V converters.		12	
Unit III			
Chapter No 6. Nonlinear applications of OPAMP Crossing detectors (ZCD. Comparator), Inverting Schmitt trigger circuits, Triangular/rectangular wave generators, Waveform generator, Voltage controlled Oscillator, Sample and Hold circuits, Phase Shift Oscillator, Wein Bridge Oscillator, Data Converters: Digital to Analog Converters: Weighted resistor R -2R DAC, Current steering DAC, Pipeline DAC, Analog to Digital Converters: Flash, Pipeline ADC, SAR		10	

 KLE Technological University Creating Value Leveraging Knowledge Earlier known as B. V. B. College of Engineering & Technology	FORM ISO 9001: 2008 – BVBCET School of Electronics	Document #: FMCD2005	Rev: 1.0
Title: Curriculum structure semester wise Electronics and Communication Engineering			Page 24 of 92 Year: 2017-21

Text Book

1. Behzad Razavi, Fundamentals of Microelectronics 2nd edition, Wiley, 2013
2. Phillip E. Allen, Douglas R. Holberg, CMOS Analog Circuit Design 3rd edition, OUP USA, 2012
3. Ramakant A. Gayakwad, Op - Amps and Linear Integrated Circuits, Pearson Education, 4th edition, 2015

References

1. A.S. Sedra & K.C. Smith, Microelectronic Circuits, 7th edition, Oxford University Press, 2017
2. Sergio Franco, Design with Operational Amplifiers and Analog Integrated Circuits, 3rd edition, MHE, 2012
3. David A. Bell, Operational Amplifiers and Linear IC's, Third edition, Oxford University Press, 2011
4. B. Razavi, Design of Analog CMOS Integrated Circuits, Second edition, McGraw Hill Education, 2017

 KLE Technological University Creating Value Leveraging Knowledge Earlier known as B. V. B. College of Engineering & Technology	FORM ISO 9001: 2008 – BVBCET School of Electronics	Document #: FMCD2005	Rev: 1.0

Program: IV Semester Bachelor of Engineering (Electronics & Communication Engineering)			Teaching Hours
Course Title: Control Systems		Course Code: 15EECC206	
L-T-P: 4-0-0	Credits: 4	Contact Hours: 4Hrs/week	
ISA Marks: 50	ESA Marks: 50	Total Marks: 100	
Teaching Hours: 50Hrs	Examination Duration: 3 Hrs		
Unit I			
Chapter No. 1. Control System Representation Concepts of Control Systems- Open Loop And Closed Loop Control Systems, Feed-Back characteristics, Examples, System representation: Differential Equations, Transfer function, Impulse response, System Modeling: Electrical Mechanical, Electro mechanical, Rotational Mechanical Systems.		6	
Chapter No. 2. Block Diagram And Signal Flow Graphs Transfer Functions, Block Diagram Algebra and Representation by Signal Flow Graph - Reduction Using Mason's Gain Formula.		8	
Chapter No. 3. Time Response Analysis Standard Test Signals (impulse, step, ramp, parabola)-Order and Type of System, Concept of Dominant pole, Time Response of First Order Systems – Characteristic Equation of Feedback Control Systems, Transient Response of Second Order Systems - Time Domain Specifications – Steady State Response - Steady State Errors and Error Constants – Effects Of Proportional Derivative, Proportional Integral Systems		6	
Unit II			
Chapter No. 4. Stability Analysis In S-Domain The Concept Of Stability (BIBO, all system poles on LHS, Impulse response is convergent, Marginal stability- necessary conditions) – Routh's Stability Criterion – Limitations of Routh's Stability Criterion (Applications only). Root Locus Technique: The Root Locus Concept - Construction Of Root Loci.		10	
Chapter No. 5. Frequency Response Analysis Introduction, Bode Diagrams- Determination Of Frequency Domain Specifications And Transfer Function From The Bode Diagram-Phase Margin And Gain Margin-Stability Analysis From Bode Plots, All Pass And Minimum Phase Systems		10	
Unit III			
Chapter No. 6. Stability Analysis In Frequency Domain Polar Plots, Nyquist Plots Stability Analysis, Assessment Of Relative Stability Using Nyquist Criterion.		6	
Chapter No. 7. Introduction to Controller Design The Design Problem. Preliminary Consideration Of Classical Design, Realization Of Basic Compensators (Lag, Lead and dominant pole compensation), P, I, PI, PD & PID Controllers.		6	

 KLE Technological University Creating Value Leveraging Knowledge Earlier known as B. V. B. College of Engineering & Technology	FORM ISO 9001: 2008 – BVBCET School of Electronics	Document #: FMCD2005	Rev: 1.0
Title: Curriculum structure semester wise Electronics and Communication Engineering			Page 26 of 92 Year: 2017-21

Text Books

1. J. Nagrath and M. Gopal, Control Systems Engineering; Sixth edition, New Age International Pvt Ltd 2018
2. B. C. Kuo , Automatic Control Systems, 9th edition, John wiley and Sons,2014

References

1. Katsuhiko Ogata, Modern Control Engineering, 5th edition, Pearson education India Pvt. Ltd,2015,
2. Richord C Dorf and Robert H. Bishop, Modern Control Systems, 13th edition, Pearson; 2016

 KLE Technological University Creating Value Leveraging Knowledge Earlier known as B. V. B. College of Engineering & Technology	FORM ISO 9001: 2008 – BVBCET School of Electronics	Document #: FMCD2005	Rev: 1.0

Program: IV Semester Bachelor of Engineering (Electronics & Communication Engineering)			Teaching Hours
Course Title: ARM Processor & Applications		Course Code: 15EECC207	
L-T-P: 3-0-0	Credits: 3	Contact Hours: 3Hrs/week	
ISA Marks: 50	ESA Marks: - 50	Total Marks: 100	
Teaching Hours: 40Hrs	Examination Duration: 3 Hrs		

Content	
Unit I	
Chapter 1: Introduction to Microprocessor and Microcontroller Microprocessor, Microcontroller, Comparing Microprocessor and Microcontroller, RISC vs. CISC, Von-Neumann vs. Harvard Architecture, Microcontroller Survey, Development systems for microcontroller, Case study: Architecture of 8085/8086 and 8051 Microprocessor and Microcontroller respectively	10
Chapter 2: ARM Architecture Architectural inheritance, Architecture of ARM7TDMI, ARM programmers model, ARM development tools, 3 stage pipeline ARM organization, ARM instruction execution.	06
Chapter 3: Instruction set 1 Introduction, ARM instruction set-Data processing and branch instructions, Arithmetic and example programs Data processing instruction, Branch instruction, Load store instruction, Software interrupt instruction, Program status register instruction, Conditional execution, Example programs	06
Unit II	
Chapter 4: Instruction set 2 The Thumb programmer model, Thumb branch instructions, Thumb software interrupt instructions, Thumb data processing instructions, Thumb breakpoint instruction, Thumb implementation, and Thumb applications. Example programs: The Thumb programmer model, ARM-Thumb interworking, other branch instructions, Data processing instructions, Single/Multiple register load store instruction, Stack operation, Software interrupt instructions, Thumb breakpoint instruction, Thumb implementation, and Thumb applications exampleprograms.	05
Chapter 5: Assembler rules and Directives Introduction, structure of assembly language modules, Predefined register names, frequently used directives, Macros, Miscellaneous assembler features.	03
Chapter 6: Exception handling Introduction, Interrupts, error conditions, processor exception sequence, the vector table, Exception handlers, Exception priorities, Procedures for handling exceptions.	05
Chapter 7: Architectural support for high level languages Abstraction in software design, data types, floating point data types, The ARM floating point architecture, use of memory, run time environment.	05

 KLE Technological University Creating Value Leveraging Knowledge Earlier known as B. V. B. College of Engineering & Technology	FORM ISO 9001: 2008 – BVBCET School of Electronics	Document #: FMCD2005	Rev: 1.0
Title: Curriculum structure semester wise Electronics and Communication Engineering			Page 28 of 92 Year: 2017-21

Unit – III Chapter 8: LPC 2129/2148 Controller Architectural overview On-chip memory, GPIOs, Timers, UART, ADC, I2C, SPI, RTC ARM interfacing techniques and programming: LED, LCD, Stepper Motor, Buzzer, Keypad, ADC	10
Text Book: <ol style="list-style-type: none"> 1. The 8051 Microcontroller Architecture, Programming & Applications " By_KennethJ.Ayala, Cenage Learning; 3rd edition 2007 2. ARMSystem- on-ChipArchitecture llby'SteveFurber', SecondEdition,Pearson,2015 3. ARM Assembly Language fundamentals and Techniques llbyWilliam Hohl,CRC press CRC Press; 2nd edition,2014 References: <ol style="list-style-type: none"> 1. -ARMsystemDeveloper'sGuidell- Hardbound,Publicationdate:2004Imprint:MORGANKAUFFMAN 2. User manual onLPC21XX. 	

 KLE Technological University Creating Value Leveraging Knowledge Earlier known as B. V. B. College of Engineering & Technology	FORM ISO 9001: 2008 – BVBCET School of Electronics	Document #: FMCD2005	Rev: 1.0

Program: IV Semester Bachelor of Engineering (Electronics & Communication Engineering)			Lab+ Teaching Hours
Course Title: Digital System Design using Verilog		Course Code: 15EECC208	
L-T-P: 0-0-2	Credits: 2	Contact Hours: 4Hrs/week	
ISA Marks: 80	ESA Marks:20	Total Marks: 100	
Teaching + Lab. Hours: 48 Hrs	Examination Duration:3 Hrs		
1.	Introduction to verilog: Verilog as hdl, levels of design description, simulation and synthesis, digital design flow.	02+02	
2.	Programming on Data flow description: Structure of data-flow description, data type – vectors. Simple combinational circuit design like decoder, multiplexers, code converters.	02+02	
3.	Programming on Behavioral Descriptions: Behavioral Description highlights, sequential statements. Introduction to Testbench. Design of sequence multiplier, Booth multiplier. Introduction to FPGAs, Synthesis	04+04	
4.	Programming on Structural Descriptions: Highlights of structural Description, Organization of the structural Descriptions, state Machines, Generate, Generic, statements. Design of 16 bit RCA and CLA	02+02	
5.	Programming on Tasks and Functions: Highlights of Tasks, and Functions, FSM, design like counter, Mealy and Moore machine, Sequence Detector.	04+04	
6.	Programming on Interfacing : Interfacing with 7-segment display and push buttons. Interfacing with PS/2 Keyboard and VGA display.	04+04	
7.	Programming on Advanced HDL Descriptions: Block RAMs on an FPGA and understand memory interfacing, File operations in Verilog, File processing examples.	02+04	
8.	Open ended Experiment: Bowling Score Keeper / Floating Point Unit Arithmetic Units/pipelined processor/traffic light controller	06	
Text Book <ol style="list-style-type: none"> Nazeih M. Botros, HDL Programming –Verilog, Dreamtech Press,2006. J.Bhaskar,-AVerilog Primer“; , 3rd edition, Pearson Education India ,2015 References <ol style="list-style-type: none"> SamirPalnitkar,-Verilog HDL,,PearsonEducation,2ndEdition,2003. Thomas andMoorby,-TheVerilogHardwareDescriptionLanguage,,klweracademic publishers,5thedition, 2002. 			

 KLE Technological University Creating Value Leveraging Knowledge Earlier known as B. V. B. College of Engineering & Technology	FORM ISO 9001: 2008 – BVBCET School of Electronics	Document #: FMCD2005	Rev: 1.0

3. Stephen Brown and Zvonko Vranesic, -Fundamentals of Logic Design with Verilog; 2nd edition, McGraw Hill Education 2017.
4. Charles H. Roth, Jr., Lizy Kurian John - Digital System Design using VHDL, Thomson, 2nd Edition, 2008.

Program: IV Semester Bachelor of Engineering (Electronics & Communication Engineering)		
Course Title: Data Acquisition and Control Lab		Course Code: 15EECP203
L-T-P: 0-0-1	Credits: 1	Contact Hours: 2Hrs/week
ISA Marks: 80	ESA Marks: - 20	Total Marks: 100
Teaching Hours: 28 Hrs	Examination Duration: 2 Hrs	
List of Experiments: <ol style="list-style-type: none"> 1. Basic Signal Conditioning Techniques <ol style="list-style-type: none"> a) Inverting and Non Inverting Amplifier using OPAMP. b) Comparator. (ZCD & Schmitt trigger) c) Precision rectifier 2. Realize and verify the performance of Instrumentation Amplifier using op-amp 3. Feedback Concepts: Realize and verify the performance of Wein Bridge Oscillator using op-amp 4. To design and implement the filters for a given specification Obtain the phase and frequency responses of 2nd order, Low pass and High pass filter. 5. To implement and characterize the functional block of ADC and DAC. Realize the following data converters to determine their respective performance parameters. <ul style="list-style-type: none"> • 4-bit R-2R D-A Converter. • 2-Bit flash ADC/4-Bit ADC (Using 0804 IC) 6. System Modeling <ul style="list-style-type: none"> • Realize the system modeling for DC Motor using Quanser Qube 7. To determine System Response of RLC circuits Time domain response of an RLC network and the response parameters of interest (Rise time, Peak overshoot, Overshoot and Settling time) for critical, over and under damped conditions using Labview. Time response using Quanser Qube 8. Stability Analysis To determine the stability of the system depending upon Pole - Zero location. To determine the stability of the system using Bode Plots. 9. Compensation Techniques To determine suitable compensator for the given system (PD, PI, PID Controller using Quanser Qube). 		

 KLE Technological University Creating Value Leveraging Knowledge Earlier known as B. V. B. College of Engineering & Technology	FORM ISO 9001: 2008 – BVBCET School of Electronics	Document #: FMCD2005	Rev: 1.0
Title: Curriculum structure semester wise Electronics and Communication Engineering			Page 31 of 92 Year: 2017-21

10. Structured Enquiry (16+16=32marks)

- MOS Amplifier Design and implementation
- Design and implement a PD control system using Co-simulation.

Text Books:

1. Ramakant Gayakwad, Operational Amplifiers and Linear Integrated Circuits; Fourth edition Pearson Education, 2015
2. Sergio Franco Design with Op-amps and Analog Integrated circuits, MHE; third edition, 2012

References:

1. Dan Sheingold Analog to Digital Conversion Hand Book, 3rd Revised edition PH, 1986. Prentice Hall, 1985
2. David A. Bell, Operational Amplifiers and Linear IC's.; Third edition, Oxford University Press, 2011
3. Sedra and Smith — Microelectronics Circuits, Sixth edition, Oxford University, 2013

 KLE Technological University Creating Value Leveraging Knowledge Earlier known as B. V. B. College of Engineering & Technology	FORM ISO 9001: 2008 – BVBCET School of Electronics	Document #: FMCD2005	Rev: 1.0

Program: IV Semester Bachelor of Engineering (Electronics & Communication Engineering)

ARM Microcontroller Laboratory Experiments(15EECP204)

ISA Marks: 80	ESA Marks: - 20	Total Marks: 100
Teaching Hours: 28Hrs	Examination Duration: 2 Hrs	Contact Hours: 2Hrs/week

List of Experiments:

1. Write a program that displays a value of '_Y' at port 0 and '_N' at port 2 and also generates a square wave of 10Khz with Timer 0 in mode 2 at port pin p1.2 XTAL=22MHz
2. Write a C program that continuously gets a single bit of data from P1.7 and sends it to P1.0 in main, while simultaneously creating a square wave of 200us period on pin P2.5. ii. Sending letter '_A' to serial port. Use Timer 0 to create square wave..
3. Write an ALP to achieve the following arithmetic operations: i. 32 bit addition ii. 64 bit addition iii. Subtraction iv. Multiplication v. 32 bit binary divide
4. Write an ALP for the following using loops: i. Find the sum of '_N' 16 bit numbers ii. Find the maximum/minimum of N numbers iii. Find the factorial of a given number with and without look up table.
5. Write an ALP to i. Find the length of the carriage return terminated string. ii. Compare two strings for equality
6. Write an ALP to pass parameters to a subroutine to find the factorial of a number or prime number generation
7. Write a '_C' program to test working of LED's using LPC2148.
8. Write a '_C' program & demonstrate an interfacing of Alphanumeric LCD 2X16 panel to LPC2148 Microcontroller.
9. Write an ALP to generate the following waveforms of different frequencies i. Square wave ii. Triangular a. iii. Sine wave
10. Write a '_C' program & demonstrate interfacing of buzzer to LPC2148 (using external interrupt)
11. Write a program to set up communication between 2 microcontrollers using I2C.
12. Write a '_C' program & demonstrate an interfacing of ADC
13. Develop an ARM based application using i. sensors ii. actuators iii. Displays

Text Books

1. Steve Furber, ARM System- on-Chip Architecture, 2nd, LPE, 2002
2. The 8051 Microcontroller Architecture, Programming & Applications " By _Kenneth J. Ayala, Cenage Learning; 3rd edition 2007
3. William Hohl ARM Assembly Language fundamentals and Techniques || by, CRC press CRC Press; 2nd edition ,2014

Reference Books

1. -ARM system Developer's Guide || - Hardbound, Publication date: 2004 Imprint: MORGANKAUFFMAN
2. User manual on LPC21XX.

 KLE Technological University Creating Value Leveraging Knowledge Earlier known as B. V. B. College of Engineering & Technology	FORM ISO 9001: 2008 – BVBCET School of Electronics	Document #: FMCD2005	Rev: 1.0

Program: IV Semester Bachelor of Engineering (Electronics & Communication Engineering)			Lab+ Teaching Hours
Course Title: Data Structures Application Lab		Course Code: 21EECF201	
L-T-P: 0-0-2	Credits: 2	Contact Hours: 4Hrs/week	
ISA Marks: 80	ESA Marks:20	Total Marks: 100	
Teaching + Lab. Hours: 48 Hrs	Examination Duration:2 Hrs		
Content			Hrs
Unit - 1			
Chapter No 1. Analysis of algorithms: Introduction, Asymptotic notations and analysis, Analysis of recursive and non-recursive algorithms, master's theorem, complexity analysis of algorithms.			10 hrs
Chapter No 2. Analysis of linear data-structures and its applications: Complexity analysis of basic data structures (Stacks, Queues, Linked lists)			10 hrs
Unit - 2			
Chapter No 3. Analysis of non-linear data-structures and its applications Trees and applications: Computer representation, Tree properties, Binary Tree properties, Binary search trees properties and implementation, Tree traversals, AVL tree. Graphs and applications: Computer representation, Adjacency List, Adjacency Matrix, Graph properties, Graph traversals. Hashing and applications: Hashing, Hash function, Hash Table, Collision resolution techniques, Hashing Applications			28 hrs
Text Books (List of books as mentioned in the approved syllabus)			
1. Richard F. Gilberg & Behrouz A. Forouzan, Data Structures A Pseudocode Approach with C, Second Edition. 2. Aaron M. Tenenbaum, Data Structures Using C.			

 KLE Technological University Creating Value Leveraging Knowledge Earlier known as B. V. B. College of Engineering & Technology	FORM ISO 9001: 2008 – BVBCET School of Electronics	Document #: FMCD2005	Rev: 1.0
			Year: 2017-21

Program: IV Semester Bachelor of Engineering (Electronics & Communication Engineering)			Lab+ Teaching Hours
Course Title: Data Structures using C (Diploma)		Course Code: 21EECF203	
L-T-P: 0-0-3	Credits: 3	Contact Hours: 6Hrs/week	
ISA Marks: 80	ESA Marks:20	Total Marks: 100	
Teaching + Lab. Hours: 72 Hrs	Examination Duration:2 Hrs		

List of experiments/jobs planned to meet the requirements of the course.

Category: Demonstration		Total Weightage: 0.00		No. of lab sessions: 6.00
Expt./ Job No.	Experiment / Job Details	No. of Lab Session(s) per batch (estimate)	Marks / Experiment	Correlation of Experiment with the theory
1	Programs on Pointer concepts.	2.00	0.00	
	<i>Learning Objectives :</i> <i>The students should be able to</i> Perform basic programming structures on 1. Pointers concepts. 2. 1D and 2D arrays. 3. Pointers to functions. 4. Memory management functions			1
2	Programs on string handling functions, structures union And bit-files.	2.00	0.00	
	<i>Learning Outcomes:</i> <i>The students should be able to write programs to:</i> a) Perform string handling functions like 1. String length. 2. String concatenate. 3. Strings compare. 4. String copy. 5. Strings reverse. b) Implement Structures, union and bit-field			1
3	Programming on files.	2.00	0.00	
	<i>Learning Outcomes:</i> <i>The students should be able to write a modular program to:</i>			1

 KLE Technological University Creating Value Leveraging Knowledge Earlier known as B. V. B. College of Engineering & Technology	FORM ISO 9001: 2008 – BVBCET School of Electronics	Document #: FMCD2005	Rev: 1.0

	1. Open and Close the file. 2. Read and Write the file. 3. Append the file.			
Category: Exercise		Total Weightage: 20.00		No. of lab sessions: 12.00
Expt./ Job No.	Experiment / Job Details	No. of Lab Session(s) per batch (estimate)	Marks / Experiment	Correlation of Experiment with the theory
4	Programs on implementation of stacks and its applications.	2.00	3.00	
	<i>Learning Outcomes:</i> <i>The students should be able to:</i> 1. Write a program to Insert delete and display stack elements for an application. 2. Write a program using stack to convert from Infix to postfix & Infix to Prefix 3. Write a program using stack data structure for base conversion.			3
5	Programs on implementation of different queue data structures.	2.00	4.00	
	<i>Learning Outcomes:</i> <i>The students should be able to:</i> Write a program using queue data structure for an application.			3
6	Programs on implementation of different types of Linked lists	2.00	4.00	
	<i>Learning Outcomes:</i> <i>The students should be able to write a modular program to use the linked lists for an application</i> 1. Insert , delete and display a node in SLL. 2. Insert , delete and display a node in DLL. 3. Insert delete and display a node in CLL.			4
7	Programs on Implementation of trees.	2.00	3.00	
	<i>Learning Outcomes:</i> <i>The students should be able to write modular programs to</i>			5

 KLE Technological University Creating Value Leveraging Knowledge Earlier known as B. V. B. College of Engineering & Technology	FORM ISO 9001: 2008 – BVBCET School of Electronics	Document #: FMCD2005	Rev: 1.0
	Title: Curriculum structure semester wise Electronics and Communication Engineering		Page 36 of 92 Year: 2017-21

	1. Perform various operations on binary trees. 2. To find max, min value in a binary search trees. 3. To find the height of a tree, 4. To count nodes in a tree. 5. To delete a node in a tree			
8	Programs to implement different sorting techniques.	2.00	3.00	
	Learning Outcomes: <i>The students should be able to:</i> Write modular program on perform the following sorting techniques 1. Selection 2. Insertion 3. Bubble 4. Merge 5. Quick 6. Heap			5
9	Programming on hash tables	2.00	3.00	
	Learning Outcomes: <i>The students should be able to</i> Write modular program on 1. Direct-address tables 2. Hash tables			6
	Books/References: 1. Aaron M. Tenenbaum, et al, "Data Structures using C", PHI, 2006 2. Cormen, Leiserson, Rivest " Introduction to Algorithms", PHI, 2001 3. E Balaguruswamy, "The ANSI C programming Language", 2ed., PHI, 2010. 4. Yashavant Kanetkar, "Data Structures through C", BPB publications 2010 5. Horowitz, Sahani, Anderson-Feed, "Fundamentals of Data Structures in C", 2ed,Universities Press, 2008 6. Richard F. Gilberg, Behrouz A. Forouzan "Data Structures: A Pseudocode Approach With C", 2 nd Edition , Course Technology, Oct 2009. 7. Kernighan and Ritchie, The ANSI C programming Language, 2 ed., PHI. 8. Robert Kruse, Data Structures and Program Design in C, 2 ed., Pearson			

 KLE Technological University Creating Value Leveraging Knowledge Earlier known as B. V. B. College of Engineering & Technology	FORM ISO 9001: 2008 – BVBCET School of Electronics	Document #: FMCD2005	Rev: 1.0
	Title: Curriculum structure semester wise Electronics and Communication Engineering		Page 37 of 92 Year: 2017-21

Batch 2019-23
Semester: V

No	Code	Course	L-T-P	Credits	Contact Hours	ISA	ESA	Total	Exam Duration
1	19EECC301	PC10:CMOS VLSI Circuits	4-0-0	4	4	50	50	100	3 hours
2	21EECC302	PC11: Communication System I	4-0-0	4	4	50	50	100	3 hours
3	17EECC303	PC12: Digital Signal Processing	4-0-0	4	4	50	50	100	3 hours
4	17EECC304	PC13: Operating System & Embedded Systems Design	3-0-0	3	3	50	50	100	3 hours
5	17EECP301	PCL5: Communication and signal processing Lab	0-0-1	1	2	80	20	100	2 hours
6	17EECP302	PCL6: RTOS Lab	0-0-1	1	2	80	20	100	2 hours
7	19EECP301	PCLx: CMOS VLSI Circuits Lab	0-0-1	1	2	80	20	100	2 hours
8	17EECC307	PC15: Machine Learning	2-0-1	3	4	50	50	100	3 hours
9	17EECW301	P1: Mini Project	0-0-3	3	6	50	50	100	2 hours
TOTAL			17-0-7	24	31	540	360	900	

ISA: In Semester Assessment **ESA:** End Semester Assessment **L:** Lecture **T:** Tutorials **P:** Practical
 HS (Humanities) = H; B(Basic Science) = B; ES(Engineering Science) = F; PC (Program Core) = C;
 EC(Any Elective) = E; PW(Project Work) = W; Research = R; Internship= I; Seminar = S; Colloquium
 = V; Self-study = Y; Specialtopic= T; Apprenticeship = A; Laboratory / Practical = P;Field Work = D;
 and Non-credit course = N.

Semester: VI

No	Code	Course	L-T-P	Credits	Contact Hours	ISA	ESA	Total	Exam Duration
1	16EHSC301	H3: Professional Aptitude and Logical reasoning.	3-0-0	3	3	50	50	100	3 hours
2	17EECC305	PC13:Automotive Electronics	3-0-0	3	3	50	50	100	3 hours
3	17EECC306	PC14:Computer Communication Networks	4-0-0	4	4	50	50	100	3 hours
4	21EECC307	PC11: Communication System II	3-0-0	3	3	50	50	100	3 hours
5	17EECEXXX	PSE Elective 1	3-0-0	3	3	50	50	100	3 hours
6	17EECP303	PCL7: Computer Communication Networks Lab	0-0-1	1	2	80	20	100	2 hours
7	17EECP304	PCL8: Automotive Electronics Lab	0-0-1	1	2	80	20	100	2 hours

 KLE Technological University Creating Value Leveraging Knowledge Earlier known as B. V. B. College of Engineering & Technology	FORM ISO 9001: 2008 – BVBCET School of Electronics	Document #: FMCD2005	Rev: 1.0

8	17EECW302	P2: Minor Project	0-0-6	6	12	50	50	100	2 hours
TOTAL			16-0-8	24	32	460	340	800	

ISA: In Semester Assessment **ESA:** End Semester Assessment **L:** Lecture **T:** Tutorials **P:** Practical
HS (Humanities) = H; **B**(Basic Science) = B; **ES**(Engineering Science) = F; **PC** (Program Core) = C;
EC(Any Elective) = E; **PW**(Project Work) = W; **Research** = R; **Internship**= I; **Seminar** = S; **Colloquium**
 = V; **Self-study** = Y; **Specialtopic**= T; **Apprenticeship** = A; **Laboratory / Practical** = P; **Field Work** = D;
 and **Non-credit course** = N.

Elective VI (Batch 2019-23)

Semester: VI

No	Code	Course: PSE1: Elective	Category	L-T P	Credits	Contact Hours	ISA	ESA	Total	Exam Duration
PSE Elective 1	17EECE301	Analog Circuits Design	PSE	0- 0- 3	3	6	100		100	3Hours
	19EECE322	Introduction to Deep Learning		2- 0- 1		4	50	50		
	17EECE302	Advanced Digital Logic Design		0- 0- 3		3	100			
	17EECE307	Internet of Things		2- 0- 1		4	50	50		
	21EECE308	Information Theory and Coding		3- 0- 0		3	50	50		
	17EECE310	Embedded Intelligence Systems		0- 0- 3		9	80	20		
	20EECE340	Multi core Architecture & Programming		2- 0- 1		4	50	50		
	18EECE421	OOPS using C++		2- 0-		4	50	50		

 KLE Technological University Creating Value Leveraging Knowledge Earlier known as B. V. B. College of Engineering & Technology	FORM ISO 9001: 2008 – BVBCET School of Electronics	Document #: FMCD2005	Rev: 1.0

				1						
--	--	--	--	---	--	--	--	--	--	--

Program: V Semester Bachelor of Engineering(Electronics & Communication Engineering)			Teaching Hours
Course Title: CMOS VLSI Circuits		Course Code: 19EECC301	
L-T-P: 4-0-0	Credits: 04	Contact Hours: 6 Hrs/week	
ISA Marks: 50	ESA Marks: 50	Total Marks: 100	
Teaching Hours: 72 Hrs	Examination Duration: 3 Hrs		
Content			
Unit I			
Chapter No. 1. Introduction to VLSI and IC fabrication technology			
VLSI Design Flow, Semiconductor Technology - An Overview, Czochralski method of growing Silicon, Introduction to Unit Processes (Oxidation, Diffusion, Deposition, Ion-implantation), Basic CMOS technology - Silicon gate process, n-Well process, p-Well process, Twin-tub Process, Oxide isolation. FinFET device, The root cause of short channel effects in twenty-first century MOSFETS, The thin body MOSFET concept, The FinFET and a new scaling path for MOSFETS, Ultra-thin body FET, Recent trends in fabrication technology.			08
Chapter No. 2. Electronic Analysis of CMOS logic gates			
DC transfer characteristics of CMOS inverter, Beta Ratio Effects, Noise Margin, MOS capacitance models. Transient Analysis of CMOS Inverter, NAND, NOR and Complex Logic Gates, Gate Design for Transient Performance, Switch-level RC Delay Models, Delay Estimation, Elmore Delay Model, Power Dissipation of CMOS Inverter, Transmission Gates & Pass Transistors, Tristate Inverter.			14
Unit II			
Chapter No. 3. Design of CMOS logic gates			
Stick Diagrams, Euler Path, Layout design rules, DRC, Circuit extraction, Latch up – Triggering Prevention.			06
Chapter No. 4. Designing Combinational Logic Networks			
Gate Delays, Driving Large Capacitive Loads, Delay Minimization in an Inverter Cascade, Logical effort. Pseudo nMOS, Clocked CMOS, Dynamic CMOS Logic Circuits, Dual-rail Logic Networks: CVSL, CPL.			14

 KLE Technological University Creating Value Leveraging Knowledge Earlier known as B. V. B. College of Engineering & Technology	FORM ISO 9001: 2008 – BVBCET School of Electronics	Document #: FMCD2005	Rev: 1.0
Title: Curriculum structure semester wise Electronics and Communication Engineering			Page 40 of 92 Year: 2017-21

<p style="text-align: center;">Unit – III</p> <p>Chapter No. 5. Sequential CMOS Circuit Design</p> <p style="text-align: center;">Sequencing static circuits, Circuit design of latches and flip-flops, Clocking- clock generation, clock distribution.</p>	08
---	-----------

 KLE Technological University <small>Creating Value Leveraging Knowledge</small> Earlier known as B. V. B. College of Engineering & Technology	FORM ISO 9001: 2008 – BVBCET School of Electronics	Document #: FMCD2005	Rev: 1.0
Title: Curriculum structure semester wise Electronics and Communication Engineering			Page 41 of 92 Year: 2017-21

Text Books (List of books as mentioned in the approved syllabus)

1. John P.Uyemura, Introduction to VLSI Circuits and Systems, 1, Wiley, 2007
2. Neil Weste, David Harris & Ayan Banerjee, CMOS VLSI Design, 4, Pearson Ed 2011
3. Sung-Mo Kang & Yusuf Leblebici, CMOS Digital Integrated Circuits: Analysis and Design, 3, Tata McGra, 2007

References

1. FinFET Modeling for IC Simulation and Design: Using the BSIM-CMG Standard By Yogesh Singh Chauhan, Darsen Duane Lu, Vanugopalan Sriramkumar, Sourabh Khandelwal, Juan Pablo Duarte, Navid Payvadosi, Ai Niknejad, Chenming Hu, Elsevier Publication, 2015
2. Wayne, Wolf, Modern VLSI design: System on Silicon, 3, Pearson Ed, 2005
3. Douglas A Pucknell and Kamran Eshraghian, Basic VLSI Design, 3rd edition, PHI, 2005
4. Phillip. E. Allen, Douglas R. Holberg, CMOS Analog circuit Design, 3rd edition, Oxford University, 2011

 KLE Technological University Creating Value Leveraging Knowledge Earlier known as B. V. B. College of Engineering & Technology	FORM ISO 9001: 2008 – BVBCET School of Electronics	Document #: FMCD2005	Rev: 1.0

Program: V Semester Bachelor of Engineering (Electronics & Communication Engineering)			Teaching Hours
Course Title: Communication Systems I		Course Code: 21EECC302	
L-T-P: 4-0-0	Credits: 4	Contact Hours: 4 Hrs/week	
ISA Marks: 50	ESA Marks: 50	Total Marks: 100	
Teaching Hours: 50Hrs	Examination Duration: 3 Hrs		
Content			
Unit – 1			Hours
Chapter 01. Analog Communication Techniques: Introduction, need for modulation, Amplitude modulation, Time-Domain description, Frequency-Domain description. Generation of AM wave- square law modulator. Detection of AM waves, square law and envelope detector. Double side band suppressed carrier modulation (DSBSC), Generation of DSBSC waves: balanced modulator. Coherent detection of DSBSC modulated waves: Costas loop. Quadrature carrier multiplexing. Single side band modulation, Frequency-Domain and time-domain description of SSB modulated Signals-Generation, detection. Comparison of amplitude modulation techniques, Frequency division multiplexing (FDM).			14 Hours
Chapter 02. Receiver and its characteristics: Radio receivers: Tuned radio frequency receiver, Superheterodyne receiver Sensitivity and selectivity, selection of IF. Block diagram and features of Communication Receiver.			06 Hours
Unit – 2			
Chapter 03. Angle modulation: Basic definitions, Phase and frequency modulation, Phase and frequency Deviation, Narrow and Wide band frequency modulation. Spectrum and phase diagram of FM Transmission band width of FM waves, Effect of Modulation index on bandwidth, Generation of FM Waves: indirect FM, Direct FM, Demodulation of FM Waves,			08 Hours
Chapter 04. Random Variables and processes: Random variables-average, variance, CDF, PDF, Joint CDF and PDF, Random Process- Stationary, Mean, Correlation and Covariance functions., autocorrelation function, Cross-correlation functions. Power spectral density: Properties of the spectral density, Gaussian Process: Central limit theorem, Properties of Gaussian processes.			06 Hours
Chapter 05. Noise in Continuous wave modulation Systems: Sources of noise: Shot noise, thermal noise, White noise. Frequency domain representation, Effect of filtering on Gaussian noise, Mixing and superposition of Noises, Noise equivalent bandwidth, Quadrature components of noise, Narrowband noise, Noise figure., Equivalent noise temperature. Receiver model, Noise in AM Receivers, Noise in FM receivers			06 Hours
Unit - 3			
Chapter 06. Introduction to Sampling: Sampling theorem, Quadrature sampling of Band pass signals, Reconstruction of a message from its samples. Time Division Multiplexing (TDM) Signal distortion in Sampling.			10 Hours

 KLE Technological University Creating Value Leveraging Knowledge Earlier known as B. V. B. College of Engineering & Technology	FORM ISO 9001: 2008 – BVBCET School of Electronics	Document #: FMCD2005	Rev: 1.0
Title: Curriculum structure semester wise Electronics and Communication Engineering			Page 43 of 92 Year: 2017-21

Text book:

1. “Communication Systems” by ‘Simon Haykin’ John Wiley 2003. 5th edition , 2009
2. “Principles of communication Systems”, by Taub & Schilling, 2nd edition , TMH.
3. “Digital communications”, Simon Haykin, John Wiley, 2006

References

4. Communication Systems, by B.P.Lathi ,
5. Ganesh Rao, K N Haribhat, Analog Communication, Sanguine, 2009
6. Communication Systems by Harold. P.E, Stern Samy. A. Mahmond, Pearson Education, 2004.
7. Electronic communication systems, Kennedy and Davis, TMH, Edn. 6, 2012

 KLE Technological University Creating Value Leveraging Knowledge Earlier known as B. V. B. College of Engineering & Technology	FORM ISO 9001: 2008 – BVBCET School of Electronics	Document #: FMCD2005	Rev: 1.0

Program: V Semester Bachelor of Engineering (Electronics & Communication Engineering)		Teaching Hours
Course Title: Digital Signal Processing	Course Code: 17EECC303	
L-T-P: 4-0-0	Credits: 4	
ISA Marks: 50	ESA Marks: 50	
Teaching Hours: 50Hrs	Examination Duration: 3 Hrs	
Content		
Unit - 1		
Chapter No. 1. Discrete Fourier Transforms		12
Brief review of signals and systems: Basic definitions, properties and applications. Discrete Fourier Transforms (DFT): Frequency domain sampling and reconstruction of discrete time signals. DFT as a linear transformation, its relationship with other transforms. Properties of DFT, multiplication of two DFTs- the circular convolution, additional DFT properties, use of DFT in linear filtering, overlap-save and overlap-add method.		
Chapter No. 2. Fast-Fourier-Transform (FFT) algorithms		08
Fast-Fourier-Transform (FFT) algorithms: Direct computation of DFT, Need for efficient computation of the DFT (i.e. FFT algorithms), Radix-2 FFT algorithm for the computation of DFT and IDFT: Decimation-in-time and Decimation-in-frequency algorithms, Composite FFT.		
Unit - 2		
Chapter No. 3. Design of Digital FIR Filters		10
Design of digital filters: Considerations and characteristics of practical digital filters. design of digital filters: symmetric and anti-symmetric FIR filters, design of linear phase FIR filters using windowing method- Rectangular, Hamming, Hanning, Bartlet and Kaiser windows. Design of linear phase FIR filters using frequency sampling technique.		
Chapter No. 4. Design of IIR filters from analog filters		10
Design of IIR filters from analog filters: approximation of derivative, impulse invariance method, bilinear transformation, Characteristics of commonly used analog filters: Butterworth and Chebyshev filters, frequency transformation in the digital domain.		
Unit - 3		
Chapter No. 5. Realization of Digital FIR Systems		05
Implementation of Digital systems: structures for FIR systems: direct form I, direct form II, cascade, frequency sampling and lattice structure, Comparison of the realization techniques.		
Chapter No. 6. Realization of Digital IIR Systems		05
Structures for IIR systems - direct form I, direct form II, cascade, parallel and lattice structure, Comparison of the realization techniques.		

 KLE Technological University Creating Value Leveraging Knowledge Earlier known as B. V. B. College of Engineering & Technology	FORM ISO 9001: 2008 – BVBCET School of Electronics	Document #: FMCD2005	Rev: 1.0
Title: Curriculum structure semester wise Electronics and Communication Engineering			Page 45 of 92 Year: 2017-21

Text Books

1. Proakis & Manolakis, Digital signal processing Principles Algorithms & Applications, 4th edition, PHI, New Delhi,2007
2. S.K. Mitra, Digital Signal Processing, 2nd edition, Tata Mc-Graw Hill,2004

References

1. Oppenheim& Schaffer, Discrete Time Signal Processing, 5th edition, PHI, New Delhi, 2000

 KLE Technological University Creating Value Leveraging Knowledge Earlier known as B. V. B. College of Engineering & Technology	FORM ISO 9001: 2008 – BVBCET School of Electronics	Document #: FMCD2005	Rev: 1.0

Program: V Semester Bachelor of Engineering (Electronics & Communication Engineering)			Teaching Hours
Course Title: Operating System and Embedded System Design		Course Code: 17EECC304	
L-T-P: 3-0-0	Credits: 3	Contact Hours: 3Hrs/week	
ISA Marks: 50	ESA Marks: 50	Total Marks: 100	
Teaching Hours: 40 Hrs	Examination Duration: 3 Hrs		
Unit I			
Chapter 1: Introduction and System structures what is an operating system? Goals of an operating system. Operation of an os .Resource allocation and related functions. Classes of an operating system. Operating System Services . System Calls and Types. Operating system Structure – Simple , Layered, Microkernels, Modules and Hybrid systems. System Boot			03
Chapter 2: Process Management Process concept- operating on process, inter process communication, process scheduling- CPU scheduler- preemptive scheduling , scheduling criteria, scheduling algorithms- first come first served scheduling, shortest job first scheduling, priority scheduling, round robinscheduling.			05
Chapter 3: Memory Management Memory Management Strategies: process address space static vs dynamic loading. Swapping, memory allocation; fragmentation Paging; Structure of page table; Segmentation, Virtual Memory.			06
Unit II			
Chapter 4: Introduction To Real-Time Operating Systems Introduction To Real-Time Operating Systems: Introduction to OS, Introduction to real time embedded system- real time systems, characteristics of real time systems and the future of embedded systems. Introduction to RTOS, key characteristics of RTOS, its kernel, components in RTOS kernel, objects, scheduler, services, context switch, Scheduling types: Preemptive priority-based scheduling, Round-robin and preemptive scheduling.			08
Chapter 5: Tasks, Semaphores and Message Queues: Tasks, Semaphores and Message Queues: A task, its structure, A typical finite state machine, Steps showing the how FSM works. A semaphore, its structure, binary semaphore, mutual exclusion (mutex) semaphore, Synchronization between two tasks and multiple tasks, Single shared-resource-access synchronization, Recursive shared- resource-access synchronization. A message queue, its structure, Message copying and memory use for sending and receiving messages, Sending messages in FIFO or LIFO order, broadcasting messages.			08
Unit III			
Chapter 6: Typical Embedded System: Classification and purposes of embedded system, Characters and Quality attributes of embedded system, Core and Supporting components of embedded system, Embedded firmware			05

 KLE Technological University Creating Value Leveraging Knowledge Earlier known as B. V. B. College of Engineering & Technology	FORM ISO 9001: 2008 – BVBCET School of Electronics	Document #: FMCD2005	Rev: 1.0

Chapter 7: Wired and Wireless Protocols: Bus communication protocol (USB,I2C,SPI), Wireless and mobile system protocol (Bluetooth, 802.11 and its variants, ZigBee), Embedded design cycle-case study-ACVM	05
---	-----------

Text Books

1. Silberschatz ,Galvin and Gagne ,||Operating system concepts||,9th edition, WILEYPublication,2018.
2. Qing Li with Caroline Yao, Real-Time Concepts for Embedded Systems, 1E, Published,2011
3. Shibu K V,||Introductionto Embedded systems||,2nd edition, McGraw Hill Education India Private Limited,2017
4. Raj Kamal,|| Embedded Systems||, Paperback,3rd edition, McGraw-Hill Education, 2017

References

- 1.DhananjayDhamdhere,||Operating Systems a Concept Based Approach||,3rd edition, McGraw-HillEducation,2017

Program: V Semester Bachelor of Engineering (Electronics & Communication Engineering)			Teaching Hours
Course Title: Machine Learning		Course Code: 17EECC307	
L-T-P: 2-0-1	Credits: 3	Contact Hours: 4 Hrs/week	
ISA Marks: 50	ESA Marks: 50	Total Marks: 100	
Teaching Hours: 50Hrs	Examination Duration: 3 Hrs		
Content			
Unit – 1			Hrs
Chapter No. 1. Introduction Introduction what is machine learning? Applications of machine learning, types of machine learning: supervised, unsupervised and reinforcement learning, dataset formats, basic terminologies.			05
Chapter No. 2. Supervised Learning Linear regression, logistic regression linear regression: single and multiple variables, sum of squares error function, the gradient descent algorithm, application, logistic regression, the cost function, classification using logistic regression, one-v/s-all classification using logistic regression, regularization.			10
Unit – 2			

 KLE Technological University Creating Value Leveraging Knowledge Earlier known as B. V. B. College of Engineering & Technology	FORM ISO 9001: 2008 – BVBCET School of Electronics	Document #: FMCD2005	Rev: 1.0
Title: Curriculum structure semester wise Electronics and Communication Engineering			Page 48 of 92 Year: 2017-21

Chapter No. 3. Supervised Learning: Neural Network Introduction to perception learning, implementing simple gates XOR, AND, OR using neural network. Model representation, gradient checking, back propagation algorithm, multi-class classification, application-classifying digits, SVM.	10
Chapter No. 4. Unsupervised Learning: Clustering Introduction, K means clustering, algorithm, cost function, application.	05
Unit – 3	
Chapter No. 5. Unsupervised Learning: Dimensionality reduction Dimensionality reduction, PCA- principal component analysis, applications, clustering data and PCA.	04
Text Book <input type="checkbox"/> <ol style="list-style-type: none"> 1. Tom Mitchell, Machine Learning, 1st edition, McGraw-Hill. , 2017 2. Christopher Bishop, Pattern Recognition and Machine Learning, 1, Springer, 2nd printing 2011 edition References <ol style="list-style-type: none"> 1. Video lectures by : Andrew Ng, Co-founder, Coursera; Adjunct Professor, Stanford University; formerly head of Baidu AI Group/Google Brain https://www.coursera.org/learn/machine-learning# 2. Trevor Hastie, Robert Tibshirani, Jerome Friedman, The Elements of Statistical Learning : Data Mining, Inference and Prediction, 2nd edition, Springer, 9th printing 2017 edition 	

 KLE Technological University Creating Value Leveraging Knowledge Earlier known as B. V. B. College of Engineering & Technology	FORM ISO 9001: 2008 – BVBCET School of Electronics	Document #: FMCD2005	Rev: 1.0
Title: Curriculum structure semester wise Electronics and Communication Engineering		Page 49 of 92 Year: 2017-21	

Program: V Semester Bachelor of Engineering (Electronics & Communication Engineering)		Teaching Hours
Course Title: Communication and Signal Processing Lab		Course Code: 17EECP301
L-T-P: 0-0-1	Credits: 1	Contact Hours: 2 Hrs/week
ISA Marks: 80	ESA Marks: 20	Total Marks: 100
Teaching Hours: 24Hrs	Examination Duration: -	
List of Experiments		
Proof of concept on Discrete ICs		
<ol style="list-style-type: none"> 1. DSBSC modulator and demodulator. 2. Frequency modulator and demodulator 3. Frequency Shift Keying (FSK) modulator and demodulator. 4. Time Division Multiplexing with minimum four channels 		
Mathematical Modeling and Simulation		
<ol style="list-style-type: none"> 1. Design Square Law Modulator and detect the signal using square law and envelope schemes. 2. Design Frequency Modulator and Demodulator and analyze the performance without and with noise. 3. Design, analyze and compare the BER for different digital modulation techniques. 4. Develop a model and simulate BPSK using Costas loop. 		
Implementation on Real Time Hardware		
<ol style="list-style-type: none"> 1. Design and Implement a complete real-time RF transceiver on Advanced Omni Software Radio Transceiver (AOSRT) for Narrow Band Frequency Modulation and Wide band Frequency Modulation and performance analysis. 2. Design and Implement a real-time RF transceiver for audio input using M-array PSK modulation scheme and analyze performance in terms of SNR and BER. 		
Open Ended Experiment		
<ol style="list-style-type: none"> 1. Explore the features of SDR to design an appropriate and robust frequency selective system to eliminate noise present in an audio signal. 		

 KLE Technological University Creating Value Leveraging Knowledge Earlier known as B. V. B. College of Engineering & Technology	FORM ISO 9001: 2008 – BVBCET School of Electronics	Document #: FMCD2005	Rev: 1.0
Title: Curriculum structure semester wise Electronics and Communication Engineering		Page 50 of 92 Year: 2017-21	

Program: V Semester Bachelor of Engineering (Electronics & Communication Engineering)		
CMOS VLSI Circuits Laboratory Experiments		Course Code: 19EECP301
ISA Marks: 80	ESA Marks: 20	Total Marks: 100
Teaching Hours: 25Hrs	Examination Duration: 2 Hrs	Contact Hours: 2Hrs/week
List of Experiments:		
<ol style="list-style-type: none"> 1. Introduction to Cadence EDAtool. 2. Static and Dynamic Characteristic of CMOS Inverter. 3. Layout of CMOS Inverter(DRC,LVS) 4. Static and Dynamic Characteristic of CMOS NAND2 andNOR2. 5. Layout of NAND2, NOR2, XOR2 gates (DRC,LVS). 		
Structured Enquiry		
1. Design a Phase Detector usingD-FF		
Open Ended		
1. Design complex combinational circuits and analyze the performance using Cadencetool.		

Books/References:

1. JohnP.Uyemura,-IntroductiontoVLSICircuits andSystemsII,Wiley, 2006.
2. Neil Weste and K. Eshragian,IIPrinciples of CMOS VLSI Design: A System Perspective,II 2nd edition, Pearson Education (Asia) Pvt. Ltd.,2000.

 KLE Technological University Creating Value Leveraging Knowledge Earlier known as B. V. B. College of Engineering & Technology	FORM ISO 9001: 2008 – BVBCET School of Electronics	Document #: FMCD2005	Rev: 1.0

Program: V Semester Bachelor of Engineering (Electronics & Communication Engineering)		
RTOS Laboratory Experiments		Course Code: 17EECP302
ISA Marks: 80	ESA Marks: - 20	Total Marks: 100
Teaching Hours: 24Hrs	Examination Duration: -	Contact Hours: 2 Hrs/week
List of Experiments: <ol style="list-style-type: none"> 1. Analyze and Demonstrate debugging skills for programs given. 2. Program & demonstrate interfaces I2C-memory to LPC2148Microcontroller. 3. Program & demonstrate interfaces SPI-RTC to LPC2148Microcontroller. 4. Program & demonstrate concept of H/W Interrupts interface to LPC2148Microcontroller. 5. Program & demonstrate concept of TaskScheduling. 6. Program & demonstrate concept of Semaphore. 7. Program & demonstrate concept of Mailbox. 8. Program & demonstrate concept of S/W Interrupts. 9. Program & demonstrate concept of interrupts. 10. Program & demonstrate concept of Inter Task Communication. 		
Reference Books <ol style="list-style-type: none"> 1. -ARMSystem- on-Chip Architecture by Steve Furber, LPE, Second Edition, Addison Wesley; 2000 . 2. -Embedded Systems- Architecture, Programming and Design by Raj Kamal, 3rd edition, TMH, 2017 3. Dr. K. V. K. K. Prasad, -Embedded/Realtime systems: concepts, Design & Programming, published by dreamtech press, 2003. 		
Manual <ol style="list-style-type: none"> 1. LPC2148 datasheet by NXP. 2. LPC2148 board manual by ALS, Bangalore. 		

Laboratory Title: Mini Project	Lab. Code: 17EECW301
Total Hours: 60	Duration of ESA Hours: 3 Hours
ISA Marks: 50	ESA Marks: 50
Guide lines for selection of a project: <ol style="list-style-type: none"> 1. The project needs to encompass the concepts learnt in a subject/s studied in the previous four semesters, so that the student will learn to integrate, the knowledge base acquired to provide a solution to the identified need. 2. Project should be able to exhibit sensing, controlling and actuation sections. 3. The mini project essentially will comprise of two components: 	

 KLE Technological University Creating Value Leveraging Knowledge Earlier known as B. V. B. College of Engineering & Technology	FORM ISO 9001: 2008 – BVBCET School of Electronics	Document #: FMCD2005	Rev: 1.0
Title: Curriculum structure semester wise Electronics and Communication Engineering			Page 52 of 92 Year: 2017-21

- The hardware design
- The graphical user interface (GUI) for application and data analysis with report generation.

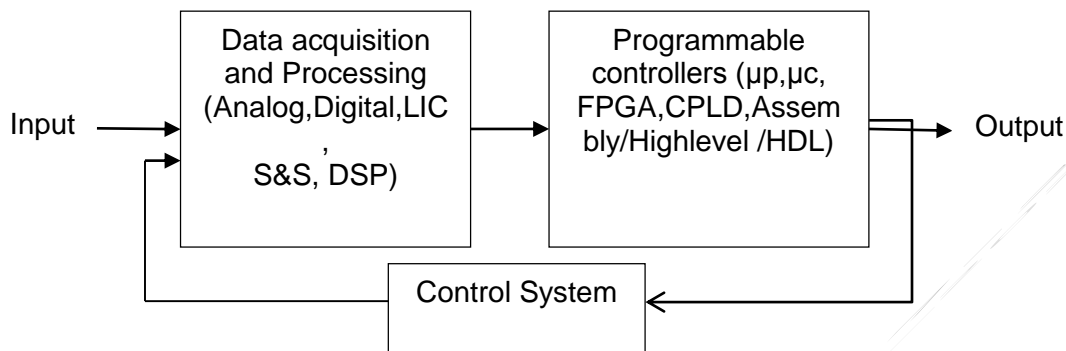

- Student can select a project which leads to a product or model or prototype related to following areas (not limited to these areas).
 - Pulse and digital circuits: simulate the working of one or more circuits
 - Signals and systems: simulate the behavior of a system by considering different signals
 - Analog Electronic: simulate working of different devices
 - Control systems: simulate the behavior of a control system
 - Linear Integrated Circuits: simulate working of one or more circuits
 - Micro-controllers: simulate the ALU/control unit of microcontroller
- Time plan: Effort to do the project should be between 120-150 Hrs per team, which includes self study of an individual member (80-100 Hrs) and team work (40-50hrs).
- Learning overhead should be 20-25% of total project development time.

 KLE Technological University Creating Value Leveraging Knowledge Earlier known as B. V. B. College of Engineering & Technology	FORM ISO 9001: 2008 – BVBCET School of Electronics	Document #: FMCD2005	Rev: 1.0

Program: VI Semester Bachelor of Engineering (Electronics & Communication Engineering)			Teaching Hours
Course Title: Automotive Electronics		Course Code: 17EECC305	
L-T-P: 3-0-0	Credits: 3	Contact Hours: 3Hrs/week	
ISA Marks: 50	ESA Marks: 50	Total Marks: 100	
Teaching Hours: 40 Hrs	Examination Duration: 3 Hrs		
Unit I			
Chapter 1: Introduction: Automotive Systems, Design cycle and Automotive industry overview : Overview of Automotive industry, Vehicle functional domains and their requirements, automotive supply chain, global challenges. Role of technology in Automotive Electronics and interdisciplinary design.. Introduction to modern automotive systems and need for electronics in automobiles and application areas of electronic systems in modern automobiles, Introduction to power train, Automotive transmissions system ,Vehicle braking fundamentals, Steering Control, ,Overview of Hybrid Vehicles, ECU Design Cycle : Types of model development cycles(V and A) , Components of ECU, Examples of ECU on Chassis, Infotainment, Body Electronics and cluster.			07
Chapter 2: Embedded system in Automotive Applications & Automotive safety systems Automotive grade microcontrollers: Architectural attributes relevant to automotive applications, Automotive grade processors ex: Renesas, Quorivva, Infineon. EMS: Engine control functions, Fuel control, Electronic systems in Engines , Development of control algorithm for EMS, Look-up tables and maps, Need of maps, Procedure to generate maps, Fuel maps/tables, Ignition maps/tables, Engine calibration, Torque table, Dynamometer testing Safety Systems in Automobiles: Active and Passive safety systems: ABS, TCS, ESP, Brake assist, Airbag systemsetc.			08
Unit II			
Chapter 3: Automotive Sensors and Actuators Sensor characteristics, Sensor response, Sensor error, Redundancy of sensors in ECUs, Avoiding redundancy, Smart Nodes , Examples of sensors : Accelerometer (knock sensors),wheel speed sensors, Engine speed sensor, Vehicle speed sensor, Throttle position sensor, Temperature sensor, Mass air flow (MAF) rate sensor, Exhaust gas oxygen concentration sensor, Throttle plate angular position sensor, Crankshaft angular position/RPM sensor, Manifold Absolute Pressure (MAP) sensor. Actuators: ENGINE CONTROL ACTUATORS, Solenoid actuator, Exhaust Gas Recirculation Actuator.			08
Chapter 4: Automotive communication protocols : Overview of Automotive communication protocols : CAN, LIN , Flex Ray, MOST			07
Unit III			
Chapter 5:Advanced Driver Assistance Systems (ADAS) and Functional safety standards : Advanced Driver Assistance Systems (ADAS):Examples of assistance applications: Lane Departure Warning, Collision Warning, Automatic Cruise Control, Pedestrian Protection, Headlights Control, Connected Cars technology and trends towards Autonomous vehicles.			05

 KLE Technological University Creating Value Leveraging Knowledge Earlier known as B. V. B. College of Engineering & Technology	FORM ISO 9001: 2008 – BVBCET School of Electronics	Document #: FMCD2005	Rev: 1.0
Title: Curriculum structure semester wise Electronics and Communication Engineering		Page 54 of 92 Year: 2017-21	

Functional Safety: Need for safety standard-ISO 26262, safety concept, safety process for product life cycle, safety by design, validation.

Chapter 6: Diagnostics :
 Fundamentals of Diagnostics, Basic wiring system and Multiplex wiring system, Preliminary checks and adjustments, Self-diagnostic system. Fault finding and corrective measures, Electronic transmission checks and Diagnosis, Diagnostic procedures and sequence, On board and off board diagnostics in Automobiles, OBDII, Concept of DTCs, DLC, MIL, Freeze Frames, History memory, Diagnostic tools, Diagnostic protocols KWP2000 and UDS

05

1. Ribbens, Understanding of Automotive electronics, 8th edition , Elsevier,2017
2. Denton.T , Automobile Electrical and Electronic Systems, 5th edition, Routledge, 2017
3. Denton.T , Advanced automotive fault diagnosis, 4th edition Routledge, 2016

References

1. Ronald K Jurgen, Automotive Electronics Handbook, 2nd Edition, McGraw-Hill,1999
2. James D Halderman, Automotive electricity and Electronics, 5th edition, Pearson, 2016
3. Allan Bonnick, Automotive Computer Controlled Systems Diagnostic Tools and Techniques, Elsevier Science,2001
4. Nicholas Navet , Automotive Embedded System Handbook ,2009

 KLE Technological University Creating Value Leveraging Knowledge Earlier known as B. V. B. College of Engineering & Technology	FORM ISO 9001: 2008 – BVBCET School of Electronics	Document #: FMCD2005	Rev: 1.0
	Title: Curriculum structure semester wise Electronics and Communication Engineering		Page 55 of 92 Year:

Program: VI Semester Bachelor of Engineering (Electronics & Communication Engineering)		Teaching Hours
Course Title: Computer Communication Networks	Course Code: 17EECC306	
L-T-P: 4-0-0	Credits: 4	
ISA Marks:50	ESA Marks: 50	
Teaching Hours: 50Hrs	Examination Duration: 3 Hrs	
Total Marks: 100		
Content		Hrs
Unit - 1		
Chapter No. 1. Computer Networks and the Internet		08 hrs
What is Internet?The Network Edge, the network Core,delay -loss—throughput in packet switched networks. Protocol layers (OSI layers) and their service models,networks under attack.		
Chapter No. 2. Application Layer		12 hrs
Principles of network applications,the web and HTTP,DHCP, file transfer-FTP,electronic mail in the internet,DNS,peer-to-peer applications,socket programming-creating network applications		
Unit - 2		
Chapter No. 3. Transport Layer		10 hrs
Introduction and transport-layer services-relationship between transport and network layers - overview of the transport layer in the internet, multiplexing and de multiplexing, connectionless transport: UDP, principles of reliable data transfer, connection oriented transport TCP, TCP congestion control.		
Chapter No. 4. Network layer		10 hrs
Introduction, virtual circuit and datagram networks, what’s inside router? The Internet protocol (IP): forwarding and addressing in the internet, routing algorithms, routing in the internet, broadcast and multi cast routing.		
Unit - 3		
Chapter No. 5. The link layer: Links, Access networks, and LANs		10 hrs
Introduction to the link layer, error-detection and correction techniques, multiple access links and protocols, switched local area networks, link virtualization: A network as a link layer, data center networking, retrospective: A day in the life of a web page request.		
Text Book		
1. Kurose&Ross,ComputerNetworkingATop-DownApproach,6 th editionPEARSON,2013.		
References		
1. LarryL. Peterson&BruceS.Davie,ComputerNetworks:ASystemsApproach,5 th edition, Elsevier, 2011		
2. Behrouz A. Forouzan, Data Communication and Networking,Paperback, 5 th edition, TMG,2017		

 KLE Technological University Creating Value Leveraging Knowledge Earlier known as B. V. B. College of Engineering & Technology	FORM ISO 9001: 2008 – BVBCET School of Electronics	Document #: FMCD2005	Rev: 1.0
	Title: Curriculum structure semester wise Electronics and Communication Engineering		Page 56 of 92 Year:

Program: VI Semester Bachelor of Engineering (Electronics & Communication Engineering)			Teaching Hours
Course Title: Communication Systems II		Course Code: 21EECC307	
L-T-P: 3-0-0	Credits: 3	Contact Hours: 3 Hrs/week	
ISA Marks: 50	ESA Marks: 50	Total Marks: 100	
Teaching Hours: 42Hrs	Examination Duration: 3 Hrs		
Content			
Unit – I			Hours
Chapter 01. Quantization and Coding techniques: Quantization, PCM, quantization noise and SNR, robust quantization, DPCM, DM, ADM, coding speech at low bit rates, applications, Binary data formats			06 Hrs
Chapter 02. Digital Modulation Techniques : Digital Modulation formats, Coherent binary modulation techniques, Coherent quadrature modulation techniques. Non-coherent binary modulation techniques, Comparison of Binary and Quaternary Modulation techniques. M-ary Modulation Techniques, effect of ISI, Bit versus Symbol error probability, Synchronization and applications			10 Hrs
Unit – II			
Chapter 03. Base band shaping for data transmission: Base-Band Shaping for Data Transmission, Discrete PAM signals, power spectra of discrete PAM signals. ISI, Nyquist's criterion for distortion less base-band binary transmission, correlative coding, eye pattern, base-band M-ary PAM systems, and adaptive equalization for data transmission.			06 Hrs
Chapter 04. Detection and Estimation: Gram-Schmidt Orthogonalization procedure, geometric interpretation of signals, response of bank of correlators to noisy input, Detection of known signals in noise, probability of error, correlation receiver, matched filter receiver, detection of signals with unknown phase in noise, estimation: concept and criteria, maximum likelihood estimation.			08 Hrs
Chapter 05. Introduction to Information Theory: Basics of Information, Discrete communication channels.			02 Hrs
Unit - III			
Chapter 06. Information Theory: Information Theory: Introduction, Measure of information, Average information content of symbols in long independent sequences, Average information content of symbols in long dependent sequences.			08 Hrs

 KLE Technological University Creating Value Leveraging Knowledge Earlier known as B. V. B. College of Engineering & Technology	FORM ISO 9001: 2008 – BVBCET School of Electronics	Document #: FMCD2005	Rev: 1.0
	Title: Curriculum structure semester wise Electronics and Communication Engineering		Page 57 of 92 Year:

Text Book:

1. Simon Haykin, Digital communications, John Wiley, 2006
2. K. Sam Shanmugam, Digital and analog communication systems, John Wiley, 2006

Reference Book:

1. Simon Haykin, An introduction to Analog and Digital Communication, John Wiley, 2003

Program: VI Semester Bachelor of Engineering (Electronics & Communication Engineering)		
Computer Communication Networks Laboratory Experiments(17EECP303)		
ISA Marks: 80	ESA Marks: - 20	Total Marks: 100
Teaching Hours: 24Hrs	Examination Duration:-	Contact Hours: 2 Hrs/week
<p>List of Experiments</p> <ol style="list-style-type: none"> 1. Introduction to Hardware components and Ethernet LAN setup. 2. Introduction to socketprogramming 3. Implementation ofFTP 4. Implementation of error controltechniques. 5. Implementation of flow controlARQs 6. Introduction to Network operatingsystem. 7. Subnetdesign 8. VLANsetup 9. OSPF and RIP configuration and performanceanalysis 10. eBGP and iBGP configuration and performanceanalysis 		
<p>Text Book</p> <ol style="list-style-type: none"> 1. Kurose&Ross,ComputerNetworkingATop-DownApproach,6theditionPEARSON, 2013. 		
<p>References</p> <ol style="list-style-type: none"> 1. Cisco networking academy,https://www.netacad.com/ 2. Juniper networking academy,https://learningportal.juniper.net/ 		

 KLE Technological University Creating Value Leveraging Knowledge Earlier known as B. V. B. College of Engineering & Technology	FORM ISO 9001: 2008 – BVBCET School of Electronics	Document #: FMCD2005	Rev: 1.0
Title: Curriculum structure semester wise Electronics and Communication Engineering			Page 58 of 92 Year:

Program: VI Semester Bachelor of Engineering (Electronics & Communication Engineering)		
Automotive Electronics Laboratory Experiments(17EECP304)		
ISA Marks: 80	ESA Marks: - 20	Total Marks: 100
Teaching Hours: 24Hrs	Examination Duration:-	Contact Hours: 2 Hrs/week
List of Experiments <ol style="list-style-type: none"> 1. Demonstration of cut section modules: Engine, Transmission , Steering, Braking, Suspension - Automobile dept. 2. Electronic engine control system: Injection and Ignition control system Transmission trainer modules 3. Modeling a vehicle motion on a flat surface during hard acceleration, deceleration and steady acceleration. 4. Simulation and modeling of a system and realization on the hardware platform. 5. Modeling Seat belt warning system, and Vehicle speed control based on the gear input. 6. EGAS modeling and simulation using Simulink and realization on the hardware platform. 7. Interior lighting control modeling with state flow. 8. Gear input transmission over CAN bus using ARM Cortex m3 and signal analysis using CANalyzer/BusMaster software. 9. Realize Steer by wire system using model based design. 10. Realize cruise application using model based design 		
Text Books <ol style="list-style-type: none"> 1. Ribbens, Understanding of Automotive electronics, 6th , Elsevier,2003 2. Denton.T , Automobile Electrical and Electronic Systems, 5th edition, Routledge, 2017 		

 KLE Technological University Creating Value Leveraging Knowledge Earlier known as B. V. B. College of Engineering & Technology	FORM ISO 9001: 2008 – BVBCET School of Electronics	Document #: FMCD2005	Rev: 1.0
Title: Curriculum structure semester wise Electronics and Communication Engineering		Page 59 of 92 Year:	

Laboratory Title: Minor Project	Lab. Code: 17EECW302
Total Hours: 70	Duration of Exam: Hours: 2
Total Exam Marks: 50	Total ISA. Marks: 50

Application Areas are,

- Smart City
- Connected Cars
- Home Automation
- Health care
- Smart energy
- Agriculture

Guide lines for selection of a project:

1. The project needs to encompass the concepts learnt in a subject/s studied in the previous five semesters, so that the student will learn to integrate, the knowledge base acquired to provide a solution to the defined problem statement of the minor-projects.
2. Student can select a project which leads to a product or model or prototype.
3. Time plan: Effort to do the project should be between 120-150 Hrs per team, which includes self study of an individual member (80-100 Hrs) and team work (40-50hrs).
4. Learning overhead should be 20-25% of total project development time.

*

Criteria for group formation :

1. 3-4 students in a team.
2. Role of teammates: Team lead and members.

Allocation of Guides and Mentors for the projects:

Every Project batch will be allocated with one faculty.

Details of the project batches:

1. Number of faculty members : 64
2. Number of students: 278

Role of a Guide

The primary responsibility of the guide is to help students to understand the meaning and need of various stages in the implementation of the project. At every stage of the project development, guide should help towards its successful completion as per the predefined standards.

 KLE Technological University Creating Value Leveraging Knowledge Earlier known as B. V. B. College of Engineering & Technology	FORM ISO 9001: 2008 – BVBCET School of Electronics	Document #: FMCD2005	Rev: 1.0
	Title: Curriculum structure semester wise Electronics and Communication Engineering		Page 60 of 92 Year:

How student should carry out a project:

1. Define the problem
2. Specify the requirements
3. Specify the design in the understandable form (Block Diagram, Flowchart, Algorithm, etc)
4. Analyze the design
5. Select appropriate simulation tool and development board for the design.
6. Implement the design
7. Optimize the design and generate the results with optimized design.
8. Result representation and analysis
9. Prepare a document and presentation.

Report Writing

1. The format for report writing should be downloaded from <ftp://10.3.0.3/minorprojects>
2. The report needs to be shown to guide and committee for each review.

Course Title: Analog Circuit Design		Course Code: 17EECE301
L-T-P-SS: 3-0-0-0	Credits: 3	Contact Hours: 3
CIE Marks: 50	SEE Marks: 50	Self-Study : --
Teaching Hours: 40	Examination Duration: 3 hours	Total Marks: 100
UNIT I		
1. Basic MOS Device Physics: General considerations, MOS I/V characteristics, second order effects and MOS device models.		04
2. Current Mirrors: Basic current Mirror, Widlar, Cascode and Wilson Current Mirrors.		04
3. Single Stage Amplifiers: CS, CG, CD, Cascode and Folded Cascode. Frequency response curves		08
UNIT II		
4. Differential Amplifiers: Differential Amplifier, 5 pack differential Amplifier, CMRR, PSRR		05

 KLE Technological University Creating Value Leveraging Knowledge Earlier known as B. V. B. College of Engineering & Technology	FORM ISO 9001: 2008 – BVBCET School of Electronics	Document #: FMCD2005	Rev: 1.0
	Title: Curriculum structure semester wise Electronics and Communication Engineering		Page 61 of 92 Year:

5. Op-Amp: Performance parameters, Two stage (7-pack) Op-amp, Slew rate, PSRR , Noise in Op-amps	06
6. Compensation Technique: Nyquist stability Criterion, Gain and Phase margins, Compensation of Two stage op-amp and Dominant pole compensation technique.	04
UNIT III	
7. Reference Circuits: Current reference, startup circuits, Bandgap reference circuit, Current mode Bandgap reference.	04
8. Comparators: Basic Comparator architecture, non-idealities-offset error, bandwidth consideration, Dynamic comparator,	
Text Books	
1. B Razavi ‘Design of Analog CMOS Integrated Circuits’ First Edition McGraw Hill 2001 2. Phillip. E. Allen, Douglas R. Holberg, “CMOS Analog circuit Design” Oxford University Press, 2002. 3. Baker, Li, Boyce, “CMOS: Circuit Design, Layout and Simulation”, Prentice Hall of India, 2000	
Reference Books	
1. N. Weste and K. Eshraghian, Principles of CMOS VLSI Design, Addison Wesley. 1985. 2. J. Rabaey, Digital Integrated Circuits: A Design Perspective, Prentice Hall India, 1997	

Course Title: Advanced Digital Logic Design		Course code: 17EECE302	
L-T- P: 0-0-3		Credits: 03	Contact Hrs: 04hrs/week
CIE Marks: 100		SEE Marks: 00	Total Marks: 100
Teaching Hrs: 16hrs Lab Hrs: 24 hrs			
Chapter No. 1. Digital Integrated Circuits Challenges in digital design, Design metrics, Cost of Integrated circuits, ASIC , Evolution of SoC ASIC Flow Vs SoC Flow, SoC Design Challenges. Introduction to CMOS Technology, PMOS & NMOS Operation, CMOS Operation principles, Characteristic curves of CMOS, CMOS Inverter and characteristic curves, Delays in inverters, Buffer Design, Power dissipation in CMOS, CMOS Logic, Stick diagrams and Layout diagrams. Setup time, Hold Time, Timing Concepts.			8 hrs
Chapter No. 2. Digital Building Blocks			6 hrs

 KLE Technological University Creating Value Leveraging Knowledge Earlier known as B. V. B. College of Engineering & Technology	FORM ISO 9001: 2008 – BVBCET School of Electronics	Document #: FMCD2005	Rev: 1.0
	Title: Curriculum structure semester wise Electronics and Communication Engineering		Page 62 of 92 Year:

Decoder, encoder, code converters, Priority encoder, multiplexer, demultiplexer, Comparators, Parity check schemes, Multiplexer, De-multiplexer, Pass Transistor Logic, application of multiplexer as a multi-purpose logical element. Asynchronous and synchronous up-down counters, Shift registers. FSM Design, Mealy and Moore Modelling, Adder & Multiplier concepts, Memory Concept	
Chapter No. 3. Logic Design Using Verilog Evolution & importance of HDL, Introduction to Verilog, Levels of Abstraction, Typical Design Flow, Lexical Conventions, Data Types Modules, Nets, Values, Data Types, Comments, arrays in Verilog, Expressions, Operators, Operands, Arrays, memories, Strings , Delays , parameterized designs Procedural blocks, Blocking and Non-Blocking Assignment, looping, flow Control, Task, Function, Synchronization, Event Simulation. Need for Verification, Basic test bench generation and Simulation	10 hrs
Chapter No. 4. Principles of RTL Design Verilog Coding Concepts, Verilog coding guide lines: Combinational, Sequential, FSM. General Guidelines, Synthesizable Verilog Constructs, Sensitivity List, Verilog Events, RTL Design Challenges, Clock Domain Crossing. Verilog modeling of combinational logic and sequential logic	8 hrs
Chapter No. 5. Design and simulation of Architectural building blocks Basic Building blocks design using Verilog HDL: Arithmetic Components – Adder, Subtractor, and Multiplier design, Data Integrity – Parity Generation circuits, Control logic – Arbitration, FSM Design – overlapping and non-overlapping Mealy and Moore state machine design	8 hrs
Reference Books: <ol style="list-style-type: none"> 1. Digital Design by Morris Mano M, 4th Edition. 2. Verilog HDL: A Guide to Digital Design and Synthesis by Samir Palnitkar, 2nd Edition. 3. Principles of VLSI RTL Design: A Practical Guide by Sapan Garg, 2011. Tools: Questa Sim, NC Verilog, NC Sim, CVER + GTKWave, VCSMX, Modelsim for Verilog	

Course Title: Internet of Things	Course Code: 17EECE307
Total Contact Hours: 3	Duration of ESA: 3 Hours
ISA Marks: 50	ESA Marks: 50

Content	Hrs
Unit - 1	
Chapter No. 1. Introduction to IoT	6 hrs

 KLE Technological University Creating Value Leveraging Knowledge Earlier known as B. V. B. College of Engineering & Technology	FORM ISO 9001: 2008 – BVBCET School of Electronics	Document #: FMCD2005	Rev: 1.0
Title: Curriculum structure semester wise Electronics and Communication Engineering		Page 63 of 92 Year:	

Defining IoT, Characteristics of IoT, What is the IoT and why is it important? Elements of an IoT ecosystem. Technology and business drivers. IoT applications, trends and implications. Physical design of IoT, Logical design of IoT, Functional blocks of IoT, Communication models & APIs	
Chapter No. 2. IoT Architecture: State of the Art History of IoT, M2M – Machine to Machine, Web of Things, IoT protocols Applications: Remote Monitoring & Sensing, Remote Controlling, Performance Analysis.	4 hrs
Unit - 2	
Chapter No. 3. IoT Communication : The Layering concepts , IoT Communication Pattern, IoT protocol Architecture, The 6LoWPAN, Security aspects in IoT	4 hrs
Chapter No. 4. IoT Application Development: Application Protocols MQTT, REST/HTTP, CoAP, MySQL	6 hrs
Unit - 3	
Chapter No. 5. Case Study & advanced IoT Applications: IoT applications in home, infrastructures, buildings, security, Industries, Home appliances, other IoT electronic equipment's. Use of Big Data and Visualization in IoT, Industry 4.0 concepts.	6 hrs

<u>Hands-on Lab</u> <u>Arduino, Android and AWS based Experiments</u> <ol style="list-style-type: none"> 1. AWS Setup and instance creation. 2. Controlling LEDs blinking pattern through UART/WiFi 3. Simple photocell to measure the ambient light level 4. Controlling LEDs blinking pattern through PHP web server. 5. Temperature measurement through ADC and WiFi 6. Controlling and interacting with basic actuators (relay). 7. Android Application development. 8. Controlling of Arduino embedded system using Android App. 9. Motor Speed control using Embedded board and NodeMCU <u>Lua Programming Based Experiments</u>

 KLE Technological University Creating Value Leveraging Knowledge Earlier known as B. V. B. College of Engineering & Technology	FORM ISO 9001: 2008 – BVBCET School of Electronics	Document #: FMCD2005	Rev: 1.0
			Title: Curriculum structure semester wise Electronics and Communication Engineering

1. Introduction to Lua programming
 2. Controlling inbuilt LED of ESP8266
 3. Controlling Motion Sensor using NodeMCU module.
 4. Using ESP8266 as Webserver
 - a. Understanding HTML Tags.
 - b. Understanding Request.
 - c. Reading Parameter Values.
 - d. Controlling LED.
 5. ThingSpeak Cloud - Data Visualization
 - a. Working with Temperature & Humidity Sensor
 - b. Working with ThingSpeak Cloud
 - c. Posting & Analyzing Sensor Data on ThingSpeak Cloud
 - d. ThingSpeak Cloud - Mobile App
- Working with MQTT/HTTP**
1. Introduction to Cloud MQTT
 2. MQTT - Wireless Communication between two ESP boards
 3. Controlling LED using voice commands - HTTP to MQTT Bridge

Course Title: Information Theory and Coding	Course Code: 21EECE308
Total Contact Hours: 40	Duration of ESA Hours: 3 hours
ESA Marks: 50	ISA Marks: 50

Content	Hrs
Unit - 1	
Chapter 01. Review of information theory: Basics of Information, Measure of information, Entropy.	02 Hrs
Chapter 02. Discrete Channels: Discrete memory less Channels, Mutual information, Channel Capacity, Differential entropy and mutual information for continuous ensembles, Channel capacity Theorem.	08 Hrs
Chapter 03. Source Coding: Encoding of the source output, Shannon’s encoding algorithm. Source coding theorem, Binary, ternary and quaternary Huffman coding, Construction of instantaneous codes.	08 Hrs
Unit - 2	
Chapter 04. Introduction to Error Control Coding: Introduction, Types of errors,	06 Hrs

 KLE Technological University Creating Value Leveraging Knowledge Earlier known as B. V. B. College of Engineering & Technology	FORM ISO 9001: 2008 – BVBCET School of Electronics	Document #: FMCD2005	Rev: 1.0
	Title: Curriculum structure semester wise Electronics and Communication Engineering		Page 65 of 92 Year:

examples, Types of codes Linear Block Codes: Matrix description, Error detection and correction, Standard arrays and table look up for decoding, Generation of Hamming Codes.	
Chapter 05. Binary Cycle Codes: Algebraic structures of cyclic codes, Encoding using an (n-k) bit shift register, Systematic codes, non systematic codes , Error detection and error correction (Syndrome calculation) circuits.	05 Hrs
Chapter 06. Convolutional codes: Convolution Codes, Time domain approach. Transform domain approach. Systematic Convolution codes, Maximum Likelihood Decoding of Convolutional codes.	05 Hrs
Unit - 3	
Chapter 07. Coding for burst error correction and other types of codes: Burst and random error correcting codes, cyclic codes and convolutional codes for bursts error correction, Reed soloman codes, Cyclic redundancy codes, Golay codes, Shortened cyclic codes, Burst error correcting codes. Burst and Random Error correcting codes.	08 Hrs

Text Book (List of books as mentioned in the approved syllabus)

1. K. Sam Shanmugam, Digital and analog communication systems, John Wiley, 1996
2. Simon Haykin, Digital communication, John Wiley, 2003

References

1. Ranjan Bose, ITC and Cryptography, TMH(reprint 2007), 2002
2. Glover and Grant, Digital Communications , 2, Pearson, 2008
3. D Ganesh Rao, K N Haribhat, Digital Communications, Sanguine, 2009

Course Title: Embedded Intelligent Systems		Course Code: 17EECE310
L-T-P: 0-0-3	Credits: 3	Contact Hrs: 6hrs/week
ISA Marks: 80	ESA Marks: 20	Total Marks: 100
Teaching Hrs: 60	Exam Duration: 3 hrs	

Unit - I		
1	Basics of embedded systems Linux Application Programming, System V IPC, . Linux Kernel Internals and Architecture , Kernel Core , Linux Device Driver Programming, Interrupts & Timers , Sample shell script, application program, driver source build and execute	10 hrs
2	Heterogeneous computing Basics of heterogeneous computing with various hardware architectures designed for specific type of tasks, Advanced heterogeneous computing with a. Introduction to Parallel	12 hrs

 KLE Technological University Creating Value Leveraging Knowledge Earlier known as B. V. B. College of Engineering & Technology	FORM	Document #: FMCD2005	Rev: 1.0
	ISO 9001: 2008 – BVBCET School of Electronics		
Title: Curriculum structure semester wise Electronics and Communication Engineering			Page 66 of 92
			Year:

	programming b.GPU programming (OpenCL). Open standards for heterogeneous computing (Openvx) , Basic OpenCL examples - Coding, compilation and execution	
Unit - II		
3	ML Frameworks with the target device Caffe, tensorflow, TF Lite machine learning frameworks & architecture ,Model parsing, feature support and flexibility ,Supported layers , advantages and disadvantages with each of these frameworks, Android NN architecture overview , Full stack compilation and execution on embedded device	16 hrs
4	Model Development and Optimization Significance of on device AI ,Quantization , pruning, weight sharing, Distillation ,Various pre-trained networks and design considerations to choose a particular pre-trained model ,Federated Learning , Flexible Inferencing	8 hrs
Unit - III		
5	Android Anatomy Android Architecture ,Linux Kernel , Binder , HAL Native Libraries , Android Runtime, Dalvik Application framework , Applications, IPC	8 hrs
Text Books		
<ol style="list-style-type: none"> Linux System Programming , by Robert Love , Copyright © 2007 O'Reilly Media Heterogeneous Computing with OpenCL, 2nd Edition by Dana Schaa, Perhaad Mistry, David R. Kaeli, Lee Howes, Benedict Gaster , Publisher: Morgan Kaufmann 		
Reference Books:		
<ol style="list-style-type: none"> Deep Learning , MIT Press book ,Goodfellow, Bengio, and Courville's Beginning Android , by Wei-Meng Lee , Publisher: Wrox , O'Reilly Media 		

Scheme for End Semester Assessment (ESA)

UNIT	Experiments to be set of 10 Marks Each	Chapter Numbers	Instructions
I	Project Examination	1,2,3,4,5	Project implementation and demonstration 20 marks

Course Code: 20EECE340	Course Title: Multicore Architecture and Programming	
L-T-P : 2-0-1	Credits: 3	Contact Hrs: 4Hr/week
ISA Marks:50	ESA Marks: 50	Total Marks: 100

 KLE Technological University Creating Value Leveraging Knowledge Earlier known as B. V. B. College of Engineering & Technology	FORM ISO 9001: 2008 – BVBCET School of Electronics	Document #: FMCD2005	Rev: 1.0
	Title: Curriculum structure semester wise Electronics and Communication Engineering		Page 67 of 92 Year:

Teaching Hrs: 52		Exam Duration: 3
------------------	--	------------------

Content	Hrs
Unit - 1	
Chapter No. 1: Introduction to Multicore Drivers for Multicore Architectures: Low power, Performance/Throughput and need for memory bandwidth – Limits of single core computing – Moore’s law - Limits to Instruction Level Parallelism (ILP) – Power and heat dissipation issue – Increased amount of data to process – Evolution from traditional System-On-Chip (SoC) to MPSoCs (Multi processor System-On-Chips) - Need for Multicore controllers in Automotive domain	4hrs
Chapter No. 2: Multicore Architecture Dependent Multicore software and hardware architectures –Multicore hardware architecture overview: Heterogeneous and Homogenous Multicore hardware – Communication between hardware processing elements: Point-to-point connections, Shared buses, On-chip cross bar, Network-On-Chip (NoC) - Memory access in Multicore architectures: Symmetric Multi-Processing (SMP), Asymmetric Multi processing aka NUMA (Add pros and cons)– Multicore architecture specific to applications - Example Multicore hardware used in Automotive – Infineon Tricore series, ST devices	12hrs
Unit - 2	
Chapter No. 3: Scheduling concepts and OS aspects What is Scheduling? – Static and Dynamic Scheduling - Scheduling algorithms: Rate Monotonic Scheduling (RMS), Fixed priority preemptive scheduling, Round robin scheduling, Earliest deadline first, First come First serve – Process and threads - What is pre-emption? Why is it needed?- Types of Multicore Scheduling: Global, Semi-partitioned and Partitioned –OS for General purpose and Real time systems - Scheduling in Single core vs Scheduling in Multicore – Timing Jitter	10 hrs
Chapter No. 4:Concurrency and Parallelism Amdahl’s law – Need for Parallelism – Concurrency Fundamentals – Data parallelism, Functional Parallelism, loop Parallelism – Dependencies – Producer consumer`— Need for Synchronization, Loop dependencies–Shared resources – Caching aspects - Problems with no synchronization - Synchronization primitives – Semaphore, Mutex, spinlocks, Test and Set, Compare and swap–Synchronization related issues and how to avoid them: Data races, Livelocks, Deadlock, Non-atomic operations –	10hrs
Unit - 3	

 KLE Technological University Creating Value Leveraging Knowledge Earlier known as B. V. B. College of Engineering & Technology	FORM ISO 9001: 2008 – BVBCET School of Electronics	Document #: FMCD2005	Rev: 1.0
			Title: Curriculum structure semester wise Electronics and Communication Engineering

Chapter 5: Advanced Multicore topics – Introduction/Overview Multicore timing analysis - Timing simulation: Why it is needed? – WCET (Worst Case Execution Time) analysis – Schedulability analysis – Additional challenges in Multicore - Tools used in automotive: Timing architect, ChronSIM, Sym TA/S- Deterministic behavior – Logical Execution Time (LET)	4hrs
--	------

References:

Highly Recommended: Real world Multicore embedded systems – Bryon Moyer
 Highly Recommended for Embedded system and Real Time basics -Programming *Embedded Systems* with C and GNU Development Tools – Michael Barr

References in the internet for Multicore timing analysis:

Why is timing analysis important: <http://embedded.cs.uni-saarland.de/publications/EnablingCompositionalityRTNS2016.pdf>

Multicore timing simulation solutions:

<https://www.vector.com/int/en/events/global-de-en/webinars/2020/timing-analysis-for-multicore-ecus/>
<https://www.rapitasystems.com/multicore-timing>
<https://www.inchron.com/tool-suite/chronsim/>
<https://www.absint.com/ait/symtas.htm>
<https://www.danlawinc.com/wp-content/uploads/MC-BR-006-Multicore-Timing-Analysis-Solution-For-Aerospace-v3.pdf>

Logical Execution Time (LET)

<https://ieeexplore.ieee.org/document/5577967>

Course Code: 18EECE421	Course Title: OOPS using C++	
L-T-P: 2-0-1	Credits: 3	Contact Hrs: 42
ISA: Marks: 80	ESA Marks: 20	Total Marks: 100
Teaching Hrs: 42		Exam Duration:

Content	Hrs
Unit - 1	
Chapter 1: Fundamental concepts of object oriented programming: Introduction to object oriented programming, Programming Basics (keywords, identifiers, variables, operators, classes, objects), Arrays and Strings Functions/ methods (parameter passing techniques),	04 hrs

 KLE Technological University Creating Value Leveraging Knowledge Earlier known as B. V. B. College of Engineering & Technology	FORM ISO 9001: 2008 – BVBCET School of Electronics	Document #: FMCD2005	Rev: 1.0
			Title: Curriculum structure semester wise Electronics and Communication Engineering

Chapter 2: OOPs Concepts: Overview of OOPs Principles, Introduction to classes & objects ,Creation & destruction of objects, Data Members, Member Functions , Constructor & Destructor , Static class member, Friend class and functions, Namespace	08hrs
Unit - 2	
Chapter 3: Inheritance: Introduction and benefits, Abstract class, Aggregation: classes within classes Access Specifier, Base and Derived class Constructors, Types of Inheritance. Function overriding	8 hrs
Chapter 4: Polymorphism: Virtual functions, Friend functions, static functions, this pointer	6 hrs
Unit - 3	
Chapter 5: Exception Handling: Introduction to Exception, Benefits of Exception handling, Try and catch block, Throw statement, Pre-defined exceptions in C++,Writing custom Exception class	8 hrs
Chapter 6: I/O Streams: C++ Class Hierarchy, File Stream, Text File Handling, Binary File Handling Error handling during file operations, Overloading << and >> operators	6 hrs

Books/References:

Text Book

1. Robert Lafore, "Object oriented programming in C++", 4th Edition, Pearson education, 2009.

References

1. Lippman S B, Lajorie J, Moo B E, C++ Primer, 5ed, Addison Wesley, 2013.
2. Herbert Schildt: The Complete Reference C++, 4th Edition, Tata McGraw Hill

 KLE Technological University Creating Value Leveraging Knowledge Earlier known as B. V. B. College of Engineering & Technology	FORM ISO 9001: 2008 – BVBCET School of Electronics	Document #: FMCD2005	Rev: 1.0
	Title: Curriculum structure semester wise Electronics and Communication Engineering		Page 70 of 92 Year:

**Batch 2018-22
Semester: VII**

No	Code	Course	Category	L-T-P	Credits	Contact Hours	ISA	ESA	Total	Exam Duration
1	18EECC401	PC16: Wireless & Mobile Communication	PSC	3-0-0	3	3	50	50	100	3 hours
2	18EECE	PSE Elective 1	PSE	3-0-0	3	3	50	50	100	3 hours
3	18EECE	PSE Elective 2	PSE	3-0-0	3	3	50	50	100	3 hours
4	18EECE	PSE Elective 3	PSE	3-0-0	3	3	50	50	100	3 hours
6	18EECE	PSE Elective 4	PSE	3-0-0	3	3	50	50	100	3 hours
	20EECW401	P3: Senior Design Project	PW	0-0-6	6	12	50	50	100	3 hours
7	15EHSC402	CIPE	M	2-0-0		2	50	50	100	3 hours
TOTAL				15-0-6	21	29	350	350	700	

ISA: In Semester Assessment **ESA:** End Semester Assessment **L:** Lecture **T:** Tutorials **P:** Practical

HS (Humanities) = H; B(Basic Science) = B; ES(Engineering Science) = F; PC (Program Core) = C; EC(Any Elective) = E; PW(Project Work) = W; Research = R; Internship= I; Seminar = S; Colloquium = V; Self-study = Y; Special topic= T; Apprenticeship = A; Laboratory / Practical = P; Field Work = D; and Non-credit course = N.

Semester: VII (2018-22 Batch)

No	Code	Course: PSE: Elective	Category	L-T-P	Credits	Contact Hours	ESA	ISA	Total	Exam Duration
1.	19EECE416	Biosensor	PSE	0-0-3	3	3	-	100	100	3Hours
2.	18EECE418	Advanced Digital Logic Verification		0-0-3		6	-	100		
3.	18EECE410	Multimedia Communication		3-0-0		3	50	50		



			0					
4.	18EECE419	Physical Design- Analog	0- 0- 3		6	-	100	
5.	18EECE409	Design and Analysis of Algorithm	0- 0- 3		3	50	50	
6.	18EECE420	CMOS ASIC Design	0- 0- 3		6	-	100	
7.	18EECE405	Embedded Linux	0- 0- 3		3	50	50	
8.	18EECE411	Microwave & Antennas	3- 0- 0		3	50	50	
9.	20EECE406	AUTOSAR	3- 0- 0		3	50	50	
10.	18EECE415	Cryptography & Network Security	3- 0- 0		3	50	50	
11.	19EECE403	Testing & Characterization	0- 0- 3		3	-	100	
12.	21EECE421	RF VLSI (New)	3- 0- 0		3	50	50	
13.	21EECE422	Speech Processing(New)	3- 0- 0		3	50	50	
14.	21EECE423	CAD for VLSI(New)	3- 0- 0		3	50	50	
15.	21EECE424	System on Chip Design(New)	3- 0- 0		3	50	50	
16.	21EECE425	Computer Graphics	0- 0- 3		3	-	100	

 KLE Technological University Creating Value Leveraging Knowledge Earlier known as B. V. B. College of Engineering & Technology	FORM ISO 9001: 2008 – BVBCET School of Electronics	Document #: FMCD2005	Rev: 1.0
	Title: Curriculum structure semester wise Electronics and Communication Engineering		Page 72 of 92 Year:

No	Code	Course	Category	L-T-P	Intern-ship	Credits	Contact Hours	ISA	ESA	Total	Exam Duratio
1	18EECE	PSE Elective 5	PSE	3-0-0	6-0-0	3	3	50	50	100	3 hours
2	18EECE	Open Elective 1	OE	3-0-0		3	3	50	50	100	3 hours
3	20EECW402	Project Work	PRJ	0-0-11		11	22	50	50	100	3 hours
TOTAL				6-0-11		17	28	150	150	300	

Internship- Training: 18EECI493 – 0-0-6, ISA: 80 ESA: 20
Internship- Project: 20EECW494-- 0-0-11, ISA: 50 ESA: 50

ISA: In Semester Assessment **ESA:** End Semester Assessment **L:** Lecture **T:** Tutorials **P:** Practical

HS (Humanities) = H; B(Basic Science) = B; ES(Engineering Science) = F; PC (Program Core) = C; EC(Any Elective) = E; PW(Project Work) = W; Research = R; Internship= I; Seminar = S; Colloquium = V; Self-study = Y; Special topic= T; Apprenticeship = A; Laboratory / Practical = P;Field Work = D; and Non-credit course = N.

Program: VII Semester Bachelor of Engineering (Electronics & Communication Engineering)		
Course Code: 18EECC401	Course Title: Wireless & Mobile Communication	
L-T-P-SS: 3-0-0-0	Credits: 3	Contact Hrs: 40
CIE Marks: 50	SEE Marks: 50	Total Marks: 100
Teaching Hrs: 40		Exam Duration: 3 hrs

Content	Hrs
Unit - 1	
Chapter 01 Radio Propagation Free space propagation model, Relating power to electric field., Relation, ground reflection, scattering, Practical link budget design using path loss model, Outdoor propagation models, Signal penetration into buildings, Ray tracking and site specific modeling, Small scale Multipath measurements,	16

 KLE Technological University Creating Value Leveraging Knowledge Earlier known as B. V. B. College of Engineering & Technology	FORM ISO 9001: 2008 – BVBCET School of Electronics	Document #: FMCD2005	Rev: 1.0
	Title: Curriculum structure semester wise Electronics and Communication Engineering		Page 73 of 92 Year:

Parameters of mobile Multipath channels, Types of small scale fading.	
Unit - 2	
Chapter 02 Diversity techniques Concept of Diversity branch and signal paths, Combining and switching methods, C/N, C/I performance improvements, RAKE receiver.	4
Chapter 03 Cellular concept Frequency reuse, Channel assignment strategies, Handoff strategies, Interference and system capacity, Trucking and grade of service, Improving coverage, Capacity in cellular systems, FDMA, TDMA, Pseudo noise sequences, notion of spread spectrum, processing gain and Jamming margin, direct sequence spread spectrum, frequency hop spread spectrum, Spread spectrum multiple access, SDMA packet radio. Capacity of cellular systems.	12
Unit - 3	
Chapter 04 Personal Mobile satellite Communications Integration of GEO, LEO satellite, MEO satellite, Terrestrial mobile systems and Personal satellite communication programs.	4
Chapter 05 CDMA system implementation IS-95 system architecture, Soft handoff, Power control in IS-95 CDMA, CDMA 2000 system.	4

Text Book (List of books as mentioned in the approved syllabus)

1. T.S. Rapport, Wireless Communication, 2, Pearson Education, 2002

References

1. Kamil O Feher, Wireless digital communications: Modulation and spread spectrum Techniques, Prentice Hall of India, 2004
2. Vijay K Garg, IS_95 CDMA and cdma 2000, Pearson publication pvt. Ltd, 2004
3. Xiaodong Wang and Vincent Poor, wireless Communicating system: Advanced Techniques for signal Reception, Pearson publication pvt. Ltd, 2004

		Teaching Hours	
Course Title: Multimedia Communication			
Course Code: 18EECE410			
L-T-P-SS: 2-0-1-0	Credits: 3		Contact Hours: 3 Hrs/week
CIE Marks: 50	SEE Marks: 50		Total Marks: 100
Teaching Hours: 42Hrs	Examination Duration: 3 Hrs		
Unit I			
Chapter 1: Introduction to Multimedia: Multimedia and Hyper media, WWW, overview of multimedia software tools.		02Hrs	
Chapter 2: Graphics and Image representation: Graphics / Image data types, Popular file formats.		02Hrs	
Chapter 3: Fundamental concepts in video: Types of video signals, analog video, digital video.		06Hrs	
Chapter 4: Basics of digital audio: Digitization of sound, MIDI, Quantization and transmission of audio.		05Hrs	

 KLE Technological University Creating Value Leveraging Knowledge Earlier known as B. V. B. College of Engineering & Technology	FORM ISO 9001: 2008 – BVBCET School of Electronics	Document #: FMCD2005	Rev: 1.0
Title: Curriculum structure semester wise Electronics and Communication Engineering			Page 74 of 92 Year:

<p style="text-align: center;">Unit II</p> <p>Chapter 4: Lossless compression algorithms: Introduction, run-length coding, variable length coding, dictionary based coding, arithmetic coding, lossless image compression.</p> <p>Chapter 5: Lossy compression algorithms: Introduction, distortion measures, quantization, transform coding, wavelet based coding, wavelet packets, embedded zero tree of wavelet coefficients.</p> <p>Chapter 6: Image compression standards: The JPEG standard, The JPEG2000 standard, The JPEG-LS standard, Bi level image compression standard.</p>	<p style="text-align: center;">05Hrs</p> <p style="text-align: center;">06Hrs</p> <p style="text-align: center;">06Hrs</p>
<p style="text-align: center;">Unit III</p> <p>Chapter 7: Basics video compression techniques: Overview, video compression based on motion compensation, H.261</p> <p>Chapter 8: Overview of MPEG-1, 2 4 and 7.</p>	<p style="text-align: center;">08Hrs</p> <p style="text-align: center;">02Hrs</p>
<p>Text Books</p> <p>1. Ze-Nian Li & Mark S Drew, “Fundamentals of multimedia”, Pearson Education, 2004.</p> <p>References</p> <ol style="list-style-type: none"> Ralf Steinmetz & Kalra Nahrstedt , “Multimedia: Computing, Communication & Applications”, Pearson Education, 2004 K R Rao, Zoran S Bojkovic, Dragord A Milovanvic, Pearson education, “Multimedia communication systems: Techniques, Standards, & Networks”,. Second Indian reprint, 2004. 	

 KLE Technological University Creating Value Leveraging Knowledge Earlier known as B. V. B. College of Engineering & Technology	FORM ISO 9001: 2008 – BVBCET School of Electronics	Document #: FMCD2005	Rev: 1.0
	Title: Curriculum structure semester wise Electronics and Communication Engineering		Page 75 of 92 Year:

Course Code: 18EECE403		Course Title: MEMS	
L-T-P: 5	Microsystems Fabrication Processes: Electroplating, Lithography, Ion Implantation, Diffusion, Oxidation, Chemical Vapor Deposition (CVD), Physical Vapor Deposition (PVD), Etching.	Exam Duration: 40	
CIE Marks: 50	SEE Marks: 50	Total Marks: 100	05
6	Micro-manufacturing: Bulk Micro-manufacturing, Surface Micromachining, The LIGA Process.	Exam Duration: 3 hrs	05
Teaching Hrs: 40			
Text Book:			Hrs
MEMS and Microsystems – Design and Manufacture”, Ural-Ran Hsu, TMH Edition 2002.			
References:			
"Microsystem Design of MEMS and Microsystems", Lower Academic Publishers, 2001. "Foundations of MEMS", Chens-Liu, Pearson Edition 2012. "RF MEMS: Theory, Design and Technology", Gabriel M. Rebetz, John Wiley & Sons Publication, 2003. "Microspace, Design and Technology", Industrial Products, Consumer Products and Telecommunications.			05
2	Working principles of Microsystems Micro-sensors: Acoustic wave sensor, Biomedical Sensors and Biosensors, Chemical Sensors Optical Sensors, Pressure Sensors, Thermal Sensors. Micro-actuation: Actuation Using Thermal Forces, Shape Memory Alloys (SMA), Piezoelectric Crystals and Electrostatic Forces. Applications of Micro-actuators: Micro-grippers, Micro-motors, Micro-valves, Micro-pumps. Micro-accelerometers, Micro-fluidics, Numerical Problems.		10
Unit II			
3	Scaling laws in miniaturization: Introduction to scaling, Scaling in Geometry, Rigid-Body Dynamics, Electrostatic Forces, Electromagnetic Forces, Electricity, Fluid Mechanics, Heat Transfer, Numerical problems.		10
4	Materials for MEMS and Microsystem: Substrate and Wafers, Active Substrate Materials, Silicon as Substrate Material, Silicon Compounds, Silicon Piezo resistors, Gallium Arsenide, Quartz, Piezoelectric Crystals, Polymers, Packaging Materials.		05

Course Title: Physical Design-Analog		Course code: 18EECE419	
L-T- P: 0-0-3		Credits: 03	Contact Hrs: 06hrs/week
CIE Marks: 100		SEE Marks: 00	Total Marks: 100
Teaching Hrs: 16hrs			
Lab Hrs: 24 hrs			
Chapter No 1. Standard cell Layout creation Layout Practice Sessions (DRC/LVS Dirty layout), Understanding verification errors, Error debugging skills, Hands on experience of using layout editor, Quality of the layout, Half DRC rules, Mega module creation.			8 hrs
Chapter No 2. Analog layout Importance of performance in Analog layout, Importance of floor planning and placement, Attributes			8 hrs

 KLE Technological University Creating Value Leveraging Knowledge Earlier known as B. V. B. College of Engineering & Technology	FORM ISO 9001: 2008 – BVBCET School of Electronics	Document #: FMCD2005	Rev: 1.0
			Title: Curriculum structure semester wise Electronics and Communication Engineering

need to be taken care during routing stage, Introduction to DRC, LVS, Density and RCX.	
Chapter No 3. Matching and Guard rings, Matching: Introduction to mismatch concepts, Causes for mismatch, Types of mismatch, Rules for matching, Activities. Guard ring : What is guard ring, Usage of guard ring	6 hrs
Chapter No 4. Reliability issues Introduction to failure mechanism, Causes of reliability issues, Process enhancement techniques and Layout considerations to reduce reliability issues	8 hrs
Chapter No 5. Physical design of amplifier and buffer Applying the studied concepts and doing layout, Prioritising the constraints given, Quality checks, Buddy reviews and implementations, Documentation	10 hrs
Reference: The Art of Analog Layout – Alan Hastings CMOS IC layout – Dan Clieen IC Layout Basics – Chris saint and Judy saint	

		Teaching Hours
Course Title: Digital Image Processing	Course Code: 18EECE414	
L-T-P-SS: 2-0-1-0	Credits: 3	
CIE Marks: 50	SEE Marks: 50	
Teaching Hours: 42Hrs	Examination Duration: 3 Hrs	Total Marks: 100

 KLE Technological University Creating Value Leveraging Knowledge Earlier known as B. V. B. College of Engineering & Technology	FORM ISO 9001: 2008 – BVBCET School of Electronics	Document #: FMCD2005	Rev: 1.0
	Title: Curriculum structure semester wise Electronics and Communication Engineering		Page 77 of 92 Year:

Unit I	
Chapter 1: Introduction 2D systems, mathematical preliminaries- FT, Z-transform, Optical and Modulation transfer functions (OTF and MTF).	04Hrs
Chapter 2: Image perception Light, luminance, brightness, contrast, MTF of the visual system, visibility function, monochrome vision models, Image fidelity criteria, colour representation, colour models.	04Hrs
Chapter 3: Image sampling and quantization 2D sampling theory, limitations in sampling and reconstruction, quantization, optimal quantizer, compandor and visual quantization.	07Hrs
Unit II	
Chapter 4: Image transforms 2D orthogonal and unitary transforms, DFT, DCT, DST, Hadamard, Harr, Slant, KLT transforms.	10Hrs
Chapter 5: Image enhancement Histograms modeling, spatial operations, transform operations, multispectral image enhancement, color image enhancement.	07Hrs
Unit III	
Chapter 6: Image filtering and restoration Image observation models, Inverse and wiener filtering, fourier domain filters. Smoothing splines and interpolation. SVD and iterative methods. Maximum entropy restoration, Bayesian methods, co-ordinate transformation and geometric corrections. Blind deconvolution.	10Hrs
Text Books 1. A.K. Jain, "Fundamentals of Digital Image Processing", Pearson Education (Asia) Pvt. Ltd	
References 1. Rafael C. Gonzalez, Richard E. Woods, "Digital Image Processing", Pearson Education (Asia) Pvt. Ltd 2. Rafael C. Gonzalez, Richard E. Woods and Steven L Edidins. "Digital Image Processing Using Matlab", Pearson Education (Asia) Pvt. Ltd	

Course Code: 18EECE415	Course Title: Cryptography and Network Security	
L-T-P-SS: 3-0-0-0	Credits: 3	Contact Hrs: 42
CIE Marks: 50	SEE Marks: 50	Total Marks: 100

 KLE Technological University Creating Value Leveraging Knowledge Earlier known as B. V. B. College of Engineering & Technology	FORM ISO 9001: 2008 – BVBCET School of Electronics	Document #: FMCD2005	Rev: 1.0
	Title: Curriculum structure semester wise Electronics and Communication Engineering		Page 78 of 92 Year:

Teaching Hrs: 42		Exam Duration: 3 hrs
------------------	--	----------------------

Content	Hrs
Unit - 1	
Chapter No. 1. Overview Introduction, Services, Mechanisms and attacks of OSI architecture, Model	2 hrs
Chapter No. 2: Introduction to Finite Fields Groups, Rings and fields. Modular Arithmetic, Euclid’s Algorithm, Extended Euclid’s algorithm, Finite fields of the form GF (p), Finite fields of the form GF(2n) , Polynomial arithmetic, Euler’s and Fermat’s theorem, Chinese remainder theorem	4 hrs
Chapter No. 3: Classical Encryption techniques Symmetric cipher model, substitution technique, Transposition Techniques	5 hrs
Chapter No. 4: Block Ciphers and DES Design and principles of Block Ciphers,DES, Strength of DES, Block Cipher Modes of Operation	5 hrs
Unit - 2	
Chapter No. 5: Advanced Encryption Standards Evaluation Criterion of AES, AES Encryption and AES Decryption	4 hrs
Chapter No. 6: Public Key Cryptography and RSA: Design and principles, Concept of confidentiality and Authentication, RSA algorithm, Other Public Key Crypto Systems, Key Management, Diffie Hellman Key Exchange, Elliptic curve Cryptography	6 hrs
Chapter No. 7: Message Authentication and Hash Functions: Message Authentication codes, Hash functions, Security of Hash and MAC functions	3 hrs
Chapter No. 8: Digital Signature, Authentication and Hash Functions Authentication Protocols, Digital signature Standard, DSS Algorithm	3 hrs
Unit - 3	
Chapter No. 9. Electronic Mail Security: Pretty good privacy, Data Compression, PGP random number generator	3 hrs
Chapter No. 10. IP Security & Web Security IP security Architecture, Security Associations, Key management , Web security Considerations,Secure Socket layer, Transport layer security, secure electronic transactions	7 hrs

Text Book (List of books as mentioned in the approved syllabus)

1. William Stallings, Cryptography and Network Security-Principles and practices, 3rd, PHI, 2003
2. Atul Kahate , Cryptography and Network Security , TMH, 2003
3. Behrouz A. Forouzan, Cryptography and Network Security, TMH, 2007

References

1. Koeblitz, Introduction to Number theory and Cryptography , Springer, 0000

 KLE Technological University Creating Value Leveraging Knowledge Earlier known as B. V. B. College of Engineering & Technology	FORM ISO 9001: 2008 – BVBCET School of Electronics	Document #: FMCD2005	Rev: 1.0
	Title: Curriculum structure semester wise Electronics and Communication Engineering		Page 79 of 92 Year:

2. Bruce Schneider, Applied Cryptography, 2nd , John Wiley, 2001
3. Eric Maiwad, Fundamentals of Network security, 2nd , TMH, 2002

		Teaching Hours
Course Title: Embedded Linux		
Course Code: 18EECE405		
L-T-P-SS: 3-0-0-0	Credits: 3	Contact Hours: 3 Hrs/week
CIE Marks: 50	SEE Marks: 50	Total Marks: 100
Teaching Hours: 42Hrs	Examination Duration: 3 Hrs	
Unit I		
Chapter 1: Introduction to Embedded Linux : A Brief History of Linux -Benefits of Linux -Acquiring and Using Linux -Examining Linux Distributions - Devices and Drives in Linux-Components: Kernel, Distribution, Sawfish, and Gnome.		04 Hrs
		06 Hrs
		06 Hrs
Chapter 2: Overview of Embedded Linux : Overview: Development-Kernel architectures and device driver model- Embedded development issues-Tool chains in Embedded Linux-GNU Tool Chain (GCC,GDB, MAKE, GPROF & GCONV)- Linux Boot process.		
Chapter 3: System Management and user interface Boot sequence-System loading, sys linux, Lilo, grub-Root file system-Binaries required for system operation-Shared and static Libraries overview-Writing applications in user space-GUI environments for embedded Linux system		
Unit II		
		06 Hrs
		04 Hrs
		08 Hrs

 KLE Technological University Creating Value Leveraging Knowledge Earlier known as B. V. B. College of Engineering & Technology	FORM ISO 9001: 2008 – BVBCET School of Electronics	Document #: FMCD2005	Rev: 1.0
	Title: Curriculum structure semester wise Electronics and Communication Engineering		Page 80 of 92 Year:

<p>Chapter 4: File system in Linux: File system Hierarchy-File system Navigation -Managing the File system –Extended file systems-INODE-Group Descriptor-Directories-Virtual File systems- Performing File system Maintenance -Locating Files –Registering the File systems- Mounting and Un-mounting –Buffer cache-/proc file systems-Device special files</p> <p>Chapter 5:Configuration: Configuration, Compilation & Porting of Embedded Linux-Examining Shells -Using Variables - Examining Linux Configuration Script Files -Examining System Start-up Files -Creating a Shell Script</p> <p>Chapter 6: Process management and Inter process communication: Managing Process and Background Processes -Using the Process Table to Manage Processes - Introducing Delayed and Detached Jobs - Configuring and Managing Services -Starting and Stopping Services -Identifying Core and Non-critical Services -Configuring Basic Client Services -Configuring Basic Internet Services –Working with Modules. IPC-Benefits of IPC- Basic concepts-system calls-creating pipes-creating a FIFO-FIFO operations-IPC identifiers-IPC keys-IPCS commands- Message queues-Message buffer-Kernel Ring Buffer semaphores-semtools-shared memory semtools- signals-sockets</p>	
Unit III	
<p>Chapter 7: Linux device drivers Devices in Linux- User Space Driver APIs- Compiling, Loading and Exporting- Character Devices- Tracing and Debugging- Blocking and Wait Queues- Accessing Hardware- Handling Interrupts- Accessing PCI hardware- USB Drivers- Managing Time- Block Device Drivers- Network Drivers- Adding a Driver to the Kernel Tree.</p>	08 Hrs
<p><i>Text Books</i></p> <ol style="list-style-type: none"> 2. Embedded Linux –Hardware, Software and Interfacing - Craig Hollabaugh, Addison-Wesley Professional, 2002 3. Embedded / Real-Time Systems: Concepts, Design and Programming Black Book, New ed (MISL-DT) Paperback – 12 Nov 2003. <p><i>References</i></p> <ol style="list-style-type: none"> 3. Building Embedded Linux Systems, Karim Yaghmour, First edition, April 2003. 4. Embedded Linux- John Lombardo, Newriders.com 	

Course Code: 18EECE409	Course Title: Design and Analysis of Algorithms	
L-T-P: 2-1-2(3-0-2)	Credits: 3	Contact Hrs: 50
ISA Marks: 50	ESA Marks: 50	Total Marks: 100
	Semester: III	Exam Duration: 3 hrs

Content	
Unit - 1	Hrs

 KLE Technological University Creating Value Leveraging Knowledge Earlier known as B. V. B. College of Engineering & Technology	FORM	Document #: FMCD2005	Rev: 1.0
	ISO 9001: 2008 – BVBCET School of Electronics		
Title: Curriculum structure semester wise Electronics and Communication Engineering		Page 81 of 92	
		Year:	

Chapter No. 1 : Framework for Analysis of Algorithm Efficiency Analysis Framework, Asymptotic Notations and Basic Efficiency Classes, Mathematical Analysis of Non-Recursive Algorithms, Mathematical Analysis of Recursive Algorithms.	4
Chapter No 2: Trees and Graphs Overview of Trees. AVL Trees. Red – Black Trees. Graphs, DFS and its applications, BFS and its applications. Topological Sorting. Shortest path algorithms. Minimum Spanning Tree.	8
Chapter No 3 : Hashing Direct Address Table, Hash Table, Hash Function, Collision Resolution Techniques.	3
Unit - 2	
Chapter No 4 : Substring Matching and Sorting Techniques. Brute-force method, Boyer-Moore – Hoorspool Algorithm, Knuth-Morris-Pratt Algorithm, Bubble sort, selection sort. Divide and Conquer: insertion sort, merge sort, quick sort and heap sort	8
Chapter No 5: Greedy Technique Introduction, Interval Scheduling, Proof Strategies, Huffmann Coding, 0/1 knapsack	2
Chapter No 6: Dynamic Programming Introduction and Definition. Memorization, Fibonacci Series, Edit Distance, Longest Increasing Subsequence, Longest Common Subsequence, Matrix multiplication, Coin Change problem, Subset Sum problem.	5
Unit - 3	
Chapter No 7 : Backtracking Introduction. N-Queens Problem, Generating string permutation, Hamiltonian Cycle.	5
Chapter No 8 : Branch and Bound Introduction. Travelling Salesman problem, Job Assignment Problem.	5

Text Books:

1. Data Structures with C -- Seymour Lipschutz, Schaum's Outline Series
2. Introduction to Design and Analysis of Algorithms – Anany Levitin 3rd Edition

Reference Books:

1. Introduction to Algorithms – Thomas H. Cormen 3rd edition
2. Data Structures, Algorithms and Applications In C++ -- Satraj Sahani
3. Data Structures and Algorithms Made Easy – Narshiman Karumunchi, Career Monk

Course Title: Advanced Digital Logic Verification	Course code: 18EECE418	
L-T- P: 0-0-3	Credits: 03	Contact Hrs: 06hrs/week
CIE Marks: 100	SEE Marks: 00	Total Marks: 100

 KLE Technological University Creating Value Leveraging Knowledge Earlier known as B. V. B. College of Engineering & Technology	FORM ISO 9001: 2008 – BVBCET School of Electronics	Document #: FMCD2005	Rev: 1.0
	Title: Curriculum structure semester wise Electronics and Communication Engineering		Page 82 of 92 Year:

Teaching Hrs: 16hrs Lab Hrs: 24 hrs	
Chapter No. 1. Verification Concepts: Concepts of verification, importance of verification, Stimulus vs Verification, functional verification, test bench generation, functional verification approaches, typical verification flow, stimulus generation, direct testing, Coverage: Code and Functional coverage, coverage plan.	8 hrs
Chapter No. 2. Language Constructs System Verilog constructs: Data types: two-state data, strings, arrays: queues, dynamic and associative arrays, Structs, enumerated types. Program blocks, module, interfaces, clocking blocks, modports.	6 hrs
Chapter No. 3. Classes & Randomization SV Classes: Language evolution, Classes and objects, Class Variables and Methods, Class instantiation, Inheritance, and encapsulation, Polymorphism. Randomization: Directed Vs Random Testing. Randomization: Constraint Driven Randomization.	10 hrs
Chapter No. 4. Assertions & Coverage Assertions: Introduction to Assertion based verification, Immediate and concurrent assertions. Coverage driven verification: Motivation, Types of coverage, Cover Group, Cover Point, Cross Coverage, Concepts of Binning and event sampling.	8 hrs
Chapter No. 5. Building Testbench: Layered testbench architecture. Introduction to Universal Verification Methodology, Overview of UVM Base Classes and simulation phases in UVM and UVM macros. Unified messaging in UVM, UVM environment structure, Connecting DUT- Virtual Interface	8 hrs
References: 1. System Verilog LRM 2. Chris Spear, Gregory J Tumbush - SystemVerilog for verification - a guide to learning the testbench language features - Springer, 2012 3. Step-by-Step Functional Verification with SystemVerilog and OVM by Sasan Iman SiMantis Inc. Santa Clara, CA Spring 2008 Tools: Questa Sim, NC Verilog, NC Sim, CVER + GTKWave, VCSMX, Modelsim for Verilog	

Course Title: CMOS ASIC Design (PD-Digital)	Course code: 18EECE420	
L-T- P: 0-0-3	Credits: 03	Contact Hrs: 06hrs/week
CIE Marks: 100	SEE Marks: 00	Total Marks: 100
Teaching Hrs: 16hrs Lab Hrs: 24 hrs		
Chapter No. 1. Introduction: Design of combinational and sequential logic gates in CMOS. Layout and characterization of standard cells. Verilog for representing gate level netlists.	8 hrs	
Chapter No. 2. Timing Analysis: Sequential circuit timing and static timing analysis. Cell and net delays and cross-talk. Rationale and implementation of scan chains for testing standard-cell based logic circuits.	10hrs	

 KLE Technological University Creating Value Leveraging Knowledge Earlier known as B. V. B. College of Engineering & Technology	FORM ISO 9001: 2008 – BVBCET School of Electronics	Document #: FMCD2005	Rev: 1.0
	Title: Curriculum structure semester wise Electronics and Communication Engineering		Page 83 of 92 Year:

Timing Verification: Setup Timing Check, Hold Timing Check, Timing across Clock Domains		
Chapter No. 3: Physical design Physical design of standard-cell based CMOS ASICs: scan insertion, placement, and clock tree synthesis and routing. Netlist transformations at each step of the physical design process. Net parasitic and parasitic extraction. Use of PLLs for clock generation and de-skew.		12 hrs
Chapter No. 4. Standard Data formats: Standard data formats for representing technology and design: LEF, Liberty, SDC, DEF and SPEF. Clock gating and power gating for reduction of device power consumption. Design for reliability: electro- migration, wire self heat and ESD checks and fixes.		6 hrs
Chapter No. 5. Packaging An overview of package design and implementation and system level timing.		4 hrs
Reference Books: 1. The Design & Analysis of VLSI Circuits, L. A. Glassey & D. W. Dobbepahl, Addison Wesley Pub Co. 1985. 2. H. Bhatnagar, Advanced ASIC Chip Synthesis Using Synopsys Design Compiler Physical Compiler and PrimeTime, 2nd edition, 2001. 3. Static Timing Analysis for Nanometer Designs A Practical Approach, J. Bhasker • Rakesh Chadha, □ Springer Science+Business Media, LLC 2009		
Tools: Cadence Innovous, Encounter		

Course Code: 18EECE411	Course Title: Microwave & Antenna	
L-T-P: 3-0-0	Credits: 03	Contact Hrs: 40
CIE Marks: 50	SEE Marks: 50	Total Marks: 100
Teaching Hrs: 50		Exam Duration: 03 hrs

Content	Hrs
Unit - 1	
Chapter No. 1. Microwave Vacuum Tube Devices Introduction , Reflex Klystron , Problems	04
Chapter No. 2. Microwave components Directional couplers, Circulators, Magic T, Isolator, s-Matrix and Attenuators	08
Unit - 2	
Chapter No. 3. Antenna Parameters Introduction, Basic antenna parameters ,Pattern, Beam width, Radiation intensity, Beam efficiency, Directivity, Gain, Aperture, Effective height, Polarization, Antenna field zone, The radio communication link. Radiation resistance of Short electric dipole and half wave length antenna.	10
Chapter No. 4. Sources and Arrays Introduction, Point sources, Power patterns, Power theorem, Examples on power theorem, Directivity and beam width of point sources, Arrays of two isotropic point sources, Pattern multiplication, Linear	08

 KLE Technological University Creating Value Leveraging Knowledge Earlier known as B. V. B. College of Engineering & Technology	FORM ISO 9001: 2008 – BVBCET School of Electronics	Document #: FMCD2005	Rev: 1.0
	Title: Curriculum structure semester wise Electronics and Communication Engineering		Page 84 of 92 Year:

array of n isotropic point sources of equal amplitude and spacing, Broad side array, End fire array.	
Unit - 3	
Chapter No. 5. Antenna practice Yagi-Uda Antenna, Loop antenna, Horn antenna, Parabolic reflector, Helical antenna, Log periodic antenna, Mobile Station Antennas, Antennas for GPR : Pulse Bandwidth, Embedded Antennas, UWB Antennas for Digital Applications, The Plasma Antenna	10

Text Book (List of books as mentioned in the approved syllabus)

1. J.D.Kraus & Khan, MGH publication, "Antennas", 2006, third edition.
2. Samuel Y Liao, "Microwave Devices and Circuits", PHI Pearson Education, Third Edition.

References

2. F.E.Terman, "Electromagnetic and radio engineering" by, TMcH publication, second Edition.
3. E.C.Jordan, "Electromagnetic waves & radiating systems", PHI publication, second edition
4. C.A.Balnis, "Antenna theory and analysis and design", 1999, third edition.
5. K.D.Prasad, "Antenna and wave propagation" by '1990, first edition.
6. Annapurna Das, Sisir K Das, "Microwave engineering", TMH Publications 2001.

Course Code: 19EECE416	Course Title: Biosensor	
L-T-P: 0-0-3	Credits: 3	Contact Hrs: 72
ISA Marks: 100	ESA Marks: --	Total Marks: 100
Teaching Hrs: 72		Exam Duration: 3 hrs

Content	Hrs
Unit - 1	
Chapter No. 1. Basic Introduction to sensors Introduction to sensors: fundamental characteristics such as Sensitivity, linearity, repeatability, hysteresis, drift. Sensing Principles: optical sensors, electrochemical sensors, micromechanical sensors, surface Plasmon sensors, colorimetric Sensors, acoustic sensors	5 hrs
Chapter No. 2. Active Electrical Transducers Thermoelectric transducers, thermoelectric phenomenon, common thermocouple systems, piezoelectric transducers, piezoelectric phenomenon piezoelectric materials, piezoelectric force transducers, piezoelectric strain, piezoelectric torque transducers, piezoelectric pressure transducers, piezoelectric acceleration transducers. Magnetostrictive transducers Magnetostrictive force transducers, Magnetostrictive acceleration transducers, Magnetostrictive torsion transducers, Hall Effect transducers, and application of Hall transducer. Electromechanical transducers-Tachometers, variable reluctance tachometers Electrodynamic vibration transducers, Electromagnetic pressure electromagnetic flowmeter. Photoelectric transducers-photoelectric phenomenon, photoelectric transducers, Photo volatile transducers, Photo emissive transducers.	10 hrs

 KLE Technological University Creating Value Leveraging Knowledge Earlier known as B. V. B. College of Engineering & Technology	FORM ISO 9001: 2008 – BVBCET School of Electronics	Document #: FMCD2005	Rev: 1.0
			Title: Curriculum structure semester wise Electronics and Communication Engineering

Electrochemical transducers- basics of electrode potentials, reference electrodes, indicator electrodes, measurement of PH, measurement of bioelectric signals.	
Unit - 2	
Chapter No. 3. Passive electrical transducer Introduction, Resistive transducers- resistance thermometers, hot wire resistance transducers, Resistive displacement transducer, Resistive strain transducer, resistive pressure transducer, resistive optical radiation transducers. Inductive transducers-Inductive thickness transducers, Inductive displacement transducers, Movable core-type Inductive transducers, eddy current type Inductive transducers. Capacitive transducers-Capacitive thickness transducers, capacitive displacement transducers, capacitive moisture transducers Substrate and Wafers, Active Substrate Materials, Silicon as Substrate Material, Silicon Compounds, Silicon Piezo resistors, Gallium Arsenide, Quartz, Piezoelectric Crystals, Polymers, Packaging Materials.	5 hrs
Chapter No. 4. Microfabrication Technology Design of process flow for device fabrication for application in biology and medicine: Introduction to the Clean room and contaminants, Wafer cleaning processes (DI water, RCA, metallic impurities, etc.), Substrate materials: Silicon, polymer and PCB, Thermal oxidation: Wet and dry oxidation, thin film deposition techniques: PVD- DC and RF Magnetron Sputtering, thermal evaporation, e-beam evaporation, LPCVD, PLD. Types of masks: Hard and soft Lithography, Lithography – UV Photolithography, Soft lithography, additive manufacturing. Mask design and fabrication – Photo resists and mechanical mask such as stencils. Types of etching- Wet etching- anisotropic and Isotropic and dry etching RIE and DRIE. Device fabrication and inspection in the clean room.	10 hrs
Unit - 3	
Chapter No. 5. Biosensors Introduction: Biosensors and its applications in health care, agriculture, drug discovery and environmental monitoring. Devices for biology and medicine: Microfluidic channels, flow cytometry/ sorting, microchip using electrophoresis, force measurement with cantilevers, micro engineered devices for medical therapeutics, blood pressure sensors, devices for drug delivery, and devices for minimally invasive surgery.	5 hrs
Chapter No. 6. Biological components for detection Enzymes, antigen-antibody reaction, biochemical detection of analysts, organelles, whole cell, receptors, DNA probe, pesticide detection, sensors for pollutant gases. Surface chemistry: Immobilization of biorecognition element, Antigen-Antibody functionalization, and assay labels including radioisotopes, fluorophores, dyes.	5 hrs

Text Books (List of books as mentioned in the approved syllabus):

1. Fundamentals of Microfabrication and Nanotechnology by Marc J. Madou, 3rd edition. Taylor and Francis group.
2. Transducers and Instrumentation – D.V.S. Murthy, 2nd Edn, PHI Ltd, 2010.
3. A.P.F. Turner, I. Karube & G.S. Wilson: Biosensors: Fundamentals & Applications, Oxford University Press, Oxford, 1987.

 KLE Technological University Creating Value Leveraging Knowledge Earlier known as B. V. B. College of Engineering & Technology	FORM ISO 9001: 2008 – BVBCET School of Electronics	Document #: FMCD2005	Rev: 1.0
	Title: Curriculum structure semester wise Electronics and Communication Engineering		Page 86 of 92 Year:

References:

1. Ernest O. Doebelin : Measurement Systems, Application and Design, McGraw-Hill, 1985.
2. Richard S.C. Cobbold : Transducers for Biomedical Measurements: Principles and Applications, John Wiley & Sons, 1974
3. John G. Webster (ed.) : Medical Instrumentation - Application and Design; Houghton Mifflin Co., Boston, 1992.
4. Stephen D. Senturia : "Micro system Design", Kluwer Academic Publishers, 2001

Course Code: 20EECE406	Course Title: AUTOSAR	
L-T-P : 3-0-0	Credits: 3	Contact Hrs: 3 Hours
ISA Marks: 50	ESA Marks: 50	Total Marks: 100
Teaching Hrs: 40		Exam Duration: 3

Content	Hrs
Unit - 1	
Chapter No. 1: AUTOSAR Fundamentals Evolution of AUTOSAR – Motivations and Objectives AUTOSAR consortium – Stake holders – work Packages, AUTOSAR Partnership, Goals of the partnership, Organization of the partnership, AUTOSAR specification, AUTOSAR Current development status, BSW Conformance classes: ICC1, ICC2, ICC3, and Drawbacks of AUTOSAR.	8 hrs
Chapter No. 2: AUTOSAR layered Architecture AUTOSAR Basic software, Details on the various layers , Details on the stacks Virtual Function Bus (VFB) Concept Overview of AUTOSAR Methodology , Tools and Technologies for AUTOSAR AUTOSAR Application Software Component (SW-C) ,Types of SW-components AUTOSAR Run Time Environment (RTE): RTE Generation Process: Contract Phase, Generation Phase, MCAL, IO HW Abstraction Layer, Partial Networking, Multicore, J1939 Overview, AUTOSAR Ethernet, AUTOSAR E2E Overview , AUTOSAR XCP, Metamodel , From the model to the process , Software development process.	7 hrs
Unit - 2	
Chapter No. 3: Methodology of AUTOSAR and Communication in AUTOSAR CAN Communication, CAN FD, CANape, Application Layer and RTE, intra and inter ECU communication, Client-Server Communication, Sender-Receiver, Communication, CAN Driver, Communication Manager (ComM), Overview of Diagnostics Event and Communication Manager	10 hrs
Chapter No. 4: Overview about BSW constituents	5 hrs

 KLE Technological University Creating Value Leveraging Knowledge Earlier known as B. V. B. College of Engineering & Technology	FORM ISO 9001: 2008 – BVBCET School of Electronics	Document #: FMCD2005	Rev: 1.0
	Title: Curriculum structure semester wise Electronics and Communication Engineering		Page 87 of 92 Year:

BSW Constituents: Memory layer, COM and Services layer, ECU abstraction, AUTOSAR, Operating system, Interfaces: Standard interface, AUTOSAR standardized interface, BSW-RTE interface,(AUTOSAR interface), BSW-ECU hardware interface, Complex device drivers and BSW module configuration, AUTOSAR Integration.	
Unit - 3	
Chapter 5: MCAL and ECU abstraction Layer Microcontroller Drivers, Memory drivers: on-chip and off chip drivers, IO drivers(ADC, PWM, DIO), Communication drivers: CAN driver, LIN drivers, Flexrfay	5 hrs
Chapter 6: Service Layer Diagnostic Event Manager, Function inhibits Manager, Diagnostic communication manager, Network management, Protocol data unit router, Diagnostic log and trace unit, COMM manager.	5 hrs
Text Book (List of books as mentioned in the approved syllabus) 1. Ronald K. Jurgen, Infotainment systems, 2007, SAE International, 2007	

Course Code: 21EECE421	Course Title: RF VLSI	
L-T-P : 3-0-0	Credits: 3	Contact Hrs: 3 Hours
ISA Marks: 50	ESA Marks: 50	Total Marks: 100
Teaching Hrs: 40		Exam Duration: 3
Content		Hrs
Unit - 1		
Chapter No. 1: Basic concepts in RF Design Basic concepts in RF Design – harmonics, gain compression, desensitization, blocking, cross modulation, intermodulation, inter symbol interference, noise figure, Friis formula, sensitivity and dynamic range.		8 hrs
Chapter No. 2: Receiver architectures Receiver architectures – heterodyne receivers, homodyne receivers, image-reject receivers, digital-IF receivers and subsampling receivers.		7 hrs
Unit - 2		
Chapter No. 3: Transmitter architectures Transmitter architectures – direct-conversion transmitters, two-step transmitters; Low noise amplifier (LNA) – general considerations, input matching, CMOS LNAs		10 hrs

 KLE Technological University Creating Value Leveraging Knowledge Earlier known as B. V. B. College of Engineering & Technology	FORM ISO 9001: 2008 – BVBCET School of Electronics	Document #: FMCD2005	Rev: 1.0
	Title: Curriculum structure semester wise Electronics and Communication Engineering		Page 88 of 92 Year:

Chapter No. 4: Mixers	5 hrs
Down conversion mixers – general considerations, spur-chart, CMOS mixers	
Unit - 3	
Chapter 5: Oscillators	10 hrs
Oscillators – Basic topologies, VCO, phase noise, CMOS LC oscillators; PLLs – Basic concepts, phase noise in PLLs, different architectures	
Text Books: Behzad Razavi, RF Microelectronics, Prentice Hall PTR, 1997 Thomas H. Lee, The design of CMOS radio-frequency integrated circuit, Cambridge University Press, 2006 Chris Bowick, RF Circuit Design, Newnes, 2007	

Course Code: 21EECE423		Course Title: CAD for VLSI	
L-T-P : 3-0-0		Credits: 3	Contact Hrs: 3 Hours
ISA Marks: 50		ESA Marks: 50	Total Marks: 100
Teaching Hrs: 40			Exam Duration: 3
Content			Hrs
Unit - 1			
Chapter No. 1: Introduction Introduction to VLSI design methodologies and supporting CAD environment. Schematic editors: Parsing: Reading files, describing data formats, Graphics & Plotting Layout. Layout Editor: Turning plotter into an editor. Layout language: Parameterized cells, PLA generators.			8 hrs
Chapter No. 2: Silicon Compiler Introduction to Silicon compiler, Data path, Compiler, Placement & routing, Floor planning.			7 hrs
Unit - 2			
Chapter No. 3: Layout Analysis and Simulations			10 hrs

 KLE Technological University Creating Value Leveraging Knowledge Earlier known as B. V. B. College of Engineering & Technology	FORM ISO 9001: 2008 – BVBCET School of Electronics	Document #: FMCD2005	Rev: 1.0
	Title: Curriculum structure semester wise Electronics and Communication Engineering		Page 89 of 92 Year:

Layout Analysis: Design rules, Object based DRC, Edge based layout operations. Module generators. Simulation: Types of simulation, Behavioral simulator, logic simulator, functional simulator & Circuit simulator. Simulation Algorithms: Compiled code and Event-driven. Optimization Algorithms: Greedy methods, simulated annealing, genetic algorithm and neural models.	
Chapter No. 4: Testing ICs Testing ICs: Fault simulation, Aids for test generation and testing. Computational complexity issues: Big Oh and big omega terms.	5 hrs
Unit - 3	
Chapter 5: Recent Topics in CAD-VLSI Recent topics in CAD-VLSI: Array compilers, hardware software co-design, high-level synthesis tools and VHDL modeling.	10 hrs
Text Books: 1. Stephen Trimberger, "Introduction to CAD for VLSI", Kluwer Academic publisher, 2002 2. Naveed Shervani, "Algorithms for VLSI physical design Automation", Kluwer Academic Publisher, Second edition.	
Reference Books 1. Gaynor E. Taylor, G. Russell, "Algorithmic and Knowledge Based CAD for VLSI", Peter peregrinus ltd. London. 2. Gerez, "Algorithms VLSI Design Automation", John Wiley & Sons.	

Course Code: 21EECE424	Course Title: System on Chip Design	
L-T-P : 3-0-0	Credits: 3	Contact Hrs: 3 Hours
ISA Marks: 50	ESA Marks: 50	Total Marks: 100
Teaching Hrs: 40		Exam Duration: 3
Content		Hrs
Unit - 1		
Chapter No. 1: Introduction Introduction: Driving Forces for SoC - Components of SoC - Design flow of SoC Hardware/Software nature of SoC - Design Trade-offs - SoC Applications		5 hrs

 KLE Technological University Creating Value Leveraging Knowledge Earlier known as B. V. B. College of Engineering & Technology	FORM ISO 9001: 2008 – BVBCET School of Electronics	Document #: FMCD2005	Rev: 1.0
Title: Curriculum structure semester wise Electronics and Communication Engineering		Page 90 of 92 Year:	

Chapter No. 2: System Level Design System-level Design: Processor selection-Concepts in Processor Architecture: Instruction set architecture (ISA), elements in Instruction Handling-Robust processors: Vector processor, VLIW, Superscalar, CISC, RISC—Processor evolution: Soft and Firm processors, Custom Designed processors- on-chip memory.	10 hrs
Unit - 2	
Chapter No. 3: On-chip bus and IP based design Interconnection: On-chip Buses: basic architecture, topologies, arbitration and protocols, Bus standards: AMBA, Core Connect, Wishbone, Avalon - Network-on chip: Architecture topologies-switching strategies - routing algorithms flow control, Quality-of-Service- Reconfigurability in communication architectures. IP based system design: Introduction to IP Based design, Types of IP, IP across design hierarchy, IP life cycle, Creating and using IP - Technical concerns on IP reuse – IP integration - IP evaluation on FPGA prototypes.	10 hrs
Chapter No. 4: SoC Implementation SOC implementation: Study of processor IP, Memory IP, wrapper Design - Real-time operating system (RTOS), Peripheral interface and components, High-density FPGAs - EDA tools used for SOC design.	5 hrs
Unit - 3	
Chapter 5: SoC Testing SOC testing: Manufacturing test of SoC: Core layer, system layer, application layer-P1500 Wrapper Standardization-SoC Test Automation (STAT).	10 hrs
Text Books: 1. Michael J.Flynn, Wayne Luk, “Computer system Design: Systemon-Chip”, Wiley-India, 2012. 2. Sudeep Pasricha, Nikil Dutt, “On Chip Communication Architectures: System on Chip Interconnect”, Morgan Kaufmann Publishers, 2008. 3. W.H.Wolf, “Computers as Components: Principles of Embedded Computing System Design”, Elsevier, 2008. Reference Books 1. Patrick Schaumont “A Practical Introduction to Hardware/Software Co-design”, 2nd Edition, Springer, 2012. 2. Lin, Y-L.S. (ed.), “Essential issues in SOC design: designing complex systems-on-chip. Springer, 2006. 3. Wayne Wolf, “Modern VLSI Design: IP Based Design”, Prentice-Hall India, Fourth edition, 2009.	

Course Code: 21EECE422	Course Title: Speech Processing
------------------------	---------------------------------

 KLE Technological University Creating Value Leveraging Knowledge Earlier known as B. V. B. College of Engineering & Technology	FORM	Document #: FMCD2005	Rev: 1.0
	ISO 9001: 2008 – BVBCET		
Title: Curriculum structure semester wise Electronics and Communication Engineering			Page 91 of 92
			Year:

L-T-P : 3-0-0	Credits: 3	Contact Hrs: 3 Hours
ISA Marks: 50	ESA Marks: 50	Total Marks: 100
Teaching Hrs: 40		Exam Duration: 3
Content		Hrs
Unit - 1		
Chapter No. 1: Introduction Basic Concepts: Speech Fundamentals: Articulatory Phonetics – Production and Classification of Speech Sounds; Acoustic Phonetics – acoustics of speech production; Review of Digital Signal Processing concepts; Short-Time Fourier Transform, Filter-Bank and LPC Methods.		5 hrs
Chapter No. 2: Speech Analysis Features, Feature Extraction and Pattern Comparison Techniques: Speech distortion measures – mathematical and perceptual – Log Spectral Distance, Cepstral Distances, Weighted Cepstral Distances and Filtering, Likelihood Distortions, Spectral Distortion using a Warped Frequency Scale, LPC, PLP and MFCC Coefficients, Time Alignment and Normalization – Dynamic Time Warping, Multiple Time – Alignment Paths.		10 hrs
Unit - 2		
Chapter No. 3: Speech Modeling Hidden Markov Models: Markov Processes, HMMs – Evaluation, Optimal State Sequence – Viterbi Search, Baum-Welch Parameter Re-estimation, Implementation issues		10 hrs
Chapter No. 4: Speech Recognition Large Vocabulary Continuous Speech Recognition: Architecture of a large vocabulary continuous speech recognition system – acoustics and language models – n-grams, context dependent sub-word units; Applications and present status.		5 hrs
Unit - 3		
Chapter 5: Speech Synthesis Text-to-Speech Synthesis: Concatenative and waveform synthesis methods, subword units for TTS, intelligibility and naturalness – role of prosody, Applications and present status.		10 hrs
Text Books: 1.Lawrence Rabiner and Biing-Hwang Juang, “Fundamentals of Speech Recognition”, Pearson Education, 2003. 2.Daniel Jurafsky and James H Martin, “Speech and Language Processing – An Introduction to Natural Language Processing, Computational Linguistics, and Speech Recognition”, Pearson Education.		
Reference Books 1.Steven W. Smith, “The Scientist and Engineer’s Guide to Digital Signal Processing”, California Technical Publishing.		

 KLE Technological University Creating Value Leveraging Knowledge Earlier known as B. V. B. College of Engineering & Technology	FORM ISO 9001: 2008 – BVBCET School of Electronics	Document #: FMCD2005	Rev: 1.0
Title: Curriculum structure semester wise Electronics and Communication Engineering			Page 92 of 92 Year:

2. Thomas F Quatieri, "Discrete-Time Speech Signal Processing – Principles and Practice", Pearson Education. 3. Claudio Becchetti and Lucio Prina Ricotti, "Speech Recognition", John Wiley and Sons, 1999.

4. Ben gold and Nelson Morgan, "Speech and audio signal processing", processing and perception of speech and music, Wiley- India Edition, 2006 Edition.

5. Frederick Jelinek, "Statistical Methods of Speech Recognition", MIT Press.

School of Management Studies and Research

Course Code: 22MBAC701		Course Title: Business Research methods	
L-T-P: 3-0-0		Credits: 3	Contact Hrs: 03 Sessions/week
ISA Marks: 50		ESA Marks: 50	Total Marks: 100
Teaching Hrs: 40hrs			Exam Duration: 3 hrs
Course Content			
Particulars			Hours
Module 1: Introduction to business research: Meaning and objectives of research, Research Types, Qualitative and Quantitative approaches to research, Qualitative research – Focus group, case study, ethnography etc. advantages and limitations of qualitative and quantitative research, Quantitative Research Designs, Stages of research process, Characteristics of a Good Research.			08Hrs
Module 2: Review of Literature Introduction to Primary & Secondary data Review of literature: importance, purpose& process, types of literature reviews; critical, scooping, conceptual review etc, structuring literature review, characteristics of a good research review, sources for review of literature, process of literature review.			08Hrs
Module3: Problem definition and hypothesis formulation: Research problem, definition of a research problem, identifying the problem, Use of secondary data in defining the problem, Review of literature and problem definition, Research Data bases, Stating the problem as hypothesis: hypothesis, setting of the hypothesis, need for hypothesis.			08Hrs
Module 4: Data Collection and summarization: Use of primary data in testing the hypothesis Levels of measurement: Nominal, Ordinal, Interval, Ratio Scale, Census, Sampling, sampling techniques-probabilistic and non-probabilistic, Primary data collection, Questionnaire design, types of questions, Tabulation, frequency tables, charts and graphs, data summarization.			10Hrs
Module 5: Report Writing & Ethics in Research: Report writing and ethics of research: Layout of the report, report writing and presentation, Plagiarism, ethical issues.			06Hrs
References: <ul style="list-style-type: none"> • Cooper and Schlinder, <i>Business Research Methods</i>, TMH • William Zikmund, <i>Business Research Methods</i>, Cengage Publication • G. C. Ramamurthy, <i>Research Methodology</i>, Dreamtech Press • Uma Sekaran and Roger Bougie, <i>Research Methods for Business</i>, Wiley Publications • Uwe Flick, <i>An Introduction to Qualitative Research</i>, Sage Publications • Gerard Guthrie, <i>Basic Research Methods</i>, Sage Publications • G. C. Beri, 2005, <i>Business Statistics</i>, 2nd edition, Tata McGraw-Hill. • R I Lewin and David S Rubin, <i>Statistics for Management</i>, 7th edition, Pearson. • Robert E. Stine, Dean Foster, <i>Statistics for Business: Decision Making and Analysis</i>, 1st edition, Pearson. • J K Sharma, <i>Business Statistics</i>, 2rd edition, Pearson 			

School of Management Studies and Research

Course Code: 22MBAE831	Course Title: Data Science for Managers	
L-T-P: 3-0-0	Credits: 3	Contact Hrs: 03 Sessions/week
ISA Marks: 50	ESA Marks: 50	Total Marks: 100
Teaching Hrs: 40hrs		Exam Duration: 3 hrs
Course Content		
Particulars	Hours	
Module 1: Introduction What is data science, Why Data Science, Applications for data science, Data Scientists Roles and Responsibility? , Data Science vs. Data Analytics, Data Science in Business, Market basket analysis, Natural Language processing, Network analysis, Data wrangling , Supervised learning, unsupervised learning.	08hrs	
Module 2: Analytics Process What is Analytics, objectives of analytics, steps in analytics process, Types of Analytics: Big Data Analytics, Web and Social Media, Analytics project proposal, modeling process, Application of models.	08 hrs	
Module 3: Model & Analysis Descriptive Analytics (Types of data measurement scale, data visualization), Predictive Analytics (Regression, logistic & passion regression-nearest neighbors, random forest, clustering and neural networks), Prescriptive Analytics (linear programming, integer programming, multi-criteria decision-making models such as goal programming and analytic hierarchy process) ,analytics using orange ,SPSS and MS Excel.	10 hrs	
Module 4: Models Implementation Descriptive application models, Predictive application models, Model Management (Model objective, Access and manage data, validate data, deploy of the model, model monitoring.	06 hrs	
Module 5: Data Visualization tools: Creating common visualizations (basic graphs using tools), analyzing different data sets, introduction to Power Bi, Tableau and Google charts .	08 hrs	
References: <ul style="list-style-type: none"> • Business Analytics: For Decision Making ,Regi Mathew,Pearson Publications • Business Analytics: The Science of Data driven decion making, U Dinesh Kumar, Wiley • Essentials of Business Analytics: An Introduction to the methodology and its application, Bhimasankaram Pochiraju, SridharSeshadri, Springer • Introduction to Data Science, Laura Igual Santi Seguí, Springer. 		

School of Management Studies and Research

Course Code: 22MBAE821	Course Title: HR Analytics	
L-T-P: 3-0-0	Credits: 3	Contact Hrs: 03 Sessions/week
ISA Marks: 50	ESA Marks: 50	Total Marks: 100
Teaching Hrs: 40hrs		Exam Duration: 3 hrs
Course Content		
Particulars		Hours
Module 1: HR Analytics in Perspective: Traditional HRM, Changing Trends in HRM and Emergence of Strategic HRM, Role of Analytics, Defining HR Analytics, HR Analytics: The Third Wave for HR value creation, HR Measurement journey in tune with HR maturity journey Understanding the organizational system (Lean), Locating the HR challenge in the system, Valuing HR Analytics in the organizational system		08 hrs
Module 2: Understanding HR Analytics: Introduction, How to Conduct a Purposeful Workforce Analytics, Key Influencers in the HR Analytics Process, Model for Adoption of HR Analytics, Application and Status of HR Analytics HRA Frameworks: Current approaches to measuring HR and reporting value from HR contributions, Strategic HR Metrics versus Benchmarking, HR Scorecards & Workforce Scorecards and how they are different from HR Analytics,		08 hrs
Module 3: HR Analytics Tools and Techniques: Importance of Data, Types of Data, Data-Capturing Methods, Data Examination and Purification Data Analyzing Techniques, Types of HR Analytics: Descriptive, Predictive and Perspective analytics. Case study on types of analytics.		08 hrs
Module 4: Insight into Data Driven HRA: Typical data sources, Typical questions faced (survey), Typical data issues, Connecting HR Analytics to business benefit (case studies), Techniques for establishing questions, Building support and interest, Obtaining data, Cleaning data (exercise), Supplementing data. HR Metrics: Defining metrics, Demographics, data sources and requirements, Types of data, tying data sets together, Difficulties in obtaining data, ethics of measurement and evaluation. Human capital analytics continuum.		08 hrs
Module 5: HR Dashboards: Statistical software used for HR analytics: MS-Excel, IBM- SPSS, IBMAMOS, SAS, and R programming and data visualisation tools such as Tableau, Plotly, Click view and Fusion Charts.		08 hrs
References: <ul style="list-style-type: none"> • Moore, McCabe, Duckworth, and Alwan. The Practice of Business Statistics: Using Data for Decisions, Second Edition, New York: W.H.Freeman, 2008. • Predictive analytics for Human Resources, Jac Fitz-enz, John R. Mattox, II, Wiley, 2014. • Human Capital Analytics: Gene Pease Boyce Byerly, Jac Fitz-enz, Wiley, 2013. • The HR Scorecard: Linking People, Strategy, and Performance, by Brian E. Becker, Mark A. Huselid, Mark A Huselid, David Ulrich, 2001. • HR Analytics: The What, Why and How, by Tracey Smith 		

School of Management Studies and Research

Course Code: 22MBAP802	Course Title: Social Entrepreneurship Phase – I	
L-T-P: 0-0-3	Credits: 3	Contact Hrs: 06 Sessions/week
ISA Marks: 100	ESA Marks: --	Total Marks: 100
Teaching Hrs: 90hrs		Exam Duration: -- hrs
Course Content		
Particulars		Hours
Prerequisite: Rural Immersion Phase II Students are expected to work on the following activities: <ol style="list-style-type: none"> 1. Discuss what social entrepreneurship is and how it differs from business entrepreneurship 2. Following certain biography exercises, identify your skills and gifts 3. Identify characteristics of successful social entrepreneurs 4. Identify areas of our economy/society where social entrepreneurs work 5. Translate a social problem into an opportunity 6. Prepare a report to create an implementation 		90 hrs



1.1.3 & 1.2.1 MCA courses having focus on employability/ entrepreneurship/ skill development offered by the University during the year July 2021 to June 2022.

Big Data Analytics		20ECAC801
Course Code: 20ECAC801	Course Title: Big Data Analytics	
L-T-P: 3-0-1	Credits: 4	Contact Hrs: 5
ISA Marks: 50	ESA Marks: 50	Total Marks: 100
Teaching Hrs: 40+24	Exam Duration: 3 hrs	
No	Content	Hrs
Unit I		
1	Chapter 1: Types of digital data and concept of big data Classification of digital data: Unstructured, Semi-structured, and Structured; Characteristics of data, Evolution of big data, and definition of big data: 5 Vs, challenges with big data, typical data warehouse environment: Hadoop Environment.	4
2	Chapter 2: Big Data Analytics What is big data analytics? What big data analytics is not? Classification of analytics, Top challenges facing big data, Importance of big data analytics, Need of technology to meet big data challenges, Data science: business acumen skills, technology expertise, mathematics expertise, Data scientist, terminologies used in big data environments, BASE, top analytics tools.	8
3	Chapter 3: Big data technology landscape Not Only SQL (NOSQL): Types of NoSQL, Advantages of NoSQL, Use of NoSQL in industry, NewSQL, Hadoop: features, key advantages, versions, overview of Hadoop ecosystem, Hadoop distributions, Hadoop versus SQL, Cloud-based Hadoop solutions.	4
Unit II		
4	Chapter 4: Hadoop distributed file system Introduction, Why Hadoop, RDBMS versus Hadoop, distributed computing challenges: hardware failure, how to process gigantic store of data, history of Hadoop, Hadoop overview, use case of Hadoop, Hadoop distributors, Hadoop Distributed File System (HDFS): Name node, Data node, secondary Name node, anatomy of file read, anatomy of file write; replica placement, processing of data with Hadoop, Managing resources an applications with Hadoop, Interacting with Hadoop ecosystem.	8 Hrs
5	Chapter 5: MongoDB and query language Introduction, Why MongoDB, Terms used in RDBMS and MongoDB, data types in MongoDB, MongoDB query language: basic functions, Arrays, aggregate functions, MapReduce function, Java script programming, Cursors in MongoDB, MongoImport and MongoExport.	4 Hrs
6	Chapter 6: Cassandra and MapReduce programming Introduction, Apache Cassandra, features of Cassandra, data types, CQLSH, Keyspaces, CRUD operations, Introduction to MapReduce, Mapper, Reducer, Combiner, partitioner, searching, Sorting, and compression.	4 Hrs
Unit – III		
7	Chapter 7: Hive and query language Introduction, What is Hive, History of Hive and recent releases of Hive, Hive integration and work flow, Hive data units; Hive architecture, Hive data types, Hive file format, Hive Query Language (HQL): DDL, DML, Hive shell, database,	4 Hrs



1.1.3 & 1.2.1 MCA courses having focus on employability/ entrepreneurship/ skill development offered by the University during the year July 2021 to June 2022.

tables, Partitions, Bucketing, Views, Sub-query: RCFile implementation, SERDE, User defined function.

8 Chapter 8: PIG **4 Hrs**

Introduction, What is PIG, Key features of PIG; The anatomy of PIG, PIG philosophy, use case for PIG: ETL processing, PIG Latin overview, Data types in PIG, Running PIG, execution modes of PIG, HDFS commands, relational operators, eval function, complex data types, piggy bank, user defined function.

Text Book

1. Seema Acharya, Subhashini Chellapan, Big Data and Analytics, First edition, 2015, Wiley publications.

References

1. EMC Education Services, Data Science and Big Data Analytics: Discovering, Analyzing, Visualizing and Presenting Data, Wiley Publications.
2. Frank J Ohlhorst, Big Data Analytics: Turning Big Data into Big Moneyll, Wiley and SAS Business Series, 2012.
3. Colleen Mccue, Data Mining and Predictive Analysis: Intelligence Gathering and Crime Analysisll, Elsevier, 2007.
4. Michael Berthold, David J. Hand, Intelligent Data Analysis, Springer, 2007.
5. Bill Franks, Taming the Big Data Tidal Wave: Finding Opportunities in Huge Data Streams with Advanced Analyticsll, Wiley and SAS Business Series, 2012.
6. Paul Zikopoulos, Chris Eaton, Paul Zikopoulos, Understanding Big Data: Analytics for Enterprise Class Hadoop and Streaming Datall, McGraw Hill, 2011.
7. Jiawei Han, Micheline Kamber, Data Mining Concepts and Techniquesll, Second Edition, Elsevier, Reprinted 2008.

ACTIVITY

#	TOPICS	ACTIVITY	WEIGHTAGE
1	Types of digital data and concept of big data	Identify the various types of data, such as, SD, USD and SSD present in any given business and also justify its importance for business growth. Prepare technical report for the same.	10
2	Big Data Analytics	Prepare survey paper on BDA with issues, challenges and applications.	10
3	Big data technology landscape	Demonstration of graph database management system using Neo4j and Cypher query language. Data set: Movie database, Twitter followers database, Twitter Sentiment Graph Data, Graph dataset in Kaggle.	20
4	Hadoop distributed file system	Demonstration of HDFS commands	20



1.1.3 & 1.2.1 MCA courses having focus on employability/ entrepreneurship/ skill development offered by the University during the year July 2021 to June 2022.

		Hadoop Implementation of MapReduce programming for Word count problem, Totals sales and Max temperature problem.	
5	MongoDB and query language	Demonstration of CRUD operations in MongoDB. MongoDB built-in functions and UDF Implementation of MapReduce functions in MongoDB for log data analysis. Integration of JavaScript with MongoDB, Loading of large data into MongoDB	15
6	Cassandra No SQL database	Cassandra Keyspace Operations Cassandra Table Operations Cassandra CRUD Operations Cassandra CQL operations & Data Expiration using TTL (Example) Cassandra Collection: Set, List, Map with Example	10
7	Hive and query language	Hive CRUD operations Hive – Partitioning Hive - View and Indexes HiveQL operations Hive Function: Built-in & UDF (User Defined Functions) Hive ETL: Loading JSON, XML, Text Data Examples	15
8	PIG	Apache Pig - Grunt Shell demonstration Pig Latin – Demonstration Apache Pig - Reading Data Apache Pig - Storing Data Pig Latin: Built in Functions and UDF MapReduce implementation	10
		Total	100

Evaluation Scheme

1. In Semester Assessment (ISA)

Assessment	Marks
ISA- 1	15
ISA- 2	15
Activities	20
ISA	50
ESA	50
Total	100

2. End Semester Assessment (ESA)

UNIT	8 Questions to be set of 20 Marks Each	Chapter Nos.	Instructions
I	3 Questions to be set of 20 Marks Each	1, 2, 3	Any 2 questions are to be answered
II	3 Questions to be set of 20 Marks Each	4, 5,6	Any 2 questions are to be answered
III	2 Questions to be set of 20 Marks Each	7,8	Any 1 question is to be answered



1.1.3 & 1.2.1 MCA courses having focus on employability/ entrepreneurship/ skill development offered by the University during the year July 2021 to June 2022.

Programming using C# with .Net	20ECAC802
Course Code: 20ECAC802	Course Title: Programming Using C# with .NET
L-T-P: 3-0-1	Credits: 4 Contact Hrs: 5
ISA Marks: 50	ESA Marks: 50 Total Marks: 100
Teaching Hrs: 40+24	Exam Duration: 3 hrs
Content	Hrs
Unit – 1	
Chapter No. 1.The Philosophy of .NET	6 hrs
Understanding the Previous State of Affairs, The .NET Solution, Introducing the Building Blocks of the .NET Platform (CLR,CTS, and CLS), The Role of the .NET Base Class Libraries, What C# Brings to the Table, An Overview of .NET Assemblies, The Role of the Common Intermediate Language , The Role of .NET Type Metadata, The Role of the Assembly Manifest, Compiling CIL to Platform –Specific Instructions, Understanding the Common Type System, Intrinsic CTS Data Types, Understanding the Common Languages Specification, Understanding the Common Language Runtime, The Assembly/namespace/type Distinction, Using ildasm.exe, Deploying the .NET Runtime, The Platform independent nature of .NET, Installing the .NET Framework, C# Command-Line Compiler, Building C# Applications using csc.exe, Working with csc.exe Response Files.	
Chapter No. 2.C# Language Fundamentals.	5 hrs
The Anatomy of a Simple C# Class, An Interesting Aside : The System.Environment Class, Defining Classes and Creating objects, The System.Console Class, Establishing Member Visibility, Default Values of Class Member Variables, Member Variable Initialization Syntax, Defining Constant Data, Defining Read-only fields, Understanding the static keyword, Method Parameter Modifiers, Iteration Constructs, Decision Constructs and the Relational/Equality Operators, Understanding Value Types and Reference Types, Understanding Boxing and Unboxing Operations, Working with .NET Enumerations, The Master Class: System.Object, Overriding some default behaviours of System.Object, The System Data types(and C# Shorthand notation), The System.String data types, The role of System.Text.StringBuilder, .NET Array Types, Understanding C# Nullable Types, Defining Custom Namespaces	
Chapter No. 3. Object-Oriented Programming with C#	5 hrs
Understanding the C# Class Type, Reviewing the Pillars of OOP, The First Pillar: C#'s Encapsulation Services, The Second Pillar: C#'s Inheritance Support, Programming for Containment/Delegation, The Third Pillar: C #'s Polymorphic Support, C# Casting rules, Understanding C# Partial types, Documenting C# Source Code via XML	
Unit – 2	
Chapter No. 4.Object Lifetime and Exceptions Handling.	6 hrs
Classes, Objects and References, the basics of Object Lifetime, The role of Application Roots, Understanding Object Generations, System.GC type, Building Finalizable Objects, Building Disposable Objects, Building Finalizable and Disposable types. Ode to Errors, Bugs, and Exceptions, The Role of .NET Exception Handling, The Simplest possible example, Configuring the state of an exception, System – Level Exception (System. System Exception), Application-Level Exception (System.ApplicationException), Processing Multiple Exception, The Finally Block, The result of unhandled exceptions, Debugging Unhandled exceptions using VS. NET.	



1.1.3 & 1.2.1 MCA courses having focus on employability/ entrepreneurship/ skill development offered by the University during the year July 2021 to June 2022.

Chapter No. 5.Interfaces and Collections

5 hrs

Defining Interfaces in C#, Implementing an Interface in C#, Contrasting Interfaces to Abstract Base Classes, Invoking Interface Members at the Object Level, Interfaces As Parameters, Interfaces As Return Values, Arrays of Interfaces Types, Understanding Explicit Interface Implementation, Building Interface Hierarchies, Implementing Interfaces Using Visual Studio 2005, Building Enumerable Types(IEnumerable and IEnumerator),

Building CloneableObjects(IConeable), Building Comparable Objects(IComparable), The Interfaces of the System.Collections Namespace, The Class Types of System.Collections.

Chapter No. 6.Callback Interfaces, Delegates, and Events, Advanced C# Techniques

5 hrs

Understanding Callback Interfaces, Understanding the .NET Delegate type, Defining a Delegate in C#, The System.multicastDelegate and System.Delegate Base Classes, Investigating a Delegate Object, Delegates as Parameters, Understanding C# Events Building a Custom Indexer, Internal Representations of Type Indexers: Final Details, Understanding Operator Overloading Binary Operators, Unary Operators, Equality Operators, Comparison Operators, Understanding Custom Type Conversions, The Advanced Key words of C#, C# Preprocessor Directives.

Unit – 3

Chapter No. 7.Programming with Windows Forms.

4 hrs

Controls - Labels, Text boxes, Masked Text boxes, Buttons, Check boxes, Radio Buttons, Group Boxes, Checked List Boxes, List Boxes, Combo Boxes, Configuring the Tab Order, Setting the Form's Default Input Button, Working with more Exotic Controls – Month Calendars, Tool Tips, Tab Controls, Track Bars, Panels, Up Down Controls, Error Providers, Tree Views, Web Browsers, Building Custom Windows Forms Controls – Creating Images, Building Design-Time UI, Defining Custom Events, Defining Custom Properties.

Chapter No. 8. Database Access with MSSQL Server

4 hrs

Overview of Data Access, Creating database connections, connecting to MSSQL Server, Dataset and Data table features, using inline SQL Statements, using stored procedures , Executing select commands, SQL transaction

Text Book:

1. Andrew Troelsen: Pro C# with .NET 3.0, Special Edition, Dream tech Press, India, 2007.Chapters: 1 to 11 (up to pp.389, except Chapter 10)

References:

1. .NET 4.0 Programming (6-in-1),Black Book,Kogent Learning Solutions Inc.Wiely-Dream Tech Press
2. Tom Archer: Inside C#, WP Publishers, 2001.
3. Herbert Schildt: The Complete Reference C#,Tata McGraw Hill, 2004



1.1.3 & 1.2.1 MCA courses having focus on employability/ entrepreneurship/ skill development offered by the University during the year July 2021 to June 2022.

Activities			
#	Topics	ACTIVITY	WEIGHT
1	The Philosophy of .NET	<ul style="list-style-type: none"> Installing .NET and CSC.EXE compiler. Working with CSC.EXE compiler. Installing Visual Studio IDE. Understanding .NET Environment. 	10
2	C# Language Fundamentals.	<ul style="list-style-type: none"> Programs on static variables, functions, class, and method parameter modifiers. Programs on Boxing and Unboxing. Creating custom namespace. 	10
3	Object-Oriented Programming with C#	<ul style="list-style-type: none"> Implementation of Encapsulation, Inheritance and Polymorphism concepts using Banking or Insurance case studies. Programs on partial types, and casting. 	10
4	Object Lifetime and Exceptions Handling	<ul style="list-style-type: none"> Programs on Exception handling. Programs on object life time. 	
5	Interfaces and Collections	<ul style="list-style-type: none"> Implementation of interface and collections using Banking or Insurance case studies. Creating own interface and Interface Hierarchies. 	10
6	Callback Interfaces, Delegates, and Events, Advanced C# Techniques	<ul style="list-style-type: none"> Implementation of callback interface, delegates and events using basic functionality of vehicle. Programs on Advanced C# Techniques like operator overloading, custom indexer and preprocessor directives 	20
7	Programming with Windows Forms.	<ul style="list-style-type: none"> Implementing windows form application for HRMS user interface design. Creating custom controllers. Understanding MVC Pattern. Working with ASP.NET controllers. 	20
8	Database Access with MSSQL Server	<ul style="list-style-type: none"> Implementing session management in ASP.NET web application. Developing an ASP.NET web application to interact with Database. 	20
			100
Evaluation Scheme			
1.	In Semester Assessment (ISA)		
	Assessment	Marks	



1.1.3 & 1.2.1 MCA courses having focus on employability/ entrepreneurship/ skill development offered by the University during the year July 2021 to June 2022.

ISA- 1	20
ISA- 2	20
Activities	10
ISA	50
ESA	50
Total	100

2. End Semester Assessment (ESA)

UNIT	8 Questions to be set of 20 Marks Each	Chapter Nos.	Instructions
I	3 Questions to be set of 20 Marks Each	1, 2, 3	Any 2 questions are to be answered
II	3 Questions to be set of 20 Marks Each	4,5,6	Any 2 questions are to be answered
III	2 Questions to be set of 20 Marks Each	7,8	Any 1 question is to be answered

Mini Project -1

20ECAP801

Course Code: **20ECAP801**

Course Title: **Mini Project-1**

L-T-P: **0-0-3**

Credits: **3**

Contact Hrs: **6**

ISA Marks: **100**

ESA Marks: **100**

Total Marks: **200**

Teaching Hrs: **72 approx.**

Exam Duration: **3 Hours**

Students can use the following tools in web and mobile applications as well as product developments:

- Struts, Spring, Hibernate and JPA
- Machine Learning & Deep Learning
- JAXB and Apache Axis 2/Java
- JSP, Servlets, JDBC, EJB, JMS, JTA and JUnit
- Apache Tomcat, JBoss and GlassFish
- JavaScript, JSF, GWT and jQuery
- Eclipse, Netbeans and JBoss tools
- TestNG
- jBPM and Drools
- JCR

Objectives:

Help students to utilize and strengthen the knowledge of java which they have learnt in previous semester.

Methodology:

Students are asked to make a team of 3-4 members and can choose the different categories of projects like desktop applications, web applications, mobile application and distributed application and work once it is approved by the coordinator.

Assessment:

Students Assessment through CIE (80%) + SEE (20%)

Continuous Internal Evaluation	Assessment		Marks
	Problem Definition, Literature Review		10
	Synopsis and SRS Deliverables		10
	Design (Module wise algorithmic design)		20
	Coding		10



1.1.3 & 1.2.1 MCA courses having focus on employability/ entrepreneurship/ skill development offered by the University during the year July 2021 to June 2022.

	Integration and testing	10
	Report	10
	Presentation skills and Viva-voce	10
	Total	80
Semester End Examination	Presentation	10
	Viva-voce	10
	Total	100

1.1 Course Objectives:

The Mini Project being part of the course work is not only a mechanism to demonstrate the abilities and specialization but also provides the opportunity to demonstrate originality, teamwork, inspiration, planning and organization in a software project. One can put into practice the techniques that have been taught throughout the previous courses. Mini-projects develop practical skills in students. The idea is to propose a problem that one might encounter in future career (be it in academia, industry, or government). Then propose a solution and implement it.

E-commerce Objectives:

Most business houses are shifting their operations to the online world. Right from buying apparels to computers to booking tickets and renting out apartments, everything can be done through the Internet now. It is a win-win formula for both the customers and the business houses. Digital India aims to boost E-business and the E-commerce industry with the vision that it would in turn boost the economy as a whole.

Multilingual Objectives:

Language is an essential driver of enterprise growth. The user interface is the key component of any application that needs to support various language speaking audiences. Making an app that appeals to and is available for more users broadens the market and brings more revenue in the app sales and there will be more exposure to the business.

Evaluation:

- The project assessment is done by an evaluation team as per the schedule.

Guidelines for In Semester Assessment (ISA) Scheme

Phase wise distribution of marks	Marks
Identification and defining the problem	15
Software Requirement Specification	20
Software Design	15
Mid-way Implementation	10
Final Demo and Report Submission	20
Total	80

End Semester Assessment (ESA):



1.1.3 & 1.2.1 MCA courses having focus on employability/ entrepreneurship/ skill development offered by the University during the year July 2021 to June 2022.

There will be a final presentation /demonstration//viva-voce at the end of the semester for 20 Marks

Machine Learning

20ECAE803

Course Code: **20ECAE803**

Course Title: **Machine Learning**

L-T-P: **3-0-1**

Credits: **4**

Contact Hrs: **5**

ISA Marks: **50**

ESA Marks: **50**

Total Marks: **100**

Teaching Hrs: **40+24**

Exam Duration: **3Hrs**

No	Content	Hrs
Unit I		
1	Chapter 1 : Introduction to machine learning Introduction to Machine Learning, Applications of Machine Learning, Types of Machine Learning: Supervised, Unsupervised and Reinforcement learning, Dataset formats, Features and observations.	6 Hrs
2	Chapter 2 : Supervised Learning: Linear Regression, Logistic Regression Linear Regression, Logistic Regression: Single and Multiple variables, Sum of squares error function, The Gradient descent algorithm: Application, The cost function, Classification using logistic regression, one-vs-all classification using logistic regression, Regularization.	10 Hrs
Unit II		
3	Chapter 3 : Supervised Learning: Neural Network Introduction to Neural Network, Model representation, Gradient checking, Back propagation algorithm, Multi-class classification, Support vector machines, Applications & Use-cases.	8 Hrs
4	Chapter 4 : Unsupervised Learning: Clustering and Dimensionality Reduction Introduction to Clustering, K means Clustering Algorithm, Cost function, Application, Dimensionality reduction, PCA- Principal Component Analysis Applications, Clustering data and PCA.	8 Hrs
Unit III		
5	Chapter 5 : Introduction to Deep Learning What is deep learning? Difference between machine learning and deep learning, Convolution Neural Networks (CNN), Recurrent Neural Networks (RNN), When to use deep learning?	8 Hrs

Text Book:

1. Tom Mitchell., Machine Learning, Mc Graw Hill, McGraw-Hill Science, 3rd edition.
2. Christopher Bishop, Pattern Recognition and Machine Learning, Springer, 2007

References:

1. Hands-On Machine Learning with Scikit-Learn and Tensor Flow, Concepts, Tools, and Techniques to Build Intelligent Systems, Aurelian Gerona, Publisher: O'Reilly Media, July 2016.
2. Advanced Machine Learning with Python Paperback, 28 Jul 2016 by John Hearty.

Tools/Libraries:

- Python
 - Numpy, Scipy
 - Tensor flow / Theano / Keras



1.1.3 & 1.2.1 MCA courses having focus on employability/ entrepreneurship/ skill development offered by the University during the year July 2021 to June 2022.

- Sklearn.

Activities

#	TOPICS	ACTIVITY	WEIGHTAGE
1	Introduction to Machine Learning	Importing the libraries, dataset. Missing data, encoding categorical data, independent variable & dependent variable. Splitting the dataset into train, validation & test sets. Feature scaling.	10
		QUIZ	
2	Supervised Learning: Linear Regression	Simple Linear Regression – Predict the salary of employees given their years of experience.	10
		QUIZ	
3	Supervised Learning: Linear Regression	Multiple Linear Regression – Predict the profit to be gained by the investors of companies depending upon the expenses done for R&D Spend, Administration & Marketing Spend.	10
		QUIZ	
4	Supervised Learning: Logistic Regression	Logistic Regression – For the given Social Network data of customers, classify them as likely to purchase an item or not likely to purchase an item by analysing their age and estimated salary.	10
		QUIZ	
5	Supervised Learning: Neural Network	Neural Networks (Supervised Learning) – Apply SVM algorithm analyse a given customer data to categorise them as Probable & Improbable customers for an online web store.	10
		QUIZ	
6	Supervised Learning: Neural Network	Neural Networks (Supervised Learning) – For a given Bank Customer dataset with various features like Age, Income, Geography, Credit Rating, Products Bought so on, apply SVM to classify the customers as Exited or Not-Exited from the bank. Illustrate Backpropagation algorithm to minimize the classifier error.	15
		QUIZ	
7	Unsupervised Learning: Clustering	Clustering (Unsupervised Learning) – Apply K-Means algorithm for clustering the mall customers depending on their age, gender, income & spending score.	15
		QUIZ	
8	Unsupervised Learning:	Dimensionality Reduction (Unsupervised Learning) – For a given Wine dataset illustrate PCA to get 2 or 3 Principal Components among the 14 given features.	05



1.1.3 & 1.2.1 MCA courses having focus on employability/ entrepreneurship/ skill development offered by the University during the year July 2021 to June 2022.

	Dimensionality Reduction	QUIZ	
9	Introduction to Deep Learning	CNN (Deep Learning) – Using CNN develop a classifier to classify flowers in a Flower Image dataset.	10
		QUIZ	
10	Introduction to Deep Learning – RNN.	QUIZ	05
TOTAL			100

Evaluation Scheme

1. In Semester Assessment (ISA)

Assessment	Marks
ISA- 1	15
ISA- 2	15
Activities	20
ISA	50
ESA	50
Total	100

2. End Semester Assessment (ESA)

UNIT	8 Questions to be set of 20 Marks Each	Chapter Nos.	Instructions
I	3 Questions to be set of 20 Marks Each	1, 2	Any 2 questions are to be answered
II	3 Questions to be set of 20 Marks Each	3, 4	Any 2 questions are to be answered
III	2 Questions to be set of 20 Marks Each	5	Any 1 question is to be answered

Full Stack Development MEAN

20ECAE807

Course Code: **20ECAE807**

Course Title: **Full Stack Development - MEAN**

L-T-P: **3-0-1**

Credits: **4**

Contact Hrs: **5**

ISA Marks: **50**

ESA Marks: **50**

Total Marks: **100**

Teaching Hrs: 42

Exam Duration: **3 Hrs**

No

Content

Hrs

Unit I

1 Chapter 1 : Introduction to MEAN

05hrs

Three-tier web application development, The evolution of JavaScript, Introducing



1.1.3 & 1.2.1 MCA courses having focus on employability/ entrepreneurship/ skill development offered by the University during the year July 2021 to June 2022.

MEAN, Installing MongoDB, Installing Node.js, Introducing NPM.

- | | |
|--|-------|
| 2 Chapter 2 : Getting Started with Node.js | 05hrs |
| Introduction to Node.js, JavaScript closures, Node modules, Developing Node.js web applications. | |
| 3 Chapter 3 : Building an Express Web Application | 06hrs |
| Introduction to Express, Installing Express, Creating your first Express application, The application, request, and response objects, External middleware, Implementing the MVC pattern, Configuring an Express application, Rendering views, Serving static files, Configuring sessions. | |
| Unit II | |
| 4 Chapter 4 : Introduction to MongoDB | 05hrs |
| Introduction to NoSQL, Introducing MongoDB, Key features of MongoDB, MongoDB shell, MongoDB databases, MongoDB collections, MongoDB CRUD operations . | |
| 5 Chapter 5 : Introduction to Mongoose | 06hrs |
| Introducing Mongoose, Understanding Mongoose schemas, Extending your Mongoose schema, Defining custom model methods, Model validation, Using Mongoose middleware, Using Mongoose DBRef. | |
| 6 Chapter 6 : Managing User Authentication Using Passport | 06hrs |
| Introducing Passport, Understanding Passport strategies, Understanding Passport OAuth strategies; Introduction to AngularJS:- Introducing AngularJS, Key concepts of AngularJS, Installing AngularJS, Structuring an AngularJS application, Bootstrapping your AngularJS application, AngularJS MVC entities | |
| Unit – III | |
| 7 Chapter 7: Creating a MEAN CRUD Module | 04hrs |
| Introducing CRUD modules, Setting up the Express components, Introducing the ngResource module, Implementing the AngularJS MVC module, Finalizing your module implementation | |
| 8 Chapter 8: Testing MEAN Applications | 05hrs |
| Introducing JavaScript testing, Testing your Express application, Testing your AngularJS application; Adding Real-time Functionality Using Socket.io:- Introducing WebSockets, Building a Socket.io chat. | |

Text Book:

1. Amos Q, Haviv, *Mean Web Development*, Packt Publishing 2014.

References:

1. Colin J. Idrig, *Full Stack Javascript Development with MEAN*, Sitepoint



1.1.3 & 1.2.1 MCA courses having focus on employability/ entrepreneurship/ skill development offered by the University during the year July 2021 to June 2022.

Activities

Evaluation Scheme

1. In Semester Assessment (ISA)

Assessment	Marks
ISA- 1	15
ISA- 2	15
Activities	20
ISA	50
ESA	50
Total	100

2. End Semester Assessment (ESA)

UNIT	8 Questions to be set of 20 Marks Each	Chapter Nos.	Instructions
I	3 Questions to be set of 20 Marks Each	1, 2, 3	Any 2 questions are to be answered
II	3 Questions to be set of 20 Marks Each	4,5	Any 2 questions are to be answered
III	2 Questions to be set of 20 Marks Each	6,7	Any 1 question is to be answered

#	TOPICS	ACTIVITY	WEIGH TAGE
1	Introduction to MEAN	<ol style="list-style-type: none"> 1. Installation of MongoDB and Node.JS on Windows/Linux Platform. 2. Execute Node.JS program for the following <ol style="list-style-type: none"> a) Start of the Node.JS Server. b) Ensure Request/Response of the web application for login form. 3. Installation of NPM/Yarn package manager. 4. Execute Node.JS program using node packages. 5. Demonstration of "package.json" and its features. 	10
2	Getting Started with Node.js	<ol style="list-style-type: none"> 1. Program to compare JavaScript functions and Clouse functions. 2. Program to implement JavaScript closure for user registration and login use cases. 3. Developing calculator web application using Node.JS and its modules. 	10
3	Building an Express Web Application	<ol style="list-style-type: none"> 1) Installation of ExpressJS package for the project. 2) Program to ensure ExpressJS server is up and running on the specified port. 3) Developing an ExpressJS application for currency conversion use case to understand Request/Response of the objects. 	15



1.1.3 & 1.2.1 MCA courses having focus on employability/ entrepreneurship/ skill development offered by the University during the year July 2021 to June 2022.

		<ol style="list-style-type: none"> 4) Implement the following for currency conversion use case: <ol style="list-style-type: none"> a) Program to create a module. b) Program the export the modules. c) Program to import the modules. 5) Demonstrate ExpressJS template features for rendering the content of the web application. 6) Develop an media player application for static media content. 		
4	Introduction to MongoDB	<ol style="list-style-type: none"> 1) Creating MongoDB database using MongoDB CLI. 2) Demonstrate the Robo-Mongo Tool features for MongoDB access. 3) Execute the following MongoDB queries for College Database: <ol style="list-style-type: none"> a) Creation of required collection for college database. b) Insertion of records for the created collection. c) Executing the basic queries with different filter criteria's. d) Executing different aggregate queries. e) Sharding and Replication of MongoDB instance. 4) Demonstration of MongoDB cluster and its features. 	15	
5	Introduction to Mongoose	<ol style="list-style-type: none"> 1) Installation of Mongoose and its dependency packages. 2) Program to create MongoDB schema with different attributes using Mongoose. 3) Implementation of supported mongoose model field validations. 4) Implementation of custom model methods for mongoose schema. 5) Program for Foreign Key reference using mongoose DBRef functionality. 	15	
6	Managing User Authentication Using Passport Creating a MEAN CRUD Module	<ol style="list-style-type: none"> 1) Installation of passport and its dependency packages. 2) Program to implement local and OAuth passport strategies. 3) Implementation of OAuth for google and facebook authentication. 4) Installation of AngularJS and its dependency packages. 5) Program for form validation using AngularJS. 6) Implement CRUD operations for few of the modules of E-Commerce web applications using AngularJS, ExpressJS and MongoDB. 	20	
7	Testing MEAN Applications	<ol style="list-style-type: none"> 1) Installation of karma, mocha and jasmine its dependency packages. 2) Program to implement unit testing using karma and mochaTest. 3) Program to implement unit testing using karma and JasmineTest. 4) Demonstrate unit testing reports using karma-html-reporter. 	15	



1.1.3 & 1.2.1 MCA courses having focus on employability/ entrepreneurship/ skill development offered by the University during the year July 2021 to June 2022.

	5) Visualize the code coverage analysis using karma. 6) Installing Socket.io and its dependency packages. 7) Building an Chat application using Socket.io		
	Total	100	

Certification (RPA)		20ECAP802	
Course Code: 20ECAP802	Course Title: Certification (Robotics Process Automation)		
L-T-P: 0-0-2	Credits: 2	Contact Hrs: Full Time	
ISA Marks: 100	ESA Marks: --	Total Marks: 100	
Teaching Hrs: Full Time	Exam Duration: 3 Hours		
<p>The students shall undergo certification on Robotics Process Automation (RPA) during the II or III semester vacation by choosing Automation Anywhere or UiPath course or both. The evaluation for the course shall be done after successful completion of certification on any one or both by III semester. The student has to submit the report along with certificates. The performance of this course will be reflected in IV semester grade cards.</p>			

Capstone Project Work		20ECAP803	
Course Code: 20ECAP803	Course Title: Capstone Project Work		
L-T-P: 0-0-12	Credits: 12	Contact Hrs: Full Time	
ISA Marks: 100	ESA Marks: 150	Total Marks: 250	
Teaching Hrs: Full Time	Exam Duration: 3 Hours		
<p>A student must carry out a project on any domain using cutting edge technologies and demonstrates the same at the end of the semester.</p>			

Evaluation:

Students Assessment through ISA (100 Marks) + ESA (150 Marks)

In Semester Assessment (100 Marks)	Assessment	Weight in Marks
		Periodic reviews by Committee and Guide
End Semester Assessment (150 Marks)	Final Review	15



1.1.3 & 1.2.1 MCA courses having focus on employability/ entrepreneurship/ skill development offered by the University during the year July 2021 to June 2022.

Total

250

* ISA Rubrics will be intimated in the 1st week of CoE.

Evaluation:

In Semester Assessment (ISA): 100 Marks

Phase wise distribution of marks	
Project Proposal, Synopsis Presentation	50
SRS and Design	50
Mid-Way Implementation	50
Final Demo and Report Submission	50
Total	200 (Scaled down to 100)

1. Semester End Examination (SEE): 150 Marks (Dissertation 100+ Viva-Voce 50)

Dissertation: 100 Marks		
Sl. No.	Parameters to check	Marks
1	Requirements document quality (Identification of all requirements /Use cases)	30
2	Detailed Design and Implementation (DFD, algorithm/flowchart, ER Diagram, Data structure)	60
3	Test Plan	10
Total		100

Viva-Voce: 50 Marks Which includes Write-Up and Project Demonstration

Write-Up 50 Marks + Demonstration 50 Marks

Total 100 Marks (Scaled down to 50 Marks)

Write-Up 50 Marks		
Sl. No.	Parameters to check	Marks
1	Brief Problem definition (clarity)	10
2	Block diagram representation of the solution/Design (Architectural Design)	20
3	Applications	10
4	Limitations	10
Total		50



1.1.3 & 1.2.1 MCA courses having focus on employability/ entrepreneurship/ skill development offered by the University during the year July 2021 to June 2022.

Demonstration 50 Marks		
Sl. No.	Parameters to check	Marks
1	Implementation of the project as per the stated objectives.	15
2	User Interface quality.	5
3	Code quality (Coding standards, modularity, Documentation)	10
4	Testing.	5
5	Individual Contribution.	5
6	Rating of the project by (external examiner).	5
7	Explanation of the code and modification if necessary (external examiner).	5
Total		50

Phase Wise Activities

Activity	Purpose / Objective	Deliverables	Schedule
Awareness (By Coordinator)	<ul style="list-style-type: none"> To instruct about the course expectations and assessment rubrics. 	-	Before Semester Commences
Identification and defining the problem and Software Requirement Specification (By Student)	<ul style="list-style-type: none"> To identify a problem which includes innovation element? Identify at least 3 constraints of the solution. To explore one alternate approaches to solution for the identified problem. Identify functional requirements and Nonfunctional requirements(if exist) Test plan for Acceptance testing. effort estimation. 	<p>One page description of problem abstraction with at least five product features for the identified problem.</p> <p>Software requirement document</p>	Demo 1



1.1.3 & 1.2.1 MCA courses having focus on employability/ entrepreneurship/ skill development offered by the University during the year July 2021 to June 2022.

Software Design (by Student)	<ul style="list-style-type: none"> ○ prepare suitable design for the whole system(Architecture , Data flow diagram, Class diagram, activity diagram) 	Software Design Document (SDD)	Demo 2
Mid-way Implementation (By student)	<ul style="list-style-type: none"> ○ 50-60% work should be completed incorporating programming standards(documentation, modular approach) ○ Module testing. 	Partial Source code	Demo 3
Final Demo and Report Submission	<ul style="list-style-type: none"> ○ Completion of the project as per the Problem definition ○ Evaluation of Report by Faculty in Charge 	Report Final demo	Final Demo

Deep Learning		20ECAE809	
Course Code: 20ECAE809		Course Title: Deep Learning	
L-T-P: 3-0-0		Credits: 3	Contact Hrs: 3
ISA Marks: 100		ESA Marks: --	Total Marks: 100
Teaching Hrs: 40 + 24		Exam Duration: 3Hrs	
No	Content	Hrs	
Unit I			
1	Chapter 1 : Deep Learning Intuition Introduction to deep learning, Neural Network Basics, Batch Normalization in Neural Networks.	3 Hrs	
2	Chapter 2 : Adversarial Examples and Generative Adversarial Networks Attacking neural networks with Adversarial Examples and Generative Adversarial Networks, Shallow Neural Network, Key concepts on Deep Neural Networks, Building your Deep Neural Network: step by step, Deep Neural Network – Application. Explaining and Harnessing Adversarial Examples, Generative Adversarial Nets, Conditional GAN, Super-Resolution GAN, CycleGAN.	7 Hrs	
3	Chapter 3 : Improving Deep Neural Networks: Hyperparameter tuning, Regularization and Optimization Practical aspects of deep learning, Optimization algorithms, Initialization, Regularization, Gradient Checking, Optimization, Hyperparameter tuning, Batch Normalization, Programming Frameworks.	6 Hrs	
Unit II			
4	Chapter 4 : Convolutional Neural Networks A guide to convolution for deep learning, The basics of ConvNets, Deep	8 Hrs	



1.1.3 & 1.2.1 MCA courses having focus on employability/ entrepreneurship/ skill development offered by the University during the year July 2021 to June 2022.

convolutional models, **Visualizing and Understanding Convolutional Networks, Deep Inside Convolutional Networks: Visualizing Image Classification Models, Understanding Neural Networks Through Deep Visualization.**

- Convolutional Model: application
- Keras Tutorial
- Residual Networks.

5 Chapter 5 : Interpretability of Neural Networks

8 Hrs

Detection Algorithms, Special Applications: Face Recognition & Neural Style Transfer, Dropout: A Simple Way to Prevent Neural Networks from Overfitting, DenseNet: Densely Connected Convolutional Networks.

Unit III

6 Chapter 6 : Recurrent Neural Networks : Deep Reinforcement Learning

8 Hrs

Introduction to Recurrent Neural Network, Building a Recurrent Neural Network - Step by Step

- Character-level Language Modeling
- LSTM
- Natural Language Processing and Word Embeddings
- Sequence Models and Attention Mechanism
- Operations on Word Vectors - Debiasing
- Emojify!
- Neural Machine Translation with Attention
- Trigger Word Detection

References:

3. Deep Learning, By Ian Goodfellow, Yoshua Bengio and Aaron Courville.
4. Deep Learning Tutorial, By LISA Lab, University of Montreal.
5. Deep Learning: Methods and Applications, By Li Deng and Dong Yu.
6. First Contact with TensorFlow, get started with Deep Learning Programming, By Jordi Torres.
7. Neural Networks and Deep Learning, By Michael Nielsen.
8. Advanced Machine Learning with Python Paperback, 28 Jul 2016 by John Hearty.

Tools/Libraries:

- Python
 - Numpy, Pandas, Scipy
 - Tensor flow / Theano / Keras
 - Sklearn.

Activities

#	TOPICS	ACTIVITY	WEIGHTAGE
1	Deep Learning Intuition	<ul style="list-style-type: none"> • Python Basics with Numpy (Optional) • Implementation of Logistic Regression with a neural network mindset. 	10



1.1.3 & 1.2.1 MCA courses having focus on employability/ entrepreneurship/ skill development offered by the University during the year July 2021 to June 2022.

2	Adversarial Examples and Generative Adversarial Networks	<ul style="list-style-type: none"> Building Shallow Neural Networks Planar data classification with a hidden layer 	20
3	Improving Deep Neural Networks: Hyperparameter tuning, Regularization and Optimization	<ul style="list-style-type: none"> Working with Optimization Algorithms – Initialization, Regularization, Gradient Checking, Optimization Working with Hyperparameter tuning & Batch Normalization. Bird recognition in the city of Peacetopia (case study) Autonomous driving (case study) Tensorflow Tutorial 	25
4	Convolutional Neural Networks & Interpretability of Neural Networks	<ul style="list-style-type: none"> Building Convolutional Model: step by step Keras Tutorial. Working with Residual Networks Working on Face Recognition & Neural Style Transfer Car Detection with YOLO – Case Study 	25
5	Recurrent Neural Networks : Deep Reinforcement Learning	<ul style="list-style-type: none"> Building a Recurrent Neural Network - Step by Step Dinosaur Land -- Character-level Language Modeling Jazz improvisation with LSTM Operations on Word Vectors - Debiasing Neural Machine Translation with Attention Trigger Word Detection 	20
TOTAL			100

Evaluation Scheme

1. In Semester Assessment (ISA)

Assessment	Marks
ISA- 1	15
ISA- 2	15
Activities	20
ISA	50
ESA	50



1.1.3 & 1.2.1 MCA courses having focus on employability/ entrepreneurship/ skill development offered by the University during the year July 2021 to June 2022.

Total

100

2. End Semester Assessment (ESA)

UNIT	8 Questions to be set of 20 Marks Each	Chapter Nos.	Instructions
I	3 Questions to be set of 20 Marks Each	1, 2	Any 2 questions are to be answered
II	3 Questions to be set of 20 Marks Each	3, 4	Any 2 questions are to be answered
III	2 Questions to be set of 20 Marks Each	5	Any 1 question is to be answered

Blockchain Technologies

20ECAE810

Course Code: **20ECAE810**

Course Title: **Blockchain Technologies**

L-T-P: **3-0-0**

Credits: **3**

Contact Hrs: **3**

ISA Marks: **100**

ESA Marks: -

Total Marks: **100**

Teaching Hrs: **40+24**

Exam Duration: **3Hrs**

No	Content Unit I	Hrs
1	Introduction What blockchain is, What blockchain isn't, Blockchain definitions, How are blockchains different from databases? History of blockchain, Blockchain 2.0, The motivations behind blockchain, Characteristics of blockchain, Background of DLT, The different types of blockchain, Overview of blocks, Influence of Moore's law on blockchain technology.	5 hrs
2	A Bit of Cryptography. Cryptography in blockchain, Classical cryptography, Cryptographic primitives, Symmetric key cryptography, Asymmetric key cryptography, Elliptic-curve cryptography, Digital signatures, Cryptographic hashing.	5 hrs
3	Cryptography in Blockchain Hashing in blockchain, Linking blocks in a blockchain, Linking blocks using an SHA256 hashing algorithm, Block structure, Blockchain functionality, Creating a blockchain, Byzantine failure problem in blockchain, Digital signatures in blockchain, Creating an identity, Signatures in transaction, Asset ownership in blockchain, Transferring an asset, Transmitting the transaction, Claiming the asset, Blockchain wallets.	6 hrs
Unit - 2		
4	Networking in Blockchain. Peer-to-peer (P2P) networking, Network discovery, Block synchronization, Building a simple blockchain in a P2P network, Validating a new block, Selecting the longest chain, Conflict resolution, Block exchange between peers, Initial block synchronization, Broadcasting scenarios, Application interfaces.	6 hrs
5	Cryptocurrency. Bitcoin basics, Getting started with Bitcoin Core, Keys and addresses, Transactions, Mining and consensus, Blockchain, Blockchain networks, Bitcoin hard forks and altcoins, A simple cryptocurrency application: Transactions, Wallet, Transaction management.	5 hrs
6	Diving into Blockchain - Proof of Existence. MultiChain blockchain platform, Setting up a blockchain environment, Getting started with MultiChain, Proof of Existence architecture, Building the Proof of	5 hrs



1.1.3 & 1.2.1 MCA courses having focus on employability/ entrepreneurship/ skill development offered by the University during the year July 2021 to June 2022.

Existence application, Executing and deploying the application.

Unit - 3

- | | | |
|----------|--|-------|
| 7 | Diving into Blockchain - Proof of Ownership.
Digital assets and identity, Proof of ownership, Smart contracts, Choosing the smart contract platform, NEO blockchain: Building blocks of a NEO blockchain, NEO technology, NEO nodes, NEO network, NEO transactions, Ethereum blockchain: Ethereum nodes, Getting started, Creating a decentralized application. | 4 hrs |
| 8 | Blockchain Security.
Transaction security model, Decentralized security model, Attacks on the blockchain, Threats of quantum computing. | 4 hrs |

Text Book:

1. Foundations of Blockchain, O'REILLY publications, 2019

References:

Evaluation Scheme

In Semester Assessment (ISA)

Assessment	Marks
ISA- 1	10
ISA- 2	10
Activities	30
ISA	50
ESA	50
Total	100

End Semester Assessment (ESA)

UNIT	8 Questions to be set of 20 Marks Each	Chapter Nos.	Instructions
I	3 Questions to be set of 20 Marks Each	1, 2, 3,	Any 2 questions are to be answered
II	3 Questions to be set of 20 Marks Each	4, 5, 6	Any 2 questions are to be answered
III	2 Questions to be set of 20 Marks Each	7, 8	Any 1 question is to be answered

Practices

1. Implementation of basic cryptographic algorithms such as AES, ECC, RSA, ECDSA, SHA256.
2. Implementation of cryptographic primitives such as hash functions and digital signatures.
3. Implementation of P2P blockchain application.
4. Implementation of Interface for the cryptocurrency application such as wallet application and explorer application.
5. Implement decentralized application development using MultiChain blockchain framework by considering real time use case.
6. Develop decentralized application using smart contract concept in NEO and Ethereum blockchain platforms by considering real time use case.



1.1.3 & 1.2.1 MCA courses having focus on employability/ entrepreneurship/ skill development offered by the University during the year July 2021 to June 2022.

7. Simulation of double spend attack on the Bitcoin unconfirmed transaction.

Mobile Application Development

20ECAE811

Course Code: **20ECAE811**

Course Title: **Mobile Application Development**

L-T-P: **3-0-0**

Credits: **3**

Contact Hrs: **3**

ISA Marks: 100

ESA Marks: -

Total Marks: **100**

Teaching Hrs: **40+24**

Exam Duration: **3Hrs**

No	Content	Hrs
Unit I		
1	Mobility and Android Introduction, Mobility Panorama, Mobile Platforms, App Development Approaches, Android Overview.	2 Hrs
2	Getting Started with Android Introduction, Setting up Development Environment, Saying Hello to Android, Traversing an Android App, Project Structure, Logical Components of an Android App, Android Tool Repository, Installing and Running App Devices.	2 Hrs
3	Learning with an Application Introduction, 3CheersCable App, Mobile App Development, Challenges, Tenets of a Winning App.	3 Hrs
4	App User Interface Introduction, Activity, UI Resources, UI Elements and Events, Interaction among Activities, Fragments, Action Bar and Applications.	5 Hrs
5	App Functionality - Beyond UI Introduction, Threads, AsyncTask, Service, Notifications, Intents and Intent Resolution, Broadcast Receivers, Telephony and SMS- Their Application.	4 Hrs
Unit - 2		
6	App Data - Persistence and Access Introduction, Flat Files, Shared Preferences, Relational Data, Data Sharing Across Apps, Enterprise Data.	4 Hrs
7	Graphics and Animation Introduction, Android Graphics, Android Animation.	4 Hrs
8	Multimedia Introduction, Audio, Video and Images, Playback, Capture and Storage.	4 Hrs
9	Location Services and Maps Introduction, Google Play Services, Location Services, Maps	4 Hrs
Unit - 3		
10	Sensors Introduction, Sensors in Android, Android Sensor Framework, Motion Sensors, Position Sensors, Environment Sensors	3 hrs
11	Testing Android Apps Introduction, Testing Android App Components, App Testing Landscape Overview Publishing Apps: Introduction, Groundwork, Configuring, Packaging, Distributing.	3 hrs
12	Chapter No. 12. Publishing Apps Introduction, Groundwork, Configuring, Packaging, Distributing.	2 hrs



1.1.3 & 1.2.1 MCA courses having focus on employability/ entrepreneurship/ skill development offered by the University during the year July 2021 to June 2022.

Text Book:

1. AnubhavPradhan, Anil V Deshpande, Composing Mobile Apps using Android, 2014, Wiley, 2014

References:

1. Barry Burd, Android Application Development All in one for Dummies.
2. Ian F Darwin, Android Cookbook.
3. Frank Ableson, RobiSen, Chris King, C. Enrique Ortiz, Android in Action, Manning Publications.

Evaluation Scheme

In Semester Assessment (ISA)

Assessment	Marks
ISA- 1	10
ISA- 2	10
Activities	30
ISA	50
ESA	50
Total	100

End Semester Assessment (ESA)

UNIT	8 Questions to be set of 20 Marks Each	Chapter Nos.	Instructions
I	3 Questions to be set of 20 Marks Each	1, 2, 3, 4, 5	Any 2 questions are to be answered
II	3 Questions to be set of 20 Marks Each	6, 7, 8, 9	Any 2 questions are to be answered
III	2 Questions to be set of 20 Marks Each	10, 11, 12	Any 1 question is to be answered

Mobile Application Development Practice Exercises

SI NO Topics

1. Designing of Layouts using android UI resources.
2. Working on Intents with multiple Activities.
3. Working on Fragments and Action Bars related features.
4. Implementation of Threading concepts using Thread and Runnable Classes.
5. Working on the functionalities of Android services.
6. Working on Persistence storages.
7. Working on Graphics, Animation and multimedia features
8. Implementation of device built in Sensor functionalities.
9. Working on Location Services and Maps



1.1.3 & 1.2.1 MCA courses having focus on employability/ entrepreneurship/ skill development offered by the University during the year July 2021 to June 2022.

Cyber Security & Forensics		20ECAE812
Course Code: 20ECAE812	Course Title: Cyber Security & Forensics	
L-T-P: 3-0-0	Credits: 3	Contact Hrs: 3
ISA Marks: 100	ESA Marks: -	Total Marks: 100
Teaching Hrs: 40+24		Exam Duration: 3Hrs
No	Content	Hrs
	Unit I	
1	Chapter 1: Introduction to Cybercrime, Cyber offences & Cybercrime Cybercrime definition and origins of the word, Cybercrime and information security, Classifications of cybercrime, A global Perspective on cybercrimes. Cyber-attack plans, Social Engineering, Cyberstalking, Cybercafe and Cybercrimes, Botnets, Proliferation of Mobile and Wireless Devices, Credit Card Frauds in Mobile and Wireless Computing Era. Security challenges posed by mobile devices.	8 Hrs
2	Chapter 2: Tools and Methods used in Cybercrime, Phishing and identity theft Proxy servers, Phishing, Password cracking, key loggers and spyware, Virus and worms, Trojan horses and backdoors, steganography, DoS and DDoS, SQL Injection, Buffer Overflow, Attack on wireless Networks, Phishing and Identity theft.	8 Hrs
	Unit II	
3	Chapter 3: Cybercrimes and Cybersecurity: The Legal Perspectives, Organizational implications. Cybercrime and the legal landscape around world, Why do we need Cyberlaw: The Indian Context, The Indian IT Act, Digital Signature and the Indian IT Act, Amendments to the Indian IT Act, Cybercrime and Punishment, Cost of cybercrime and IPR issues, Web threats for organization, cloud computing threats; security and privacy implications, social computing issues; Guidelines for internet usage and safe computing; incident handling	8 Hrs
4	Chapter 4: Understanding computer Forensics, Forensics of Hand-held devices Historical background of forensics; Digital forensics science; need for computer forensics; cyber forensics and digital evidence; Analysis E-mail; Digital forensics life cycle; chain of custody concepts; network forensics; Forensics and social networking; challenges in computer forensics; Hand-held devices and digital forensics; Toolkits for Hand-held device forensics; Techno-legal challenges form hand-held devices; Guidelines8	8 Hrs
	Unit – III	
5	Chapter 5: Social, Political, Ethical and Psychological Dimensions Intellectual property in the cyberspace; Ethical dimension of cybercrimes; Psychology, mindset and skills of hackers and other cyber criminals; Sociology of cybercriminals.	4 Hrs
6	Chapter 6: Cybercrime: Illustrations, Examples and Case studies Introduction, Real-Life Examples, Case Studies: Illustrations of Financial Frauds in Cyber Domain, Digital Signature-Related Crime Scenarios, Digital forensics case illustrations Online Scams.	4 Hrs



1.1.3 & 1.2.1 MCA courses having focus on employability/ entrepreneurship/ skill development offered by the University during the year July 2021 to June 2022.

Text Book (List of books as mentioned in the approved syllabus)

1. Nina Godbole & Sunit Belapur, "Cyber Security", Wiley India, 2011 and Reprint 2018.

References

1. Kevin Mandia, Chris Prorise, Matt Pepe, "Incident Response and Computer Forensics ", Tata McGraw -Hill, New Delhi, 2006.
2. Robert M Slade," Software Forensics", Tata McGraw - Hill, New Delhi, 2005.

Activities

#	TOPICS	ACTIVITY	WEIGHTAGE
1	Introduction to Cybercrime, Cyber offences & Cybercrime	<ul style="list-style-type: none"> • Exercise on hash functions and applications. • Message Authentication code • Symmetric and asymmetric algorithms. • Digital Signatures • Quantum shape Cryptology, Crypto libraries for developers • Detecting and protecting against Bitnets <p>https://www.akamai.com/us/en/resources/what-is-a-botnet.jsp</p> <p>https://cryptobook.nakov.com/cryptography-overview</p>	10
2	Tools and Methods used in Cybercrime, Phishing and identity theft	<ul style="list-style-type: none"> • Implementation of phishing simulator and identify the real time phishing scenario • Ethical hacking using Kali Linux and penetration testing • Exploration and practice of Kali Linux Tools • Aircrack-ng : Aircrack-ng is a suite of tools used to assess WiFi network security. • Nmap : Network Mapper, also commonly known as Nmap, is a free and open source utility for network discovery and security auditing. 	30



1.1.3 & 1.2.1 MCA courses having focus on employability/ entrepreneurship/ skill development offered by the University during the year July 2021 to June 2022.

		<ul style="list-style-type: none"> • THC Hydra : When you need to brute force crack a remote authentication service, Hydra is often the tool of choice. • Nessus: Nessus is a remote scanning tool that you can use to check computers for security vulnerabilities. • WireShark: WireShark is an open-source packet analyzer that you can use free of charge. • Categories of SQL Injections • Implementation of a steganography using various tools like: Stegosuite, Stegohide, Xiao Steganography, SSuite Picssel, OpenPuff Camouflage • https://stylesuxx.github.io/steganography/ • https://manytools.org/hacker-tools/steganography-encode-text-into-image/ • Identifying cross-site scripting vulnerabilities and prevention mechanisms • https://www.veracode.com/security 	
3	Cybercrimes and Cybersecurity: The Legal Perspectives, Organizational implications.	<ul style="list-style-type: none"> • Guidelines on implications of organization from the view point of cybercrime and cybersecurity 	10
4	Understanding computer Forensics, Forensics of Hand-held devices	<ul style="list-style-type: none"> • Parrot Security OS: Parrot Security operating system is a Debian-based Linux distribution built by Frozenbox Network for cloud oriented penetration testing. It is a comprehensive, 	20



1.1.3 & 1.2.1 MCA courses having focus on employability/ entrepreneurship/ skill development offered by the University during the year July 2021 to June 2022.

		<p>portable security lab that you can use for cloud pentesting, computer forensics, reverse engineering and hacking.</p> <ul style="list-style-type: none"> • WebGoat: The WebGoat, is a deliberately insecure web application, which is aimed at helping developers learn about security vulnerabilities. • Categories of SQL Injections and test vulnerabilities commonly found in java based applications. 	
5	Social, Political, Ethical and Psychological Dimensions	<p>Real world case studies on various scenarios and detailed discussion on the cybercrimes, applicable law and legal liabilities and modus operandi covered by the criminals. Example;</p> <ol style="list-style-type: none"> Orkut fake profile cases Email account hacking Credit Fraud Online share trading fraud Source code Theft Theft of confidential information Software/Music Piracy Phishing Cyber pornography Online sale of illegal articles <p>https://www.slideshare.net/shmecse13/case-study-on-cyber-crime</p>	15
6	Cybercrime: Illustrations, Examples and Case studies	<ul style="list-style-type: none"> • Analyzing e-mail header for the following using tools like WolframAlpha or Ipfingerprint • Determine the sender's geographic Location • Information about sender's IP address 	15
		Total	100



1.1.3 & 1.2.1 MCA courses having focus on employability/ entrepreneurship/ skill development offered by the University during the year July 2021 to June 2022.

Evaluation Scheme

1. In Semester Assessment (ISA)

Assessment	Marks
ISA- 1	10
ISA- 2	10
Activities	30
ISA	50
ESA	50
Total	100

2. End Semester Assessment (ESA)

UNIT	8 Questions to be set of 20 Marks Each	Chapter Nos.	Instructions
I	3 Questions to be set of 20 Marks Each	1, 2	Any 2 questions are to be answered
II	3 Questions to be set of 20 Marks Each	3,4	Any 2 questions are to be answered
III	2 Questions to be set of 20 Marks Each	5,6	Any 1 question is to be answered

Virtual Reality Systems

20ECAE814

Course Code: **20ECAE814**

Course Title: **Virtual Reality Systems**

L-T-P: **3-0-0**

Credits: 3

Contact Hrs: 3

ISA Marks: **100**

ESA Marks: --

Total Marks: **100**

Teaching Hrs: 40+24

Exam Duration:**3Hrs**

No	Content	Hrs
Unit I		
1	Chapter 1 : Virtual Reality and Virtual Environment and The Historical Development of VR Introduction, Computer graphics, Real-time computer graphics, Flight Simulation, Virtually environments, Virtually here, What is required?, The benefit of virtual reality, Historical Development of VR: Introduction, Scientific landmarks.	4 Hrs
2	Chapter 2: 3D Computer Graphics Introduction, The virtual world space, Positioning the virtual observer, The perspective projection, Human vision, Stereo perspective projection, 3D clipping, Color theory, Simple 3D modelling, Illumination models, Reflection models, Shading algorithms, Radiosity, Hidden-surface removal, Realism, Stereographic image	4 Hrs
3	Chapter 3: Geometric Modelling and Geometric Transformations Introduction, From 2D to 3D, 3D space curves, 3D boundary representation, Other Modelling Strategies, Frames of reference; Geometric Transformations: Introduction, Frames of reference, Modelling Transformations, Instances, Picking, Flying, Scaling the	4 Hrs



1.1.3 & 1.2.1 MCA courses having focus on employability/ entrepreneurship/ skill development offered by the University during the year July 2021 to June 2022.

VE, Collision Detection.

- 4 Chapter 4: A generic VR System 4 Hrs**
Introduction, The virtual environment, The computer Environment, VR technology, Modes of Interaction, VR systems.

Unit II

- 5 Chapter 5 : Interacting with the Virtual World 8 Hrs**
User Interface Metaphors-Key Interactions: Manipulation, Navigation, and Communication, Manipulating a Virtual World-Manipulation Methods, Properties of Manipulation, Selection, Manipulation Operations, Manipulation Summary, Navigating in a Virtual World-Wayfinding, Trave, Navigation Summary, Interacting with Others-Shared Experience Collaborative Interaction, Interacting with the VR System (Metacommands)

- 6 Chapter 6: The Virtual Reality Experience 8 Hrs**
Immersion-Physical/Sensory Immersion, Mental Immersion The Role of Realism in Immersion Point of View Venue, Rules of the Virtual World: Physics- Types of Virtual World Physics, User Interaction with the World Physics, Simulation/Mathematical Model, Object Co-Interaction, World Persistence, Interference from the Physics of the Real World, Substance of the Virtual World - World Geography, Objects, Agents, User Interface Elements

Unit – III

- 7 Chapter 7: Experience Design. Applying VR to a Problem 4 Hrs**
Will VR Meet Your Goals? - Is VR the Appropriate Medium?, Creating a VR Application - Adapting from Other Media, Adapting from an Existing VR Experience, Creating a New VR Experience, Designing a VR Experience- Design Deliberately, Design with the System in Mind, Design with the Venue in Mind, Design with the Audience in Mind, Consider Design Tradeoffs, Design the User Objective, Design the End of the Experience, Document, Deploy, and Evaluate the Experience, The Future of VR Design

- 8 Chapter 8: The Future of Virtual Reality 4 Hrs**
The State of VR - Technology Trigger, Peak of Inflated Expectations, Trough of Disillusionment, Slope of Enlightenment, Plateau of Productivity, The Field of VR Research, Trends, Technology Futures - Display Technologies, Input Technologies, Software - Hardware Interface Software, Application Development Software, Application Futures

Text Book:

1. John Vince, Virtual Reality Systems , Pearson, 2002
2. William R. Sherman, Alan B. Craig, Understanding Virtual Reality, Inteface, Application and Design, MORGAN KAUFMANN PUBLISHERS, 2003



1.1.3 & 1.2.1 MCA courses having focus on employability/ entrepreneurship/ skill development offered by the University during the year July 2021 to June 2022.

Activities

#	TOPICS	ACTIVITY	WEIGHTAGE
1	Getting Started	Demonstrate the following: <ul style="list-style-type: none"> • The Dashboard interface • Creating a new scene • The Sumerian editor interface 	10
2	Amazon Sumerian Basics: Create your first scene	Learn and accomplish the following: <ul style="list-style-type: none"> • Create a room with primitive entities (Box) • Cover lighting basics • Import entities from the asset library • Place and move objects • Create interactive behaviors using the State Machine • Add basic animations 	15
3	State Machine Basics	Build behaviors , using a collection of States that are connected by Transitions , as an entity transitions from one state to another.	15
4	Events Basics	Create a simple action to rotate a <i>Box</i> entity when we click a <i>Sphere</i> .	15

5	Timeline Basics	Animate a drone to fly around a large sphere using the Timeline and Keyframes . The Timeline enables you to create animations and movements for scene entities. You can also trigger them by actions you set in the State Machine .	15
6	Importing third Party Assets	Import asset bundles that consist of multiple files by dragging and dropping them onto the canvas. Using this capability, you can import .obj files, .mtl files, meshes, materials, and textures using a single drag and drop.	15
7	Material Fundamentals using the Classic Shader	Demonstrate the concepts of adding Textures and optimizing the Material component by working with sphere Primitives.	15
		Total	100

Evaluation Scheme

3. In Semester Assessment (ISA)



1.1.3 & 1.2.1 MCA courses having focus on employability/ entrepreneurship/ skill development offered by the University during the year July 2021 to June 2022.

Assessment	Marks
ISA- 1	10
ISA- 2	10
Activities	30
ISA	50
ESA	50
Total	100

4. End Semester Assessment (ESA)

UNIT	8 Questions to be set of 20 Marks Each	Chapter Nos.	Instructions
I	3 Questions to be set of 20 Marks Each	1, 2, 3,4	Any 2 questions are to be answered
II	3 Questions to be set of 20 Marks Each	5,6	Any 2 questions are to be answered
III	2 Questions to be set of 20 Marks Each	7,8	Any 1 question is to be answered



B.E. (Mechanical Engineering) 3rd and 4th Semester Curriculum Structure & Syllabus 2020 – 24 Batch



B.E. (Mechanical Engineering) Curriculum structure & Syllabus 2020 – 24 Batch

Semester: III

No	Code	Course	Category	L-T-P	Credits	Contact Hours	ISA	ESA	Total	Exam Duration
---	15EMAB231	Calculus & Integral Transforms (Diploma Students)	BS	4-0-0	4	4	50	50	100	3 hours
1	15EMAB201	Statistics and Integral Transforms								
2	15EMEF201	Mechanics of Materials	ES	3-1-0	4	5	50	50	100	3 hours
3	15EMEC201	Manufacturing Processes	PSC	4-0-0	4	4	50	50	100	3 hours
4	15EMEC202	Engineering Thermodynamics	PSC	3-0-0	3	3	50	50	100	3 hours
5	19EMEC201	Control Systems	PSC	2-1-0	3	4	50	50	100	3 hours
6	16EMEP201	Manufacturing Processes Lab	PSC	0-0-1	1	2	80	20	100	2 hours
7	19EMEP201	Control Systems Lab	PSC	0-0-2	2	4	80	20	100	2 hours
8	18EMEP203	Machine Drawing Lab	PSC	0-0-1	1	2	80	20	100	2 hours
TOTAL				16-2-4	22	28				

ISA: In Semester Assessment, **ESA:** End Semester Assessment, **L:** Lecture, **T:** Tutorials, **P:** Practical. **PSC:** Program Specific Core, **BS:** Basic Science, **ES:** Engineering Science,



B.E. (Mechanical Engineering) Curriculum structure & Syllabus 2020 – 24 Batch

Semester: IV

No	Code	Course	Category	L-T-P	Credits	Contact Hours	ISA	ESA	Total	Exam Duration
---	15EMAB241	Vector Calculus & Differential Equations (Diploma Students)	BS	4-0-0	4	4	50	50	100	3 hours
1	19EMAB206	Numerical Methods and Partial Differential Equations	BS	3-1-0	4	5	50	50	100	3 hours
2	15EMEC203	Fundamentals of Machine Design	PSC	3-1-0	4	5	50	50	100	3 hours
3	15EMEC204	Machines & Mechanisms	PSC	4-0-0	4	4	50	50	100	3 hours
4	15EMEF202	Engineering Materials	ES	4-0-0	4	4	50	50	100	3 hours
5	19EMEC202	Mechatronics	PSC	2-0-0	2	2	50	50	100	3 hours
6	18EMEP201	Manufacturing Processes-II Lab	PSC	0-0-2	2	4	80	20	100	2 hours
7	15EMEP204	Machines & Mechanisms Lab	PSC	0-0-1	1	2	80	20	100	2 hours
8	15EMEP202	Engineering Materials Lab.	PSC	0-0-1	1	2	80	20	100	2 hours
9	19EMEP202	Mechatronics Lab	PSC	0-0-2	2	4	80	20	100	2 hours
TOTAL				16-2-6	24	32				

ISA: In Semester Assessment, **ESA:** End Semester Assessment, **L:** Lecture, **T:** Tutorials, **P:** Practical. **PSC:** Program Specific Core, **BS:** Basic Science, **ES:** Engineering Science,

B.E. (Mechanical Engineering) Curriculum structure & Syllabus 2020 – 24 Batch

III Semester Bachelor of Engineering (Mechanical Engineering)

Curriculum Content

Course Code: 15EMAB201	Course Title: : Statistics and Integral transforms	
L-T-P: 4-0-0	Credits: 04	Contact Hours: 4 hrs/week
ISA Marks: 50	ESA Marks: 50	Total Marks: 100
Teaching Hours: 50	Examination Duration: 3hrs	

Unit – 1

- | | |
|--|-------|
| 1. Curve fitting and regression | 5 Hrs |
| Introduction to method of least squares, fitting of curves $y = a + bx$, $y = ab^x$, $y = a + bx + cx^2$, correlation and regression. Applications to civil Engineering problems | |
| 2. Probability | 8 Hrs |
| Definition of probability, addition rule, conditional probability, multiplication rule, Baye's rule. (no proof) Discrete and continuous random variables- PDF-CDF- Binomial, Poisson and Normal distributions (Problems only). | |
| 3. Tests of hypothesis-1 | 7 Hrs |
| Sampling, Sampling distribution, Standard error, Null and alternate hypothesis, Type -I and Type- II errors, Level of significance. Confidence limits, testing of hypothesis for single mean and difference of means (large samples). Applications to civil Engineering problems | |

Unit – 2

- | | |
|---|--------|
| 4. Tests of hypothesis-2 | 10 Hrs |
| t-test (test for single mean, paired t-test), Chi Squared distribution, analysis of variance (one-way and two-way classifications). Case studies of designs of experiments (CRD, RBD). Applications to civil Engineering problems | |
| 5. Laplace Transforms | 10 Hrs |
| Definition, transforms of elementary functions- transforms of derivatives and integrals- Properties. Periodic functions, Unit step functions and Unit impulse functions. Inverse Transforms- properties- Initial and Final value theorems, examples, Convolution Theorem. Applications to differential equations. | |

Unit – 3

- | | |
|--|-------|
| 6. Fourier Series | 5 Hrs |
| Fourier series representation of a function, Even and odd functions, half range series, Practical Harmonic Analysis | |
| 7. Fourier Transform | 5 Hrs |
| Exponential Representation of non-periodic functions, Existence of Fourier transforms properties of Fourier Transform: Fourier Sine and Cosine transforms. | |



B.E. (Mechanical Engineering) Curriculum structure & Syllabus 2020 – 24 Batch

Text Books

- 1 Gupta S C and Kapoor V K, Fundamentals of Mathematical Statistics, 9ed, Sultan Chand & Sons, New Delhi, 2002
- 2 J. Susan Milton, Jesse C. Arnold, Introduction to Probability and Statistics: Principles and Applications for Engineering and the Computing Sciences, 4th Ed, TATA McGraw-Hill Edition 2007.
- 3 Kreyszig, E, Advanced Engineering Mathematics, 8ed, John Wiley & sons, 2003.

Reference Books:

1. Kishor S Trivedi, probability and statistics with reliability queuing and computer science applications, PHI, 2000.
2. Miller, Freud and Johnson, Probability and Statistics for Engineering by, 5ed, PHI publications, 2000.
3. Potter M C, Jack Goldberg and Aboufadel E F, Advanced Engineering Mathematics, 3ed, Oxford Indian Edition, 2005.



B.E. (Mechanical Engineering) Curriculum structure & Syllabus 2020 – 24 Batch

Curriculum Content

Course Code: 15EMAB231	Course Title: Calculus and Integral transforms
L-T-P: 4-0-0	Credits: 04 Contact Hours: 4 hrs/week
ISA Marks: 50	ESA Marks: 50 Total Marks: 100
Teaching Hours: 50	Examination Duration: 3hrs

Unit – 1

- | | |
|---|--------|
| 1. Differential Calculus | 5 Hrs |
| Differentiation of standard functions of first and higher orders, Taylor's and Maclaurin's series expansion of simple functions for single variable. | |
| 2. Integral Calculus | 7 Hrs |
| Evaluation of integrals, properties, Beta and Gamma functions, relation between Beta and Gamma functions simple problems, Approximate integration- Trapezoidal rule, Simpson's 1/3 rule | |
| 3. Fourier Series | 10 Hrs |
| Fourier series, Evaluation of Fourier coefficients, Waveform symmetries as related to Fourier co-efficient, Exponential form of the Fourier series, half range Fourier series. Practical Harmonic Analysis. | |

Unit – 2

- | | |
|---|--------|
| 4. Fourier Transform | 8 Hrs |
| Exponential Representation of non-periodic signals, Existence of Fourier transforms properties of Fourier Transform: symmetry, scaling, shifting, Fourier transform of Sine and Cosine Convolution theorem. | |
| 5. Laplace Transforms | 10 Hrs |
| Definition, transforms of elementary functions- transforms of derivatives and integrals- Properties. Periodic functions, Unit step functions and Unit impulse functions. Inverse Transforms- properties- Initial and final value theorems and examples; Convolution Theorem. Applications to differential equations | |

Unit – 3

- | | |
|---|-------|
| 6. Ordinary differential equations of first order | 5 Hrs |
| Introduction, order and degree of equation, Solution of first order first-degree differential equations –variable separable methods, Linear differential equations, Bernoulli's equations, Initial value problems | |
| 7. Complex analysis | 5 Hrs |
| Function of complex variables. Limits, continuity and differentiability. Analytic functions, C-R equations in Cartesian and polar forms, construction of Analytic functions (Cartesian and polar forms). | |



B.E. (Mechanical Engineering) Curriculum structure & Syllabus 2020 – 24 Batch

Text Books:

1. Grewal B S, Higher Engineering Mathematics, 38ed, Khanna Publication, New Delhi, 2001
2. Bali and Iyengar, A text book of Engineering Mathematics, 6ed, Laxmi Publications(p) Ltd, New Delhi, 2003

Reference Books:

1. Calculus- James Stewart, Early Transcendentals Thomson Books, 5e 2007



B.E. (Mechanical Engineering) Curriculum structure & Syllabus 2020 – 24 Batch

Curriculum Content

Course Code: 15EMEF201

Course Title: Mechanics of Materials

L-T-P: 3-1-0

Credits: 4

Contact Hrs: 5 hrs/week

ISA Marks: 50

ESA Marks: 50

Total Marks: 100

Teaching Hrs: 40

Exam Duration: 3 hrs

Unit I

1. Stresses and Strains 10 Hrs

Normal and shear stress, bearing stress, strain, deformation, stress-strain diagram, Hooke's law, working stress and factor of safety, analysis of bars of constant and varying sections, principle of super position, Saint-Venant's principle, stresses in composite section, volumetric strain, elastic constants, statically indeterminate structures, thermal stresses.

2. Shear Force and Bending Moment in Beams 5 Hrs

Types of beams, supports and loads, shear force and bending moment diagrams for simply supported, overhanging and cantilever beams subjected to point loads, uniformly distributed load, uniformly varying load and couple.

Unit II

3. Stresses in Beams 5 Hrs

Bending stress, flexure formula, section modulus, bending stresses in beams of different cross sections, economic sections, shear stresses in beams, shear stress across rectangular, I and T sections.

4. Torsion and Buckling 5 Hrs

Torsion of circular shafts, torsional equation, power transmitted by solid and hollow circular shafts. Buckling: Elastic instability, critical load, Euler's equation for columns with different end conditions, Rankine's formula.

5. Compound stresses 5 Hrs

State of stress at a point, transformation of plane stress, principal planes and principal stresses, analytical method for determining principal stresses, maximum shear stress and their planes, Mohr's circle for plane stress.

Unit III

6. Deflection of Beams 5 Hrs

Deflection and slope of a beam, differential equation of the elastic curve, equations for deflection, slope and moment, double integration and Macaulay's method, deflection and slope for simply supported, overhanging and cantilever beams subjected to point loads, uniformly distributed load and couple.

7. Thin and Thick Cylinders 5 Hrs

Thin walled pressure vessels, cylindrical vessels; hoop stress, longitudinal stress and maximum shear stress, change in dimensions of cylinder (diameter, length and volume), spherical vessels, thick cylinders subjected to internal and external pressures (Lame's equation).

Text Books:

1. Andrew Pytel and JaanKiusalaas, Mechanics of Materials, 2nd Edition, Cengage Learning, 2012.
2. R.C. Hibbeler, Mechanics of Materials, 9th Edition, Pearson Education, 2018.



B.E. (Mechanical Engineering) Curriculum structure & Syllabus 2020 – 24 Batch

Reference Books:

1. James M. Gere and Barry J. Goodno, Mechanics of Materials, 8th Edition, Nelson Engineering International Edition, 2012.
2. Ferdinand Beer, Jr. E. Russell Johnston, John Dewolf and David Mazurek, Mechanics of Materials, 7th Edition, McGraw-Hill Education, 2014.



B.E. (Mechanical Engineering) Curriculum structure & Syllabus 2020 – 24 Batch

Curriculum Content

Course Code: 15EMEC201

Course Title: Manufacturing Processes

L-T-P: 4-0-0

Credits: 4

Contact Hrs: 4 hrs/week

ISA Marks: 50

ESA Marks: 50

Total Marks: 100

Teaching Hrs: 50

Exam Duration: 3 hrs

Unit I

1. Introduction to Manufacturing Processes

2 Hrs

Definition of manufacturing, Manufacturing sectors and their significance to the economy of a country, Classification of production processes and systems, Criteria for selection of a process for production, Sustainable manufacturing.

2. Casting & special casting processes

12 Hrs

Casting: Introduction, Green sand molding, Pattern & core making: Pattern types, allowances and materials, Core & core making methods, Molding methods and machines, Principles of gating, Risers and gating ratio. Special Casting Processes: CO₂ molding, Shell molding, Investment casting, Die casting, Centrifugal casting processes and Continuous casting process. Melting Furnaces: Crucible furnaces, Electric arc furnaces, Induction furnaces. Defects in castings, Cleaning and fettling operations, Testing methods.

3. Fabrication Processes

6 Hrs

Classification of joining processes, Soldering, Brazing, Mechanical fastening, Welding, Preparation of base metal and joint. Arc welding, Gas welding, TIG, MIG, FCAW, Thermit welding, Spot, seam and projection welding, Ultrasonic welding, Electron beam welding and Laser welding.

Unit II

4. Machine Tool Operations

5 Hrs

Principles of metal cutting, Introduction to Lathes, Drilling and Milling machines, Constructional features, Operations, Machining time calculations. Grinding, Super finishing, Honing and Lapping methods; Constructional features, Operations and types.

5. Mechanics of Machining

10 Hrs

Geometry of cutting tools, Cutting tool materials, Mechanism of chip formation, Merchant's circle diagram, Velocity and force relationships, Cutting fluids, Thermal aspects of machining, Types of tool wear & wear mechanisms, Tool life, Machinability & its criteria, Numerical on force analysis and tool life.

6. Forming Processes

5 Hrs

Bulk deformation processes: Forging, Rolling, Extrusion and Drawing. Sheet metal working processes, Selection of equipment, Numerical on die design.

Unit III

7. Advanced Manufacturing Processes

5 Hrs

Non-traditional Machining Processes: Mechanical, Thermal, Electrochemical and Chemical machining processes. Micro-machining and Additive manufacturing.

7. Digital Manufacturing

5 Hrs

Introduction to Digital Manufacturing & Design, Digital Thread: Components & Implementation, Advanced Manufacturing Process Analysis, Intelligent Machining, Advanced Manufacturing Enterprise, Cyber Security in Manufacturing, Model-Based Systems Engineering, Roadmap to Industry 4.0.



B.E. (Mechanical Engineering) Curriculum structure & Syllabus 2020 – 24 Batch

Text Books:

1. Kalpakjian S., and Schmid S.R., Manufacturing Engineering & Technology, 7th edition, Pearson Education, 2014.
2. Mikell P. Groover, Fundamentals of Modern Manufacturing, 5th edition, John Wiley & Sons, 2012.

Reference Books:

1. Juneja B. L. and Sekhon G. S., Fundamentals of Metal Cutting and Machine Tools, 3rd edition, New Age International Limited, 2008.
2. Rosenthal, P., Heine L., Principles of Metal Casting, Tata McGraw Hill, 1997.
3. John A. Schey, Introduction to Manufacturing Processes, 3rd edition, Tata McGraw Hill, 1999.
4. Mikell P. Groover, Automation, Production Systems, and Computer-Integrated Manufacturing, 4th edition, Prentice Hall, 2014.
5. Pandey P. C. and Shan H. S., Modern Machining Processes, 1st edition, Tata McGraw Hill, 2013.
6. Rao P. N., Manufacturing Technology: Volume-1, 3rd edition, Tata McGraw Hill, 2008.
7. Rao P. N., Manufacturing Technology: Volume-2, 3rd edition, Tata McGraw Hill, 2013.
8. Ustundag Alp, and Cevikcan Emre, Industry 4.0: Managing the Digital Transformation, Springer series in Advanced Manufacturing, 2018.



**B.E. (Mechanical Engineering) Curriculum structure & Syllabus 2020 – 24 Batch
Curriculum Content**

Course Code: 15EMEC202

Course Title: Engineering Thermodynamics

L-T-P: 3-0-0

Credits: 3

Contact Hrs: 3 hrs/week

ISA Marks: 50

ESA Marks: 50

Total Marks: 100

Teaching Hrs: 40

Exam Duration: 3 hrs

Unit I

1. Introduction

7 Hrs

Basic concepts, Zeroth law, 1st law of thermodynamics applied to non flow system and flow system, Thermodynamic processes.

2. Second Law of Thermodynamics

8 Hrs

Devices converting heat to work; (a) in a thermodynamic cycle, (b) in a mechanical cycle. Thermal reservoir. Direct heat engine; schematic representation and efficiency. Devices converting work to heat in a thermodynamic cycle; reversed heat engine, schematic representation, coefficient of performance. Classical statements of second law of thermodynamics, PMM I and PMM II, factors that make a process irreversible, reversible heat engines, Carnot cycle, Carnot theorem, thermodynamic temperature scale.

Unit II

3. Entropy

6 Hrs

Entropy a property of a system, Clausius theorem and Clausius inequality, Principle of increase of entropy, calculation of entropy change during various processes, Tds relations, Exergy and energy, Exergy analysis.

4. Gas and Vapor Power Cycles

9 Hrs

Gas power cycles: Otto, Diesel, Dual and Stirling cycles, expression for mean effective pressure and cycle efficiency, comparison of Otto, Diesel and Dual cycles. Vapor power cycle: Carnot cycle, work done and cycle efficiency, draw backs, ideal and actual Rankine cycle, network done, cycle efficiency and work ratio.

Unit III

5. Reciprocating air compressor

5 Hrs

Classification, work done in single stage and multi stage compressor, intercooling, efficiencies of air compressor, condition for minimum work, numerical on single and multistage compressor.

6. Refrigeration

5 Hrs

Vapor compression refrigeration system; description, analysis, refrigerating effect, capacity, power required, units of refrigeration, COP. Refrigerants and their desirable properties: Air cycle refrigeration; reversed Carnot cycle, reversed Brayton cycle. Vapor absorption refrigeration system.

Text Books:

1. Michael J Moran & Howard N Shapiro, Fundamentals of engineering thermodynamics, 9th Edition, Wiley Stud, 2018.
2. Yunus A. Cengel, Michael A. Boles, Mehmet Kanoglu, Thermodynamics an Engineering approach, 9th Edition, Tata McGraw, 2019



B.E. (Mechanical Engineering) Curriculum structure & Syllabus 2020 – 24 Batch

Reference Books:

1. Jean-Paul Duroudier, Thermodynamics, 1st Edition, ISTE Press - Elsevier, 2016.
2. Yousef Haseli, Entropy Analysis in Thermal Engineering system, 1st Edition, Academic Press, 2019.

B.E. (Mechanical Engineering) Curriculum structure & Syllabus 2020 – 24 Batch

Curriculum Content

Course Code: 19EMEC201

Course Title: Control Systems

L-T-P: 2-1-0

Credits: 3

Contact Hrs: 4 hrs/week

ISA Marks: 50

ESA Marks: 50

Total Marks: 100

Teaching Hrs: 30

Exam Duration: 3 hrs

Unit – 1

1. Introduction to Control System

3 hrs

Generalized configurations and functional description of control systems. Control system design. Examples of Control System. Introduction to Linear, Nonlinear, Time Variant and Time Invariant systems.

2. Modeling of Physical Systems:

8 hrs

Introduction, Differential equations of physical systems, The Laplace Transform, Order of system; The transfer function of linear and rotational Mechanical systems, Gear Train, Electrical systems, Electro-mechanical System, Thermal systems, Hydraulic System; Block representation of system elements and Reduction of block diagrams.

Unit – 2

3. System Response

6 hrs

Introduction, Poles, Zeros, and System Response. First-order system response to step, ramp and impulse inputs. Second-order system response to step input; Un-damped, Under damped, Critical damped and Over damped systems, Time response specifications. Design of 1st and 2nd order system.

4. System Stability

5 hrs

Introduction to stability. Stability analysis by time response, S-plane and Routh-Hurwitz Criterion. Effect of gain adjustment, addition of pole and addition of zero on system response and system stability. Defining the Root locus, General rules for constructing root loci, Sketching the Root locus.

Unit – 3

5. Frequency Domain Analysis

4 hrs

Nyquist stability criteria, Bode Plots. Stability analysis using bode plots.

6. Control Action

4 hrs

Introduction to PID controller design. Types of Controllers, Mathematical modeling of PID, ON-OFF controller, Effect of Proportional, Derivative and Integral elements on system behavior, Design of Controller for given simple applications. Controller Design using root locus.

Text Book:

1. Richard C Dorf and Robert H. Bishop, Modern Control Systems, 12th edition, Addison Wesley
2. A. Anandkumar, Control Systems, 2nd edition, PHI Learning Private Limited, 2014.

Reference Book:

1. Katsuhiko Ogata, Modern Control Engineering, 5th edition, Pearson Publications.
2. Norman S. Nise, Control. Systems, 6th edition, John Wiley & Sons



B.E. (Mechanical Engineering) Curriculum structure & Syllabus 2020 – 24 Batch

Curriculum Content

Course Code: 16EMEP201

Course Title: Manufacturing Processes Lab

L-T-P: 0-0-1

Credits: 1

Contact Hrs: 2 hrs/week

ISA Marks: 80

ESA Marks: 20

Total Marks: 100

Teaching Hrs: 26

Exam Duration: 2 hrs

Content

Lab Exercises

- | | |
|--|--------|
| 1. Machining practices involving machining time calculation and estimation of machining cost for the jobs for turning, taper turning, threading, knurling. | 6 Hrs |
| 2. To manufacture and assemble parts for ball valve which involves turning, milling, tapping/slot milling, etc. | 14 Hrs |
| 3. Design, Modeling and Analysis of Bulk deformation and Sheet Metal forming processes. | 4 Hrs |
| 4. Demonstration of CNC machines and Non-traditional machines such as laser cutting, plasma cutting, electro-discharge machine. | 2 Hrs |

Text Books:

1. Kalpakjian S., and Schmid S.R., Manufacturing Engineering & Technology, 7th edition, Pearson Education, 2014.
2. Mikell P. Groover, Fundamentals of Modern Manufacturing, 5th edition, John Wiley & Sons, 2012.

Reference Books:

1. Juneja B. L. and Sekhon G. S., Fundamentals of Metal Cutting and Machine Tools, 3rd edition, New Age International Limited, 2008.
2. Rosenthal, P., Heine L., Principles of Metal Casting, Tata McGraw Hill, 1997.
3. John A. Schey, Introduction to Manufacturing Processes, 3rd edition, Tata McGraw Hill, 1999.
4. Mikell P. Groover, Automation, Production Systems, and Computer-Integrated Manufacturing, 4th edition, Prentice Hall, 2014.
5. Pandey P. C. and Shan H. S., Modern Machining Processes, 1st edition, Tata McGraw Hill, 2013.



B.E. (Mechanical Engineering) Curriculum structure & Syllabus 2020 – 24 Batch

Curriculum Content

Course Code: 19EMEP201

Course Title: Control Systems Lab

L-T-P: 0-0-2

Credits: 2

Contact Hrs: 4 hrs/week

ISA Marks: 80

ESA Marks: 20

Total Marks: 100

Teaching Hrs: 48

Exam Duration: 2 hrs

Experiment Number	Experiments	No of sessions
01	Scaffolding exercises to explore MATLAB / Simulink software package.	04
02	Modelling of physical systems and its response analysis	06
03	Design and investigate the effects of various controllers on a system.	03
04	Comparative study of Time response, root locus and Bode plot with respect to stability.	02
	Control system analysis: Case Studies	06
05	✓ Hydraulic Lift ✓ DC servo motor	
06	Case Study (Open Ended)	03

Text Book:

1. Richard C Dorf and Robert H. Bishop, Modern Control Systems, 12th edition, Addison Wesley
2. A. Anandkumar, Control Systems, 2nd edition, PHI Learning Private Limited, 2014.

Reference Book:

1. Katsuhiko Ogata, Modern Control Engineering, 5th edition, Pearson Publications.
2. Norman S. Nise, Control. Systems, 6th edition, John Wiley & Sons.
3. Data sheets provided by manufactures.



B.E. (Mechanical Engineering) Curriculum structure & Syllabus 2020 – 24 Batch

Curriculum Content

Course Code: 18EMEP203

Course Title: Machine Drawing Lab

L-T-P: 0-0-1

Credits: 1

Contact Hrs: 2 hrs/week

ISA Marks: 80

ESA Marks:20

Total Marks: 100

Teaching Hrs: 26

Exam Duration: 2 hrs

Laboratory Content

1. Sectional views 8 Hrs

Sectional views of machine parts involving half section, full section, offset section, revolved section and local section (use 1st and 3rd angle of projection).

2. Threaded Fasteners 6 Hrs

Drawing of bolts, nuts, screws and their conventional representation.

3. Part and Assembly Drawing 8 Hrs

Drawing of part and assembly drawing of machines such as:

(1) Screw Jack. (2) Protected type flanged coupling. (3) Pipe vice. (4) Clapper box. (5) Non-return valve. (6) Universal coupling. (7) Pin and cotter joints.

4. Assembly Drawing using CAD tool 4 Hrs

Assembly drawing of machines such as:

(1) Screw Jack. (2) Protected type flanged coupling. (3) Pipe vice. (4) Clapper box. (5) Non-return valve. (6) Universal coupling. (7) Pin and cotter joints.

Text Books:

1. Machine Drawing by K. R. Gopalakrishna, Subhas Publications, 22nd Edition - 2013.
2. Machine Drawing by N. D. Bhat & V. M. Panchal, Charotar Publishing House.
3. A Text Book of Computer Aided Machine Drawing, S. Trymbaka Murthy, CBS Publishers, New Delhi, 2007 Edition.

Reference Books:

1. Engineering drawing practice for schools and colleges SP 46:2003 (BIS).



B.E. (Mechanical Engineering) Curriculum structure & Syllabus 2020 – 24 Batch

IV Semester Bachelor of Engineering (Mechanical Engineering)

Curriculum Content

Course Code: 19EMAB206 **Course Title: Numerical methods and Partial differential equations**

L-T-P: 3-1-0 Credits: 04 Contact Hours: 65
CIE Marks: 50 SEE Marks: 50 Total Marks: 100
Teaching Hours: 40 Examination Duration: 3hrs

Unit - 1

1. Interpolation techniques 8 Hrs

Finite differences, Forward, Backward and central difference operators. Newton Gregory forward and backward interpolation formulae. Sterling's and Bessel's formulae for central difference, Newton's divided difference formula for un equal intervals. Heat transfer problem, gas law problem-shear stress problem-using interpolation.

Python: Interpolation problems related to Mechanical engineering

2. Matrices and System of linear equations 7 Hrs

Introduction to system of linear equations, Rank of a matrix by elementary row transformations. Consistency of system of linear equations, solution of system by Direct methods-Gauss elimination, Gauss Jordan method. Solution of homogenous system $AX=0$, Eigenvalues and Eigenvectors of a matrix.

Python: Matrices, system of linear equations by Gauss elimination, Gauss Jordan and eigenvalue problems

Unit - 2

3. Numerical solution of linear equations 5 Hrs

Solution of system of equations by Iterative methods- Guass-Seidal method. Largest Eigenvalue and the corresponding Eigenvector by power method. Spring mass system Falling parachutist using system of equations.

Python: Application problems on mechanical engineering

4. Partial differential equations 10 Hrs

Introduction, classification of PDE, Formation of PDE, Solution of equation of the type $Pp + Qq = R$, Solution of partial differential equation by direct integration methods, method of separation of variables. Modeling: Vibration of one-dimensional string-wave equation and heat equation. Laplace equation. Solution by method of separation of variables.

Python: Solution of Partial differential equations

Unit – 3

5. Finite difference method. 10 Hrs

- (a) Finite difference approximations to derivatives, finite difference solution of parabolic PDE explicit and Crank-Nicholson implicit methods. Engineering Problems: Temperature distribution in a heated plate
- (b) Hyperbolic PDE-explicit method, Elliptic PDE-initial-boundary value problems.

Vibration of a stretched string, steady-state heat flow.

Python: Finite difference solution of Partial differential equations.



B.E. (Mechanical Engineering) Curriculum structure & Syllabus 2020 – 24 Batch

Text Books

1. Kreyszig E., Advanced Engineering Mathematics, 8ed, John Wiley & sons, 2003.
2. Potter M C, Jack Goldberg and Aboufadel E F, Advanced Engineering Mathematics, 3ed, Oxford Indian Edition, 2005.
3. Grewal B S, Higher Engineering Mathematics, 38ed, TATA McGraw-Hill, 2001.

Reference Books:

1. Burden R L and Douglas Faires J, Numerical Analysis, 7ed, Thomson publishers, 2006.
2. Simmons G F and Krantz S G, Differential Equations, TATA McGraw-Hill, 2007.
3. Sastry S S, Introductory method for numerical analysis, 3ed, PHI, 2003
4. Chapra S C and Canale R P, Numerical methods for Engineers, 5ed, TATA McGraw-Hill, 2007.



B.E. (Mechanical Engineering) Curriculum structure & Syllabus 2020 – 24 Batch

Curriculum Content

Course Code: 15EMEC203	Course Title: Fundamentals of Machine Design
L-T-P: 3-1-0	Credits: 4 Contact Hrs: 5 hrs/week
ISA Marks: 50	ESA Marks: 50 Total Marks: 100
Teaching Hrs: 40	Exam Duration: 03

Unit I

1. Introduction to Machine Design 4 Hrs

Machine Design, Basic Procedure of Machine Design, Design of Machine elements, Traditional design methods, Design synthesis, Use of Standards in Design, Selection of prepared sizes, Aesthetic considerations in design, Ergonomic considerations in design, Concurrent Engineering.

2. Design against Static Load 6 Hrs

Modes of failure, factor of safety, eccentric axial loading, design of machine parts, Stress Concentration, Stress Concentration Factors, Reduction of Stress Concentration. Theories of Elastic failure, Maximum Principal Stress Theory, Maximum Shear Stress Theory, Distortion-Energy Theory, Selection and use of failure Theories.

3. Design against Reversing load 5 Hrs

Fluctuating Stresses, Fatigue Failure, Endurance Limit, Low cycle, and High Cycle Fatigue, Notch Sensitivity, Endurance Limit- Approximate Estimation, Reversed Stresses- Design for Finite and Infinite Life

Unit II

4. Design against Fluctuating load 4 Hrs

Cumulative Damage in Fatigue, Soderberg and Goodman equations. Fatigue design under combined stresses. Impact Stresses.

5. Design of Belt Drives 5 Hrs

Introduction to Belt drives, Materials for Belts, Advantages, and disadvantages of V belts over flat belt drives, Dimensions of standard V grooved pulley, Power transmission, Number of belts, Centre distance, Pitch length of the belt, Ratio of driving tensions, Design procedure of V belts.

6. Shafts and Keys 7 Hrs

Transmission Shafts, Shaft Design on Strength Basis, Shaft Design on Torsional rigidity Basis, ASME Code for shaft design, Design of Shafts subjected to combined bending and twisting. Keys, Saddle and Sunk keys, Design of square and flat Key.

Unit III

7. Temporary Joints 5 Hrs

Bolted joint –simple analysis, eccentric load perpendicular to the axis of the bolt, eccentric load parallel to the axis of bolt

8. Permanent Joints 5 Hrs

Welded Joints, Strength of Butt Welds, Strength of Parallel fillet Welds, Strength of Transverse Fillet Welds, Eccentric Loaded welded joints, Riveted Joints, Types of riveted joints, Types of failures, Design of butt and lap joints for Boilers.

Text Books:

1. V.B. Bhandari, Design of Machine Elements, Fourth Edition, Tata McGraw Hill Publishing Company Ltd., New Delhi, 2017.



B.E. (Mechanical Engineering) Curriculum structure & Syllabus 2020 – 24 Batch

Reference Books:

1. T. Krishna Rao, Design of Machine Elements (Volume I), Second Edition, I K International Publishing House Pvt. Ltd., New Delhi, 2015.
2. Farazdak Haideri, Mechanical Engineering Design (Volume I), Second Edition, Nirali Prakashan, Pune, 2012.
3. K. Mahadevan and Balaveera Reddy, Design Data Hand Book, CBS Publication, Fourth Edition. 2016.



B.E. (Mechanical Engineering) Curriculum structure & Syllabus 2020 – 24 Batch

Curriculum Content

Course Code: 15EMEC204

Course Title: Machines & Mechanisms

L-T-P: 4-0-0

Credits: 4

Contact Hrs.: 4 hrs/week

ISA Marks: 50

ESA Marks: 50

Total Marks: 100

Teaching Hrs.: 50

Exam Duration: 3 hrs.

Unit I

1. Kinematics Fundamentals

10 Hrs

Links, pairs, mechanisms, machines, structure, and inversions. Identifying types of links, pairs, drawing kinematic diagram and finding mobility of linkages. Inversions of four bar mechanism, single slider crank mechanism, and double slider crank mechanism. Steering gear mechanisms, Intermediate motion mechanisms, Hook's joint analysis with examples.

2. Kinematic Analysis of Mechanisms

10 Hrs

Locating instantaneous centers for simple mechanisms. Velocity and Acceleration of four bar mechanisms, slider crank mechanisms by relative velocity method. Velocity and acceleration analysis of four bar mechanism and slider crank mechanism by complex algebra method. Numericals.

Unit II

3. Static and Dynamic analysis of Mechanisms

8 Hrs

Static force analysis of four bar mechanisms, slider cranks mechanisms. Inertia forces and torque, inertia forces on engine mechanism, TMD for different machines. Fluctuation of energy, design of flywheel. Numericals.

4. Kinematic analysis of Gear and Gear Trains

6 Hrs

Classification and terminology of gears, Involutometry, backlash in gears, Law of gearing, velocity of sliding, length of path of contact, arc of contact, contact ratio, Numericals. Different types of gear trains, Numericals on Epicyclic gear train.

5. Balancing of masses

6 Hrs

Necessity of balancing, Static and Dynamic balancing, Balancing of revolving masses in single and multiple planes. Balancing of reciprocating masses, Balancing of multi cylinder inline engine. Numericals.

Unit III

6. Cams

5 Hrs

Introduction, classification of followers and cams. Construction of Displacement diagrams, velocity and acceleration diagrams with designing the cam profile for disc cam and roller follower combination for the following cases: Simple Harmonic Motion (SHM), Uniform Acceleration and Retardation, Numericals.

7. Gyroscope

5 Hrs

Gyroscopic couple and precessional motion, effect of gyroscopic couple on airplane and ship during steering and rolling. Stability of two wheels and four wheel drives taking turn. Numericals

Text Books:

1. R. L. Norton, Kinematics and Dynamics of Machinery, 2nded, Tata McGraw Hill, New Delhi.
2. David Myszk, Machines and Mechanisms- Applied Kinematic Analysis, 3rded, PHI, New Delhi.



B.E. (Mechanical Engineering) Curriculum structure & Syllabus 2020 – 24 Batch

Reference Books:

1. John Uicker , Gordon Pennock , Joseph Shigley, Theory of Machines and Mechanisms, 4thed, Oxford University Press-NEW DELHI.
2. S. S. Rattan, Theory of Machines, 2nded, Tata McGraw Hill Publishing Company Ltd., New Delhi.



B.E. (Mechanical Engineering) Curriculum structure & Syllabus 2020 – 24 Batch

Curriculum Content

Course Code: 15EMEF202

Course Title: Engineering Materials

L-T-P : 4-0-0

Credits:4

Contact Hrs: 4hrs/week

ISA Marks: 50

ESA Marks: 50

Total Marks: 100

Teaching Hrs: 50

Exam Duration: 03hrs

Unit I

1. Introduction

5 Hrs

An overview of materials science and engineering, classes of engineering materials, functional and advanced materials, Materials history and character, Design-limiting properties, Material property charts, Matching materials to design, Selection strategy-translation, screening, ranking and documentation.

2: Structures of Metals and ceramics:

5 Hrs

Macro-Micro-Nano: The scale of structures, Crystal Structures- BCC, FCC, HCP structures; coordination number, atomic packing factor, Imperfections in solids and their roles in affecting the behavior of materials., Plastic deformation of single crystal by slip and twinning, dislocation theory.

3: Mechanical Behavior of materials:

10 Hrs

Stress-strain diagrams to show ductile and brittle behavior of materials, linear and nonlinear elastic behavior of materials, mechanical properties in elastic and plastic range, Effect of strain rate and temperature on tensile properties, **Fatigue:** Types of fatigue loading with example, mechanism of fatigue, fatigue properties, fatigue testing and SN diagram; **Creep:** Description of phenomenon with examples, stages of creep, creep properties, stress relaxation; **Fracture:** Failure of engineering materials.

Unit II

4: Solidification and phase diagrams:

7 Hrs

Mechanism of solidification, Homogeneous and heterogeneous nucleation, crystal growth, cast metal structures, Solid solutions, Hume Rothery rules, substitutional and interstitial solid solutions, intermediate phases, Gibbs phase rule, construction of equilibrium diagrams, equilibrium diagrams involving complete and partial solubility, lever rule, Iron carbon equilibrium diagram, description of phases, solidification of steels and cast irons, invariant reactions, Numericals.

5: Ferrous and Nonferrous materials:

7 Hrs

Properties, composition and uses of cast irons and steels, AISI and BIS designation of steels. Aluminum, Magnesium and Titanium alloys.

6: Heat treatment of metals:

6 Hrs

Objectives, Annealing and its types, normalizing, hardening, tempering, austempering, martempering, hardenability, surface hardening methods like carburizing, cyaniding, nitriding, flame hardening and induction hardening; Age hardening of Aluminum -Copper alloys. Time-temperature-transformation (TTT) curves, continuous cooling curves.

Unit III



B.E. (Mechanical Engineering) Curriculum structure & Syllabus 2020 – 24 Batch

7: Ceramic and Polymer Materials:

5 Hrs

An overview of ceramic materials, mechanical and thermal properties of ceramics, An overview of polymeric materials, thermoplastics and thermosets, elastomers, engineering applications of ceramic and polymer materials.

8: Advanced materials:

5 Hrs

The need for advanced materials; Composite materials- classification, types of matrix materials and reinforcements, fundamentals of production of FRP's and MMC's, applications of composites, Smart materials, Nano materials and Exotic alloys.

Text Books:

1. William Callister, Materials Science and Engineering, John Wiley & Sons. Inc., 10th Edition, January 2018 (ISBN: 978-1-119-40549-8).
2. Michael Ashby and D R H Jones, Engineering Materials: An Introduction to Properties, Applications and Design- 5th Edition, Butterworth-Heinemann, December 2018.

Reference Books:

1. Donald Askeland and Pradeep Phule, The Science and Engineering of Materials Thompson Learning, 7th Edition, CENGAGE Learning, 2019.
2. George Murray, Charles V. White, Wolfgang Weise, Introduction to Engineering Materials, 2nd Edition, CRC Press, 07-Sep-2007



B.E. (Mechanical Engineering) Curriculum structure & Syllabus 2020 – 24 Batch

Curriculum Content

Course Code: 19EMEC202

Course Title: Mechatronics

L-T-P: 2-0-0

Credits: 2

Contact Hrs: 2 hrs/week

ISA Marks: 50

ESA Marks: 50

Total Marks: 100

Teaching Hrs: 30

Exam Duration: 3 hrs

Unit – 1

1. Introduction to Mechatronics: Definition & overview of Mechatronics, Key elements, Real time Simulation, Mechatronics Design approach, examples of mechatronic systems. 3 hrs

2. Signal conditioning: Introduction, Amplification, Filtering, Isolation and Protection, Linearization, Multiplexing, De-multiplexing Encoder, Decoder, ADC and DAC Process; Data Acquisition System (DAQ). 4 hrs

3. Sensors and transducers: Introduction, Motion measurement – Displacement, Position, Velocity, Acceleration and proximity measurements. Temperature, Force, Torque and Power measurement, Pressure and Flow rate measurement. 4 hrs

Unit – 2

4. Basics of Computational systems: Latch, Flip Flop(SR, JK, D, T), Registers, Counters; Analog and Digital circuits for Computational system realization, Memory Hierarchy, Typical working of a Digital Computational system, Fundamentals of Micro-controller/ Microprocessor and FPGA: Timer, Counter, interrupts; Different Architectures. 6 hrs

5. PLC and its programming: Introduction, PLC hardware and its architecture, Basics of ladder diagram, Concepts of Latching, interlocking, timer and counter. Applications. 5 hrs

Unit – 3

6. Electro-Mechanical Actuators : Relay, Solenoid, DC motor, Stepper motor, AC and DC Servo motor, Drive Circuits. Characteristics and selection of Actuators. 4 hrs

7. User Interface and communication system: Introduction, Hardware's for user interface like joystick, display; Software as User Interface like command-line, menu driven and graphical user interface (GUI). Data transmission medium; Basics of serial and Parallel Communication, Basics of network topologies; Other communication protocols. 4 hrs

Text Book:

1. W. Bolton, "Mechatronics", 2nd edition, Pearson Ed, 2001
2. SABRI CETINKUNT "Mechatronics with Experiments", 2nd edition, John Wiley & Sons Ltd, 2015
3. Petruzella D Frank, "Programming Logic Controllers", 3rd edition, Mc Graw Hill Education, 2010

Reference Book:

1. Devdas Shetty, Richard Kolk, "Mechatronics System Design", 2nd edition,
2. Robert H. Bishop, "MECHATRONICS an Introduction", 1st edition, Taylor & F, 2006.

B.E. (Mechanical Engineering) Curriculum structure & Syllabus 2020 – 24 Batch

Curriculum Content

Course Code: 18EMEP201

Course Title: Manufacturing Processes - II Lab

L-T-P: 0-0-2

Credits: 2

Contact Hrs: 4 hrs/week

ISA Marks: 80

ESA Marks: 20

Total Marks: 100

Teaching Hrs: 48

Exam Duration: 2 hrs

Content

Processing of plastics & rubber goods:

Production of sheet and film, fiber and filament production, injection molding, blow molding & rotational molding, thermoforming, casting, product design considerations

Rubber processing & shaping, manufacture of tires & other rubber products, product design considerations

Rapid prototyping processes:

Fundamentals of rapid prototyping, relationship between reverse engineering and rapid prototyping, subtractive processes, additive processes

Design of jigs/fixtures:

Difference between jigs and fixtures, General consideration in design of drill jigs, Drill bushing

Non-conventional machining processes:

Mechanical and thermal machining processes

Lab Exercises

- | | |
|---|--------|
| 1. Injection molding: Produce a component in injection molding process for given component drawing. | 2 Hrs |
| 2. FRP: Prepare a component by hand layup process for FRP product. | 2 Hrs |
| 3. Rubber processing: Conduct the rubber manufacturing processes for given component drawing. | 2 Hrs |
| 4. Non-conventional machining: Study the effect of process parameters in electric-discharge machining, laser cutting and plasma arc machining for a given geometry. | 6 Hrs |
| 5. RPT (3D printing): Build a product in 3D printing machine for given component drawing. | 4 Hrs |
| 6. CNC machining: Prepare CNC program and conduct turning & milling machining for a given component. | 20 Hrs |
| 7. Jigs/Fixtures: Design a jig/fixture for given application. | 12 Hrs |

Text Books:

1. Kalpakjian S., and Schmid S.R., Manufacturing Engineering & Technology, 7th edition, Pearson Education, 2014.
2. Mikell P. Groover, Fundamentals of Modern Manufacturing, 5th edition, John Wiley & Sons, 2012.

Reference Books:

1. Tadmor Zehev, Gogos Costas G., Principles of Polymer Processing, 2nd edition, A John Wiley & Sons, Inc., Publication, 2006.
2. Chee Kai Chua, Kah Fai Leong, Chu Sing Lim, Rapid Prototyping: Principles and Applications, 3rd edition, World Scientific Pub Co Inc, 2010.
3. Rahaman M. N., Ceramic Processing, 2nd edition, CRC Press, 2003.



B.E. (Mechanical Engineering) Curriculum structure & Syllabus 2020 – 24 Batch

Curriculum Content

Course Code: 15EMEP204

Course Title: Machines & Mechanisms Lab

L-T-P: 0-0-1

Credits: 1

Contact Hrs: 2 hrs/week

ISA Marks: 80

ESA Marks: 20

Total Marks: 100

Teaching Hrs: 24

Exam Duration: 2 hrs

S.No	Experiments	Hrs
1	Introduction to software and exercises	4
2	Determination of the Mobility of linkages	2
3	Velocity and Acceleration analysis on applications of slider crank mechanisms	2
4	Velocity and Acceleration analysis on applications of 4 bar mechanisms	2
5	Kinematic analysis of a Epicyclic Gear Train	2
6	Determination of gyroscopic couple and verification of gyroscopic law	2
7	Balancing of a system of rotating masses in a single plane	2
8	Balancing of a system of rotating masses in a Multiple planes	2
9	Kinematic analysis of a cam follower pair for specific inputs	4
10	Construction of the best suited mechanism and analysis of the mechanism using traditional and/or modern tools for a specific application	2

Text Books:

1. David Myszka, **Machines and Mechanisms- Applied Kinematic Analysis**, 3rd Edition, PHI, New Delhi,

Reference Books:

1. John Uicker, Gordon Pennock, Joseph Shigley, **Theory of Machines and Mechanisms**, 4th Edition, Oxford University Press, New Delhi
2. A brief introduction to MSC.ADAMS-user manual, McNeil Schindler Corp (MSC), USA.
3. "Make it Kit", An educational Mechanism construction kit.



B.E. (Mechanical Engineering) Curriculum structure & Syllabus 2020 – 24 Batch

Curriculum Content

Course Code: 15EMEP202	Course Title: Engineering Materials Lab	
L-T-P: 0-0-1	Credits: 1	Contact Hrs: 2 hrs/week
ISA Marks: 80	ESA Marks: 20	Total Marks: 100
Teaching Hrs: 24		Exam Duration: 2 hrs

Expt. No.	Brief description about the experiment	No. of Lab. Slots
01	Introduction to the Laboratory-Overview of Destructive and Non Destructive Testing methods. (Awareness about the ASM hand books and ASTM standards)	01
02	Non destructive test experiments a. Ultrasonic flaw detection. b. Magnetic particle inspection. c. Dye penetration testing, To study the defects of castings and welded specimens.	01
03	Evaluation of the tensile strength, Compression strength, Shear strength,	01
04	Bending/ Torsion strength and Impact strength. Ex: Should be able to Describe the differences between the tensile behavior of the metal sample and that of polymer sample, considering that the student performs the test on two different materials family.	01
05	To study wear characteristics of ferrous, non-ferrous and composite materials for different loading. Computation of wear parameters: wear rate, wear resistance, specific wear rate, frictional force, coefficient of friction, wear coefficient.	01
06	To study the microstructure of the ferrous and nonferrous alloy and to perform grain size analysis and volume fraction analysis. • Familiarization with the procedure for preparation of a material specimen for microscopic examination. • Familiarization with compound optical microscopes and metallography. • Examination of surface characteristics of engineering materials. • Grain size determination of metals and analysis.	01
07	To analyze given SEM Micrographs (Microstructure and fracture surface morphology) and conclude on the structure and mode of fracture. (Familiarization with the advanced characterization of metals by Scanning electron microscopy).	01
08	Computer Modeling of Stress Concentration, Crack Opening and Crack	01



B.E. (Mechanical Engineering) Curriculum structure & Syllabus 2020 – 24 Batch

Propagation

Understand the occurrence of stress concentration at geometrical discontinuities.

Determine the stress concentration factor at a geometrical discontinuity.

- | | | |
|----|--|----|
| 09 | Design an experiment to investigate the spring characteristics of any given spring. | 02 |
| 10 | Synthesize a novel composite material which is reinforced with a natural fiber in a polymer matrix and perform the mechanical characterization for investigation of mechanical properties, which is desirable for specified engineering applications.
Perform a parametric analysis which affects the mechanical properties of prepared composites using a statistical approach and find the correlation of those parameters with properties of composites. | 02 |



B.E. (Mechanical Engineering) Curriculum structure & Syllabus 2020 – 24 Batch

Curriculum Content

Course Code: 19EMEP202

Course Title: Mechatronics Lab

L-T-P: 0-0-2

Credits: 2

Contact Hrs: 4 hrs/week

ISA Marks: 80

ESA Marks: 20

Total Marks: 100

Teaching Hrs: 48

Exam Duration: 2 hrs

Experiment Number	Experiments	No. of sessions
01	a) Design appropriate Signal conditioning for given sensor to be interfaced with controller.	02
	b) To study the frequency response of Active and Passive Low Pass Filter Experimentally acquire the strain and Present result using Industry Standard Graphical Programming Software and its associated hardware.	01 04
02	a) Measurement of physical Variables (eg. temperature, displacement) and displaying the data on serial monitor.	02
	b) Read Sensor data and display the data on a LCD using I2C protocol	02
03	a) Simulate 2 bit Registers, Counters and Arithmetic and Logical Unit(ALU)which are basic blocks of CPU	02
04	a) Development of Application using Model Based Design and implementation by interfacing Target Hardware (Arduino and Raspberry Pi) with Industry Standard Software.	05
05	a) Simulate basic programming concepts using PLC software.	02
	b) Building applications using PLC Hardware	02

Text Books

1. Tilak Thakur, Mechatronics, 1st edition, Oxford Higher Education, 2016.
2. Petruzella D Frank, “Programming Logic Controllers”, 3rd edition, Mc Graw Hill Education, 2010

References

1. W. Bolton, “Mechatronics”, 2nd edition , Pearson Ed, 2001

Manuals:

1. Mechatronics Lab Manual prepared by Lab-incharge.

Others:

Relevant Manuals and data sheets of different device/equipment manufacturers



B.E. (Mechanical Engineering)

5th and 6th Semester

Curriculum Structure & Syllabus

2019 – 23 Batch



B.E. (Mechanical Engineering) Curriculum structure & Syllabus 2019 – 23 Batch

Semester: V

No	Code	Course	Category	L-T-P	Credits	Contact Hours	ISA	ESA	Total	Exam Duration
-	19EMAB301	Numerical methods and Statistics (Diploma Students)	BS	3-0-1	4	4	50	50	100	3 hours
1	15EMEC301	Fluid Mechanics & Hydraulic Machines	PSC	4-0-0	4	4	50	50	100	3 hours
2	15EMEC304	Design of Machine Elements	PSC	3-1-0	4	5	50	50	100	3 hours
3	19EMEC301	Finite Element Methods	PSC	3-0-0	3	3	50	50	100	3 hours
4	15EMEE3XX	Program Elective - 1	PE	3-0-0	3	3	50	50	100	3 hours
5	19EMEP301	CAD Modeling & PLM Lab	PSC	2-0-2	4	6	80	20	100	2 hours
6	15EMEP303	Automation Lab	PSC	0-0-2	2	4	80	20	100	2 hours
7	19EMEP302	FEM Lab	PSC	0-0-1	1	2	80	20	100	2 hours
8	15EMEW301	Mini Project	PRJ	0-0-3	3	6	50	50	100	3 hours
				15-1-8	24	33				

ISA: In Semester Assessment, **ESA:** End Semester Assessment, **L:** Lecture, **T:** Tutorials, **P:** Practical. **PSC:** Program Specific Core, **PRJ:** Project work, **PE:** Program Elective

Electives:

Design Electives	Product Design Electives	Manufacturing Electives	Thermal Electives
Mechanical Vibration	Product Innovation	Advanced Machining Processes	Turbo Machines
15EMEE301	15EMEE304	15EMEE305	18EMEE303

CAE Electives	PLM Electives	Machine Learning
Advanced CAE – I	Programming	Advanced Statistics and Machine Learning
18EMEE301 (0-0-3) (80:20)	18EMEE302 (0-0-3) (80:20)	19EMEE302



B.E. (Mechanical Engineering) Curriculum structure & Syllabus 2019 – 23 Batch

Semester: VI

No	Code	Course	Category	L-T-P	Credits	Contact Hours	ISA	ESA	Total	Exam Duration
1	16EHSC301	Professional Aptitude & Logical Reasoning	PSC	3-0-0	3	3	50	50	100	3 hours
2	15EMEC305	Heat and Mass Transfer	PSC	3-0-0	3	3	50	50	100	3 hours
3	15EMEC302	Metrology and Quality Engineering	PSC	4-0-0	4	4	50	50	100	3 hours
4	15EMEE3XX	Program Elective - 2	PE	3-0-0	3	3	50	50	100	3 hours
5	15EMEE3XX	Program Elective - 3	PE	3-0-0	3	3	50	50	100	3 hours
6	15EMEP301	Metrology and Quality Engineering Lab	PSC	0-0-1	1	2	80	20	100	2 hours
7	18EMEW301	Minor Project	PRJ	0-0-6	6	6	50	50	100	2 hours
				16-0-7	23	24				

ISA: In Semester Assessment, **ESA:** End Semester Assessment, **L:** Lecture, **T:** Tutorials, **P:** Practical. **PSC:** Program Specific Core, **PRJ:** Project work, **PE:** Program Elective

Electives:

Design Electives	Product Design Electives	Manufacturing Electives	Thermal Electives
Failure Analysis in Design 15EMEE302	Product Design & Development 19EMEE303	Computer Integrated Manufacturing 15EMEE306	HVAC Systems 15EMEE308
Applications of Vibrations and Acoustics 19EMEE308			

CAE Electives	PLM Electives	E – Mobility Electives	Machine Learning
Advanced CAE – II 19EMEE304 (0-0-3) (80:20)	PLM Technical 19EMEE305 (0-0-3) (80:20)	Vehicle Structure and Design Optimization 19EMEE301 (0-0-3) (80:20)	Machine Learning Applications 19EMEE307 (0-0-3) (80:20)



B.E. (Mechanical Engineering) Curriculum structure & Syllabus 2019 – 23 Batch

V Semester Bachelor of Engineering (Mechanical Engineering)

Curriculum Content

Course Code: 19EMAB301

Course Title: Numerical methods and Statistics

L-T-P: 3-0-1

Credits: 04

Contact Hours: 6 hrs/week

CIE Marks: 50

SEE Marks: 50

Total Marks: 100

Teaching Hours: 40

Examination Duration: 3hrs

Unit I

1. Numerical Methods

8 hrs

Introduction to numerical methods. Roots of equations using Bisection Method, Newton- Raphson Method, Finite differences, Forward, Backward Operators. Newton Gregory forward and backward interpolation formulae. Newton's divided difference formula for an equal intervals. Numerical solution of first order ODE, Euler's and Modified Euler's method, Runge Kutta 4th order method. Implementation using python-programming

2. Matrices and System of linear equations

8 hrs

Introduction to system of linear equations, Rank of a matrix by elementary row transformations. Consistency of system of linear equation solution of system by (i) Direct methods-Gauss elimination, Gauss Jordan method (ii) Iterative methods- Gauss-Seidal method. Eigenvalues and Eigenvectors of a matrix. Largest Eigenvalue and the corresponding Eigenvector by power method. Implementation using python-programming.

Unit II

3. Curve fitting and regression

5 hrs

Introduction to method of least squares, fitting of curves $y = a + bx$, $y = ab^x$, $y = a + bx + cx^2$, correlation and regression.

4. Probability

9 hrs

Definition of probability, addition rule, conditional probability, multiplication rule, Baye's rule. (no proof) Discrete and continuous random variables- PDF-CDF- Binomial, Poisson and Normal distributions (Problems only).

Unit III

5. Sampling distributions

10 hrs

(a) Sampling, Sampling distribution, Standard error, Null and alternate hypothesis, Type-I and Type- II errors, Level of significance. Confidence limits for means (large sample).

(b) Testing of hypothesis for means. large and small samples and student's t- distribution and Confidence limits for means (small sample).

Text Books

1. Bali and Iyengar, A text book of Engineering Mathematics, 6ed, Laxmi Publications(p) Ltd, New Delhi,2003
2. Chapra S C and Canale R P, Numerical methods for Engineers, 5ed, TATA McGraw-Hill, 2007
3. Gupta S C and Kapoor V K, Fundamentals of Mathematical Statistics, 9ed, Sultan Chand & Sons, New Delhi, 2002



B.E. (Mechanical Engineering) Curriculum structure & Syllabus 2019 – 23 Batch

Reference Books:

1. Sastry S S, Introductory method for numerical analysis, 3ed, PHI, 2003.
2. J. Susan Milton, Jesse C. Arnold, Introduction to Probability and Statistics: Principles and Applications for Engineering and the Computing Sciences, 4th Ed, TATA McGraw-Hill Edition 2007.



B.E. (Mechanical Engineering) Curriculum structure & Syllabus 2019 – 23 Batch

Curriculum Content

Course Code: 15EMEC301

Course Title: Fluid Mechanics and Hydraulic machines

L-T-P: 4-0-0

Credits: 4

Contact Hrs: 4 hrs/week

ISA Marks: 50

ESA Marks: 50

Total Marks: 100

Teaching Hrs: 50

Exam Duration: 3 hrs

Unit I

1. Basic Concepts and Fluid properties

6 Hrs

Introduction, Application Areas of Fluid Mechanics, The No-Slip Condition, Classification of Fluid Flows, System and Control Volume, Properties of fluids, Energy and Specific Heats, Viscosity, Surface Tension and Capillary Effect.

Fluid statics: Pressure and its measurements, Hydrostatic forces on surfaces.

2. Fluid Kinematics

6 Hrs

Lagrangian and Eulerian Descriptions, Fundamentals of Flow Visualization, Streamlines and Stream tubes, Path lines, Streak lines, Timelines, Continuity equation, Velocity and acceleration of fluid flow, Velocity potential function and stream function

3. Mass, Bernoulli and Energy Equations

8 Hrs

Mass and Volume Flow Rates, Conservation of Mass Principle, Moving or Deforming Control Volumes, Mass Balance for Steady-Flow Processes, Mechanical Energy and Efficiency, Euler's equation of motion along a streamline, Bernoulli's equation, Navier-Stokes equation of motion, The momentum equation, General Energy Equation, Energy Analysis of Steady Flows.

Unit II

4. Flow in Pipes

6 Hrs

Laminar and Turbulent Flows, Reynolds Number, Boundary Layer, Laminar Flow in Pipes, Pressure Drop and Head Loss, Inclined Pipes, Turbulent Flow in Pipes, Major and Minor Losses, Flow Rate and Velocity Measurement.

5. Dimensional analysis

6 Hrs

Dimensions and Units, Dimensional Homogeneity, Non-dimensionalization of Equations, Dimensional Analysis and Similarity, Rayleigh's method and the Buckingham Pi Theorem, Dimensionless numbers.

6. Flow over Bodies

8 Hrs

Drag and Lift, Friction and Pressure Drag, Reducing Drag by Streamlining, Flow Separation, Drag Coefficients of Common Geometries, Drag Coefficients of Vehicles, Parallel Flow over Flat Plates, Friction Coefficient, Flow over Cylinders and Spheres, Lift, End Effects of Wing Tips, Lift Generated by Spinning

Unit III

7. Hydraulic Pumps

5 Hrs

Centrifugal pumps – Work done, Heads and efficiencies, Priming, specific speed, NPSH, Cavitation, Multistage centrifugal pumps.

Reciprocating pumps: Working principle, discharge, work done and power, slip, Air vessels.

8. Hydraulic Turbines

5 Hrs



B.E. (Mechanical Engineering) Curriculum structure & Syllabus 2019 – 23 Batch

Classification, Heads and efficiencies of turbines, Pelton, Francis and Kaplan turbines, Velocity triangles and work done, specific speed, Unit quantities, Draft tube, Characteristic curves.

Text Books:

1. Yunus A Cengel, John. M Cimbala: Fluid Mechanics – Fundamentals and Applications
2nd Edition, Mac Graw Hill Publications, 2017

Reference Books:

1. White F M: Fluid Mechanics, 8th Edn, McGraw Hill International Publication, 2015.
2. R.K. Bansal: Fluid Mechanics and Hydraulic Machines, 10th Edn, Laxmi Publications, 2018



B.E. (Mechanical Engineering) Curriculum structure & Syllabus 2019 – 23 Batch

Reference Books:

1. Machine Design: Hall, Holowenko, Laughlin (Schaum's Outlines series) Adapted by S.K. Somani, Tata McGraw Hill Publishing Company Ltd., New Delhi, Special Indian Edition, 2008.
2. Design of Machine Elements- K Ganesh Babu and K Srithar, McGRAW-HILL EDUCATION (INDIA) Pvt Ltd, Chennai, 2009
3. K. Mahadevan and Balaveera Reddy, Design Data Hand Book, CBS Publication, Fourth Edition. 2016.



B.E. (Mechanical Engineering) Curriculum structure & Syllabus 2019 – 23 Batch

Curriculum Content

Course Code: 19EMEC301

Course Title: Finite Element Methods

L-T-P : 3-0-0

Credits: 03

Contact Hrs: 3 hrs/week

ISA Marks: 50

ESA Marks: 50

Total Marks: 100

Teaching Hrs: 40

Exam Duration: 03

Unit I

1. Introduction to FEM:

7 Hrs

FEM paradigm : History, present/future, Research, Application, stress at a point, stress components on arbitrary plane, Equilibrium equations, compatibility equations, Generalized Hook's law, Plane stress and plain strain, principle of minimum potential energy and virtual work, RR method, FEM steps, Advantages , disadvantages and limitations.

2. Interpolation Functions For General Element Formulation :

8 Hrs

Discretisation process, types of elements, size of elements, location of node, node numbering scheme and mesh requirements in finite element method, Galerkin's methods with Numericals, polynomial form of interpolation functions, convergence requirements

Unit II

3. FEA analysis:

8 Hrs

Pascal triangle, shape functions (1D, 2D, LST, CST, Quad, Higher order elements), Stiffness matrix and its properties. Elimination approach, Penalty approach and Thermal effect based practical engineering problems.

4. Advanced FEA analysis:

7 Hrs

Multi-point constraint, Iso-parametric and Axi-symmetric elements. Practical aspects of industrial machine components, Field issues related to structural applications using higher order polynomials.

Unit III

6. Post processing techniques:

4 Hrs

Validate and interpret the results, Average and Un-average stresses, Special tricks for post processing, Design modification, CAE Reports

7. Experimental Validation and Data Acquisition:

4 Hrs

Strain gauge, Photo elasticity, Load cells, Torque Sensors/Transducers, Dynamic tests, Acceleration test, Fatigue life measurement, Natural Frequency measurements.

Text Books:

1. K. H. Huebner, D. L. Dewhirst, D. E. Smith and T. G. Byrom, The Finite Element Method for Engineers, 4th edition, Wiley, New York, 2001.
2. T. R. Chandruputala and A. D. Belegundu, Introduction to Finite Elements in Engineering, Third Edition, Prentice Hall of India, 2004.
3. Nitin Ghokale, Practical finite element analysis, Finite to infinite, 2008.

Reference Books:

1. Introduction to the Finite Element Method, by N. S. Ottosen and H. Peterson. Prentice-Hall, Englewood Cliffs, 1992.
2. S. S. Rao, Finite Element Method in Engineering , Fourth Edition, Elsevier Publishing, 2007.



B.E. (Mechanical Engineering) Curriculum structure & Syllabus 2019 – 23 Batch

Curriculum Content

Course Code: 19EMEP301	Course Title: CAD modelling and PLM Lab
L-T-P: 2-0-2	Credits: 4
ISA Marks: 80	ESA Marks: 20
Teaching Hrs: 180	Exam Duration: 2 hrs
	Contact Hrs:15
	Total Marks: 100

Content	Hrs
1. Sketcher	75
Brief introduction on Sketcher work bench environment Structure of users and saving of files. Exercises on SketchTools, Profile Tool bar and Constraint Tool bar: Generate the following 2D sketches and make them Iso-constrained	
2. Part Design	225
Exercise on 3d models using pad, slot, shaft, groove, hole ,rib and stiffener commands, cut revolve, Dress up commands like chamfer, fillets etc. (Multi-Sections Solid and Removed Multi-Sections Solid Commands)	
3. Generative shape design (GSD)	225
Exercises using GSD to generate complicated surfaces using sub tool bars: Extrude-Revolution, Offset Variable and Sweep Extrude, Revolve, Trim, Transformation and Fillet tools Exercises on Surfaces and Operations Tool bar: (Conversion of Surface model into Solid model)	
4. Assembly Design	150
Introduction to Assembly Design Work bench; Bottom-Up and Top-Down assembly approaches Invoking existing components into assembly work .Exercise to demonstrate Top-Down assembly approach.	
5. Drafting	150
Converting existing 3D models into 2d drawings with all relevant details, sectional views, sheet selection, indicating GD&T symbols and dimensioning.	
6. Enovia	75
Introduction to CATIA 3D experience PLM Import the existing CATIA 3D experience data and store in Search and identify the data located in 3D experience database Modify the data in any PLM process Sharing information with users Analyze and Identify impacts of modifications Save the modifications into database	

Reference Material:

1. Training material given by EDS on 3D experience



B.E. (Mechanical Engineering) Curriculum structure & Syllabus 2019 – 23 Batch

Curriculum Content

Course Code: 15EMEP303

Course Title: Automation Lab

L-T-P: 0-0-2

Credits: 2

Contact Hrs: 4 hrs/week

ISA Marks: 80

ESA Marks: 20

Total Marks: 100

Teaching Hrs: 48

Exam Duration: 2hrs

Unit – I

1. Automation Using Hydraulic Systems

8 Hrs

Introduction to Fluid Power, Advantages and application of Fluid Power, Types of Fluid Power System, Properties and Types of Fluids. Pascal's Law, Continuity Equations, Structure of Hydraulic Control System. The Source of Hydraulic Power: Pumps Pumping Theory, Pump Classification, Gear Pumps, Vane Pumps, Piston Pumps, Pump Selection, Hydraulic Actuators and Motors. Control Components In Hydraulic Systems: Symbolic representation as per ISO 1219 and ISO 5599. Directional Control Valves – Symbolic representation, Constructional features, pressure control valves, flow control valves.

Hydraulic Circuit Design (Simulation of circuits in Automation studio):Control of single and double – acting Hydraulic Cylinder, regenerative circuit, pump unloading circuit, Double pump Hydraulic system, Counter Balance Valve application, Hydraulic cylinder sequencing circuits, cylinder synchronizing circuits, speed control of hydraulic cylinder, accumulator circuits.

2. Automation using Pneumatic Systems

5 Hrs

Choice of working medium, characteristics of compressed air. Structure of Pneumatic control system. Linear cylinders, Simple Pneumatic Control: Direct and indirect actuation pneumatic cylinders, use of memory valve. Flow control valves and speed control of cylinders supply air throttling and exhaust air throttling, use of quick exhaust valve. Signal processing elements: Use of Logic gates – OR and AND gates pneumatic applications.

Unit – II

3. Automation Using Electronic Systems

5 Hrs

Control of hydraulic and pneumatic elements through PLC, Electro-hydraulic servo valve, Electro-pneumatic servo, Programmable automation controllers(PAC)

4. Robot programming & Control

5 Hrs

Programming languages description of ABB (RAPID Programming), Manual teaching, lead through teaching, (simple examples).



B.E. (Mechanical Engineering) Curriculum structure & Syllabus 2019 – 23 Batch

Sl. No	Name of Experiments	Duration (in hrs)
1	Characteristic Curve of Variable Displacement Hydraulic Pump	1
2	Carryout pressure intensification of a single-rod cylinder	1
3	Carryout Meter-in and Meter-out circuits using Single-rod cylinder and 4/2 DCV	1
4	Center Configuration of 4/3 DCV	1
5	Application of Regenerative Circuit	2
6	Direct control of Double Acting Cylinder	1
7	Indirect control of Double Acting Cylinder	1
8	Speed Control of Single Acting Cylinder	1
9	Position Dependent Control of a Double Acting Cylinder with Mechanical Limit Switches	1
10	Design of PLC system to control single acting cylinder, double acting cylinder, meter-in, meter-out and regenerative action.	2
11	To control extension/retraction with or without delay using ladder logic	2
12	Design of PLC system for, i. Clamping and punching operation (punching press machine) ii. Clamping and movement of tailstock (CNC machine)	2
13	To build and simulate arc/spot welding process in robotic environment	2
14	To build and simulate pick and place mechanism in robotic environment	2
15	Structured Enquiry experiment	2
16	Open ended experiment	2

Text Books :

1. Mikell.O. Groover , Automation, Production system and Computer Integrated Manufacturing, 2nd, PHI, 2002
2. Anthony Esposito, Fluid power with applications, 5th, Pearson Ed, 2000
3. Mikell P. Groover& Mitchell Weiss, Industrial Robotics, 2nd, Mc Graw H, 2003
4. William Bolton, Programmable Logic Controllers, 4th, Newnes, 2006

Reference Book:

1. S R Majumdar, Hydraulic systems, Principles and Maintenance, 5th, TMH, 2002
2. S R Majumdar, Pneumatic Systems, 2nd, TMH, 1995
3. Laboratory manual prepared by inhouse team.



B.E. (Mechanical Engineering) Curriculum structure & Syllabus 2019 – 23 Batch

Curriculum Content

Course Code: 19EMEP302

Course Title: FEM Lab

L-T-P: 0-0-1

Credits: 1

Contact Hrs: 2 hrs/week

ISA Marks: 80

ESA Marks: 20

Total Marks: 100

Teaching Hrs: 24

No of Sessions: 12

Exam Duration: 2 hrs

Category: Demonstration		No. of Lab. Sessions per batch (estimate)
1	Scientific Research Exposure (Research Education): Methods to search/extract Journal papers (Reputed journal paper), Referring papers, Drafting a paper. Introduction to ANSYS Workbench and familiarity. Real time Current/future field issues : Problem Identification	03
Category: Exercises		
Expt./Job No.	Experiment/job Details	No. of Lab. Sessions per batch (estimate)
1.	Static Structural analysis a) Uniform bar, b) Bracket, c) Machine Components	01
2.	Linear Buckling a) Columns & Struts (Different Boundary Conditions) b) Machine component	01
3.	Non-Linear Structural Analysis a) Geometric Nonlinearity b) Material Nonlinearity c) Contact Nonlinearity	02
4.	Dynamic Analysis (Modal/Harmonic/Transient Analysis) a) Beam (Different Boundary Conditions) b) Machine components	01
5.	Thermal Analysis a) Fins b) Heat Exchangers c) Machine component	01
6.	Drop Test & Impact Analysis a) Mobile drop test b) TV, Refrigerator etc.	01



B.E. (Mechanical Engineering) Curriculum structure & Syllabus 2019 – 23 Batch

7.	Optimization	01
8.	Model Test	01

Category: Structured Enquiry

Execute all the FEM Analysis modules which are dealt under the lab exercise.

Identify the component (Sub-assembly need have Minimum 3 to 4 components)

Start from scratch

- Measure the dimensions of component
- Generate the Solid Modeling of components with overall assembly (In any of the CAD Software)
- Import the model in neutral form to ANSYS Workbench
- Collection of data relevant to Material Properties
- Understand the physics of the problem (Working Principle with load's and boundary conditions)
- Interpretation of Results with conclusion.

Category: Open ended

1. Identify field issue pertaining to any component/product in today's industry.
2. Collect the information/literature on earlier worked project through external/internal search (Journal Paper/Patent/reports)
3. Comprehend the physics of the problem with working principle.
4. Prepare the abstract and apply to a national/international conference
5. Identify material properties, boundary conditions and load steps.
6. Carryout the analysis as per the FEA steps.
7. Provide engineering solutions to the identified sub assembly (deformation and stresses, material change, weight reduction, increasing load bearing capacity, fatigue life calculation, prediction of endurance limit of component and damage factor).
8. Prepare the draft on the worked out problem and apply to a national/international conference

Materials and Resources Required:

1. Books/References: Nitin Ghokale, Practical finite element analysis
2. Manuals: Sham Tickoo, ANSYS for Engineers and Designers



B.E. (Mechanical Engineering) Curriculum structure & Syllabus 2019 – 23 Batch

Curriculum Content

Course Code: 15EMEW301

Course Title: Mini Project

L-T-P: 0-0-3

Credits: 3

Contact Hrs: 3 hrs/week

ISA Marks: 50

ESA Marks: 50

Total Marks: 100

Teaching Hrs.: 36

Exam Duration: 3 hrs

The mini project is designed to help students develop practical ability and knowledge in reverse engineering. Every batch of 5 students are required to select an equipment such as Table fan, toy car, pump, bicycle etc. They have to dismantle the complete assembly and take measurements using various measuring instruments such as vernier calipers, micrometer, profile projector, 3D imager, portable CMM etc. Good sketches are to be made and converted into 3D part using 3D -Experience software. From then on the complete assembly in 3D, 2D assembly and BOM have to be prepared. 36 Hrs

The students will have to develop proficiency in 2D and 3D modeling. Special emphasis is given on incorporating Geometrical dimensioning & tolerancing on the 2D manufacturing drawings. He/she should be well versed in material selection based on applications and develop assembly and part drawings as per industry standard, In addition students have to include one innovative idea in their project. And incorporate the same in the design.

Individual team has to prepare final model in 2D and 3D with proper documentation for the entire project. Progress of the project work will be presented by student's periodically to the panel of reviewers

Phases of mini Project Work:

- Students in batches will first select a product to carry out reverse engineering.
- Dismantle the assembly into individual parts.
- Take dimensions and make good legible sketches.
- Carry out 3D models of all the parts In 3D experience software (Catia).
- Assemble the parts in software to see a complete assembly.
- Render the product and show it in an actual environment.
- Convert it into 2d assembly with ballooning and BOM.
- Part drawings to be converted into 2D manufacturing parts as per industry standards, with GD&T symbols wherever necessary.
- Students have to include an Innovative idea and incorporate the same in their project.
- Prepare a final detailed report explaining the various stages and give a presentation. as a team.

B.E. (Mechanical Engineering) Curriculum structure & Syllabus 2019 – 23 Batch

VI Semester Bachelor of Engineering (Mechanical Engineering)

Curriculum Content

Course Code: 16EHSC301

Course Title: Professional Aptitude & Logical Reasoning

L-T-P: 3-0-0

Credits: 3

Contact Hrs: 3 hrs/week

ISA Marks: 50

ESA Marks: 50

Total Marks: 100

Teaching Hrs: 40

Exam Duration: 3 hrs

Introduction:

Campus placements play a major role in shaping up the career goals of students. It is the dream of every engineering student to get placed in a top organization visiting their campus for recruitment. Recruiters visiting engineering colleges seek for candidates who are ready for the industry and have the etiquettes necessary for the corporate world.

During campus placements, recruiters test for an array of skill sets in their potential employees. In addition to being knowledgeable in their core subjects, students should also possess great aptitude, reasoning and soft skills.

Background of the Proposal for Open Elective on Professional Aptitude and Logical Reasoning

The National Board of Accreditation has proposed a 3-D framework for competencies for the development of a young budding technologist from an engineering institution. The three dimensions in this 3-D Framework are:

1. Attitudes and Perceptions
2. Meaningful Usage, Acquisition and Extension of Knowledge
3. Productive Habits of the Mind

In the second and third dimension some of the competencies mentioned are:

1. Ability to apply knowledge
2. Design skills
3. Problem solving skills
4. Analytical skills
5. Attention to details
6. Critical thinking
7. Creativity and idea initiation



B.E. (Mechanical Engineering) Curriculum structure & Syllabus 2019 – 23 Batch

8. Numerical ability

Objective of the Subject

At the end of this course a student will be able to improve some of the habits of the mind. The student will be able to:

1. Develop a deep sense of analysis towards solving a problem
2. Supplement his/her problem solving skills
3. Develop critical thinking
4. Boost his/her ability to work with numbers
5. Augment a student's attention to detail

Other Advantages of the Elective

This subject will help in developing the ability to solve situations and problems in exams such as Common Aptitude Test (conducted by the IIMs), GRE, GMAT and the aptitude part of GATE.

Process

PALR is 3 credit course offered to 3rd year engineering students of all branches except t architecture. After their 6th semester start facing campus interview. So as to make them placement ready / employable. The course has been introduced at a starch to all the departments like Automation and Robotic, Automobile, Biotechnology, Computer Science, Civil, Electrical and Electronics, Electronics and communication, Industrial and Production, Information Science, Instrumentation Technology & Mechanical.

Unit 1 focuses on the development of sense of analysis, numerical ability and arithmetical reasoning. It helps develops the ability of students to logically deduct inferences. Chapter 2 in this unit develops the problem solving skills and improves the ability to apply given information.

Unit 2 works on improving the attention to detail and critical reasoning/thinking of the student.

Unit 3 helps in the improvement of the student's ability to think creatively and generate new ideas. It also helps improve a student's design skills

B.E. (Mechanical Engineering) Curriculum structure & Syllabus 2019 – 23 Batch

Curriculum Content

Course Code: 15EMEC305

Course Title: Heat & Mass Transfer

L-T-P: 3-0-0

Credits: 3

Contact Hrs: 3 hrs/week

ISA Marks: 50

ESA Marks: 50

Total Marks: 100

Teaching Hrs: 40

Exam Duration: 3 hrs

Unit I

1. Introductory concepts and definitions

6 Hrs

Modes of heat transfer: Basic laws governing conduction, convection, and radiation heat transfer; Thermal conductivity; convective heat transfer coefficient; radiation heat transfer combined heat transfer mechanism, Mass transfer: Definition and terms used in mass transfer analysis, Fick's first law of diffusion. Boundary conditions of 1st, 2nd and 3rd kind
 Conduction: General 3D- heat conduction equation in Cartesian coordinate, discussion on 3-D conduction in cylindrical and spherical coordinates (No derivation). 1-D conduction through plane and composite walls. Overall heat transfer coefficient. Mathematical formulation

2. One dimensional Steady State Conduction

5 Hrs

Heat flow and temperature distribution in plane wall. Critical thickness of insulation, Thermal resistance concept. Steady state conduction in slab, cylinder and spheres with heat generation. Heat transfer in extended surfaces of uniform cross-section without heat generation [No Derivations], Fin efficiency and effectiveness. Numerical Problems

3. One-dimensional transient conduction

4 Hrs

Conduction in solids with negligible internal temperature gradient (Lumped system analysis), Use of Transient temperature charts (Heisler charts) for transient conduction in slab, long cylinder and sphere, Numerical Problems

Unit II

4. Concepts and basic relations in boundary layers

5 Hrs

Flow over a body velocity boundary layer, general expressions for drag coefficient and drag force, thermal boundary layer. general expression for local heat transfer coefficient; Average heat transfer coefficient; Nusselt number. Flow inside a duct, Numerical problems based on empirical relation given in data handbook.

Free or Natural Convection: Dimensional analysis for free convection- significance of Grashoff number, correlations for free convection over vertical, horizontal and inclined flat plates, vertical and horizontal cylinders and spheres.

5. Forced Convection

5 Hrs

Dimensional analysis for forced convection, significance of Reynolds, Prandtl, Nusselt and Stanton numbers. Correlations for hydrodynamically and thermally developed duct flows, Correlations for flow over flat plate, cylinder and sphere.

6. Heat Exchangers

5 Hrs

Classification of heat exchangers; overall heat transfer coefficient, fouling and fouling factor; LMTD, Effectiveness-NTU methods of analysis of heat exchangers. Numerical problems



B.E. (Mechanical Engineering) Curriculum structure & Syllabus 2019 – 23 Batch

Unit III

7. Condensation and Boiling

5 Hrs

Types of condensation (discussion only) Nusselt's theory for laminar condensation on a vertical flat surface [No Derivation]; use of correlations for condensation. Regimes of pool boiling pool boiling correlations [Theory].

8. Radiation heat transfer

5 Hrs

Thermal radiation; definitions of various terms used in radiation heat transfer; Stefan-Boltzmann law, Kirchhoff's law, Planck's law and Wein's displacement law. Radiation heat exchange between two parallel infinite black surfaces, between two parallel infinite gray surfaces, intensity of radiation and solid angle; Lambert's law; radiation heat exchange between two finite surfaces configuration factor or view factor. Numerical problems

Text Books:

1. Necati Ozisik - Heat transfer-A basic approach, 2ndEdn, Tata Mc Graw Hill, 2002
2. M.Tirumaleshwar – Fundamentals of Heat & Mass Transfer, 1st Edn, Pearson education 2009

Reference Books:

1. Yunus A. Cengel - Heat transfer, a practical approach, 4thEdn, Tata Mc Graw Hill, 2011
2. Frank Kreith, Raj M. Manglik, Mark S. Bohn, Principles of heat transfer, 7thEdn., Cengage Learning, 2011
3. Frank P. Incropera and David P. Dewitt- Fundamentals of Heat and mass transfer, 7thEdn, John Wiley, 2011
4. P.K. Nag - Heat and Mass transfer, 3rdEdn., Tata Mc Graw Hill, 2011



B.E. (Mechanical Engineering) Curriculum structure & Syllabus 2019 – 23 Batch

Curriculum Content

Course Code: 15EMEC302

Course Title: Metrology and Quality Engineering

L-T-P: 4-0-0

Credits: 4

Contact Hrs: 4 hrs/week

ISA Marks: 50

ESA Marks: 50

Total Marks: 100

Teaching Hrs: 50

Exam Duration: 3 hrs

Unit I

1. Fundamentals of Metrology

6 Hrs

Objectives of Metrology, Standards of physical quantities (mass, length, time, temperature, force, Velocity, density) types of standards, line and end standard, Slip gauges, Angle Gauges, Linear and Angular Measurements, Performance characteristics of measuring instruments, Calibration of instruments, The Process of Measurement, Significance of Measurement process, Methods of measurement, generalized measurement system, errors in measurement, gauges, comparators (mechanical and optical), Numerical

2. Dimensional Metrology

7 Hrs

Measurement of screw thread parameters, Terminology of screw threads, types of threads, Toolmakers microscope, profile projector, Gear terminology, Measurement of gear parameters. Gear tooth Vernier, Introduction to Surface Texture, Terminology as per Indian standard, Methods of measurement of surface finish, Working of Tomlinson surface meter, Taylor-Hobson Talysurf, Analysis of surface traces (RMS value, CLA value)

3. Limits, Fits and Gauges

7 Hrs

Introduction, limits, tolerance, and fits, types of fits, allowance. Hole basis and shaft basis systems, Indian standard system for limits and fits (IS 919-2709), types of gauges, Taylor's principle and gauge design. Numerical

Introduction to GD&T Terminology, Maximum Material control (MMC) & Least Material Control (LMC), Form and orientation tolerances in detail with application examples, Interpretation of drawings with GD & T and Exercises

Unit II

4. Advanced Metrology

7 Hrs

CMM(Coordinate Measuring Machine) : Co-ordinate Metrology, CMM configurations, hardware components, Software, Probe sensors, Displacement devices, applications

Laser Metrology : Free electron laser – optical alignment, measurement of distance – interferometry, reversible counting, refractive index correction, reversible counting, refractive index correction, surface topography and optical component testing

5. Analysis of Experimental Data

7 Hrs

Causes and Types of Experimental Errors, Error Analysis on a Common sense Basis, Uncertainty Analysis and Propagation of Uncertainty, Evaluation of Uncertainties for Complicated Data Reduction, Statistical Analysis of Experimental Data, Probability Distributions, The Gaussian or Normal Error Distribution, Comparison of Data with Normal Distribution, The Chi-Square Test of Goodness of Fit, Method of Least Squares, The Correlation Coefficient, Multivariable Regression, Standard Deviation of the Mean, Students t-Distribution

6. Quality Engineering

7 Hrs

Quality concepts, Dimensions of quality, Inspection, Objectives of Inspection Difference between Inspection & Quality Control, 7 QC tools, Statistical methods for quality control and improvement Basic Principles of Control charts, Control charts for variables, process capability and six sigma



B.E. (Mechanical Engineering) Curriculum structure & Syllabus 2019 – 23 Batch

Unit III

7. Control charts for Attributes and Acceptance sampling

5 Hrs

Control chart for fraction non-conforming, variable sample size, Number of defective chart, Control chart for Non conformities (defects) and Control chart for defects Average number of nonconformities. Types of sampling plans, operating characteristic (OC) curves

8. Introduction to TQM

5 Hrs

Basic approach, TQM framework, TQM principles-Leadership, Employee involvement, Empowerment, Team and Teamwork, Quality circles, Continuous process improvement – PDCA cycle, 5S, Kaizen – Supplier partnership – Partnering, TQM techniques- Bench marking, FMEA, QFD, TPM

Text Books:

1. Beckwith Marangoni and Lienhard, Mechanical Measurements, 6th Edition, Pearson Education 2007
2. Doebelin E.O., Measurements Systems, Applications and Design, 5th Edition McGraw –Hill,2003
3. Montgomery D. C., Introduction to Statistical Quality Control, 8th Edition John Wiley & Sons, Inc2019

Reference Books:

1. Holman J P, Experimental Methods for Engineers, 8th Edition McGraw-Hill Publications 2011
2. Connie. L. Dotson, Fundamentals of Dimensional Metrology, 6th Edition Cengage Publications 2015
3. Bosch J A, Giddings and Lewis Dayton, Marcel Dekker, Co-Ordinate Measuring Machines and Systems 2nd Edition CRC press 2015
4. Grant and Leavenworth, Statistical Quality Control, 7th Edition, McGraw-Hill Publications 1996



B.E. (Mechanical Engineering) Curriculum structure & Syllabus 2019 – 23 Batch

Curriculum Content

Course Code: 15EMEP301	Course Title: Metrology and Quality Engineering Lab	
L-T-P: 0-0-1	Credits: 1	Contact Hrs: 2 hrs/week
ISA Marks: 80	ESA Marks: 20	Total Marks: 100
Teaching Hrs: 24		Exam Duration: 3 hrs

Expt. No	Brief description about the Experiments	No. of Lab Slots
1	Introduction to the Laboratory-Standards of measurement for Linear and angular dimensions.	1
2	Analysis of performance characteristics of measuring instruments using Hypothesis testing.	1
3	Analysis of Repeatability and Reproducibility using gauge R& R test.	1
4	Measurement of Screw thread and Gear parameters, surface roughness	1
5	Machine Tool Alignment Test (Lathe, Drilling, Milling).	1
6	Measurement of Dimensions and GD&T parameters of given components using CMM (Coordinate Measuring Machine).	2
7	Reverse engineering of the given component by extraction of 2-Dimensions of the given part using 3D scanner.	1
8	Testing the goodness of fit for the given quality characteristics by Chi- Square test.	1
9	Construction of control chart for variables and Analysis of process capability for the different components manufacturing.	1
10	Construction and Analysis of control charts for defectives.	1
11	Open Ended experiment- Error analysis, Gauge Design.	1

Reference Books:

1. Montgomery D. C., Introduction to Statistical Quality Control, 8th Edition John Wiley & Sons, Inc 2019
2. Hume K.J. & Sharp G.H, Practical metrology , 1st Edition ELBS & Macdonald 1970
3. Juran J.M. & F.M. Gryna, Quality Planning & Analysis, 3rd Re edition TMH Publications 1993



B.E. (Mechanical Engineering) Curriculum structure & Syllabus 2019 – 23 Batch

Curriculum Content

Course Code: 15EMEE301

Course Title: Mechanical Vibrations

L-T-P: 3-0-0

Credits: 3

Contact Hrs: 3 hrs/week

ISA Marks: 50

ESA Marks: 50

Total Marks: 100

Teaching Hrs: 40

Exam Duration: 3 hrs

Unit I

1. Undamped Free Vibrations

6 Hrs

Introduction, Importance of vibration and its physical significance, Types of vibrations, Mechanical system components, Equivalent stiffness of spring combinations, Derivation of differential equation and Natural frequency for undamped free vibrations of single degree freedom systems, Newton's method and Energy method, Torsional vibrations, Transverse vibrations of beams.

2. Damped Free Vibrations

5 Hrs

Introduction, types of damping, study of response of single degree freedom viscous damped systems for cases of under damping, critical damping and over damping, Logarithmic decrement, Torsional system with viscous damping.

3. Whirling of Shafts

5 Hrs

Introduction, Whirling of shafts with and without damping, Discussion of speeds above and below critical speeds, Introduction to Noise.

Unit II

4. Forced Vibrations

7 Hrs

Introduction, Forced vibrations of single degree freedom viscous damped system due to harmonic excitation, Response of a rotating and reciprocating unbalance system, Support excitation, Vibration isolation and transmissibility.

5. Two Degree of Freedom Systems

7 Hrs

Introduction, Principal modes and Normal modes of vibration, Vibrations of undamped systems, Torsional vibrations, Forced harmonic vibration, Systems with damping, Co-ordinate coupling; applications in vehicle suspension, Dynamic vibration absorber.

Unit III

6. Multi Degree of Freedom Systems

5 Hrs

Introduction, Influence coefficients, Maxwell reciprocal theorem, Orthogonality principle, Matrix iteration method to determine all the natural frequencies of multi degree freedom systems, Dunkerley's method, Rayleigh's method.

7. Vibration Measurement and Condition Monitoring

5 Hrs

Introduction, Vibrometer and accelerometer, Frequency measuring instruments. Signal analysis: Spectrum analyzers, Dynamic testing of machines and structures, Experimental modal analysis, Machine maintenance techniques, Machine condition monitoring techniques, Vibration monitoring techniques.



B.E. (Mechanical Engineering) Curriculum structure & Syllabus 2019 – 23 Batch

Text Books:

1. Singiresu S. Rao, Mechanical Vibrations, 6th Edition, Pearson Education, 2018.
2. W.T. Thomson and Marie Dillon Dahleh, Theory of Vibrations with Applications, 5th Edition, Pearson Education, 2014.

Reference Books:

1. S. Graham Kelly, Mechanical Vibrations: Theory and Applications, Cengage Learning, SI Edition, 2012.
2. M. L. Munjal, Noise and Vibration Control, World Scientific Publishing Co, Pvt. Ltd., 2013



B.E. (Mechanical Engineering) Curriculum structure & Syllabus 2019 – 23 Batch

Curriculum Content

Course Code: **15EMEE302**

Course Title: **Failure Analysis in Design**

L-T-P : 3-0-0

Credits: 03

Contact Hrs: 3 hrs/week

ISA Marks: 50

ESA Marks: 50

Total Marks: 100

Teaching Hrs: 40

Exam Duration: 03

Unit – I

1. Introduction

8 Hrs

Study of Failure criteria and its importance, Role of failure prevention analysis in mechanical design, Modes of mechanical failure, Review of failure theories for ductile and brittle materials including Mohr's theory and modified Mohr's theory, Numerical examples.

2. Surface Failure

7 Hrs

Introduction, Surface geometry, Mating surface, Friction, Adhesive wear, Abrasive wear, Corrosion wear, Surface fatigue spherical contact, Cylindrical contact, General contact, Numerical examples.

Unit – II

3. Fatigue of Materials

5 Hrs

History of failure due to fatigue loads and development of fatigue failure, Concepts and terminology, High cycle and low cycle fatigue, Fatigue design models, Fatigue design methods, Fatigue design criteria, Fatigue testing, Fatigue fracture surfaces and macroscopic features, Fatigue mechanisms and microscopic features.

4. Stress-Life (S-N) Approach

6 Hrs

S-N curves, Statistical nature of fatigue test data, General S-N behavior, Different factors influencing S-N behavior, S-N curve representation and approximations, Constant life diagrams, Fatigue life estimation using S-N approach, Case study.

5. Strain-Life (ϵ -N) approach

5 Hrs

Monotonic stress-strain behavior, Strain controlled test methods, Cyclic stress-strain behavior, Strain based approach to life estimation, Determination of strain life fatigue properties, Mean stress effects, Effect of surface finish, Life estimation by ϵ -N approach.

Unit – III

6. Creep deformation

5 Hrs

The evolution of creep damage, primary, secondary and tertiary creep. Stress dependence of creep – power law dependence. Comparison of creep performance under different conditions – extrapolation and the use of Larson-Miller parameters. Creep-fatigue interactions. Numerical examples.

7. Buckling Analysis of rectangular plates

4 Hrs

Governing differential equation and boundary conditions, plate with all edges simply supported, plates with other boundary conditions, buckling under in-plane shear, post buckling analysis.

Text Books :

1. Ralph I. Stephens, Ali Fatemi, "Metal Fatigue in Engineering", John Wiley New York, 2nd edition, 2001.
2. Jack A Collins, Failure of Materials in Mechanical Design John Wiley & Sons, 1993.



B.E. (Mechanical Engineering) Curriculum structure & Syllabus 2019 – 23 Batch

3. Gambhir, M.L, Stability Analysis and Design of Structures, Springer-Verlag, 2004.

Reference Book:

1. Robert L. Norton, Pearson, “Machine Design- An Integrated Approach”, 2nd edition, 2000.



B.E. (Mechanical Engineering) Curriculum structure & Syllabus 2019 – 23 Batch

Curriculum Content

Course Code: 15EMEE303

Course Title: Piping systems Design

L-T-P: 3-0-0

Credits: 3

Contact Hrs: 3 hrs/week

ISA Marks: 50

ESA Marks: 50

Total Marks: 100

Teaching Hrs: 40

Exam Duration: 3 hrs

Unit - I

1. Introduction to piping 2 Hrs

Role of piping design engineers, Inputs and outputs of piping department, Scope and prospects in various industries, trends in piping industry.

2. Piping systems Basics 3 Hrs

Process Design, Block Flow diagrams, Process flow diagrams (PFD), Piping and Instrumentation Diagrams(P&ID's), Commonly used symbols in PFD and P & ID, Lines/signals, Piping: services, equipments, Fluid codes (process), Insulation.

3. Codes and Standards 2 Hrs

Standards, major organizations for standards, Design code-ASTM standards, ASME standards

4. Piping elements and symbolic representations 4 Hrs

Fittings used to join pipes, Fittings used to change pipe direction, Fittings used to join different sizes of pipes, Fittings used for various purposes –such as flange, gaskets, Fittings used for branching, special fittings used for Branching.

Unit - II

5. Valves 3 Hrs

Types of valves, control valves, safety valves, constructional features. Criteria for selection. Piping components, pressure relieving devices, constructional features, selection criteria. Gate valve, globe valve, ball valve, check valve, Butterfly valve, Diaphragm Valves, Needle valve, Piston valve, Knife Gate valve.

6. Process Equipments used in plants 3 Hrs

Pumps, storage tanks, vertical vessels, Horizontal dryer, Heat Exchangers, filters, blowers, Industrial boilers, steam turbines, compressors,

7. Process Instruments 3 Hrs

Pressure Gauge, Temperature Gauge, Level indicators, flow metering/indicators, Safety valves, breather valves.

8. Plot Plan Development 2 Hrs

Plot plan development, Basic data, steps to be considered while developing the plot plan. Layout of Liquid storage, Layout considerations for explosive tank farm, Layout of gas Storage.



B.E. (Mechanical Engineering) Curriculum structure & Syllabus 2019 – 23 Batch

Unit - III

9. Piping Layouts 3 Hrs

Introduction to P&I Diagrams, process flow diagrams, standard symbols and notations. Introduction to various facilities required. Guidelines for plot plan/ plant layout. Introduction to equipment layout, piping layout, piping isometrics and bill of material. Typical piping system layout considerations. Piping arrangements, clearances and access, pipe rack, valve location, tower piping,

10. Conversion of orthographic to isometric view 3 Hrs

Introduction to isometric view, symbolic representation of elements in isometric environment, Pipe layout exercises,

11. Plant Layout Design software - LAB 12 Hrs

Introduction to CADMATIC Software, 15 most important shortcut commands and practice Construction of Pipe line Route, 4 (Pipe D)(refer to the drawing in the next subsequent pages), Construction of Pipe line Route 6 (Pipe F) , Construction of Pipe line Route 8.(Pipe H) , Construction of Pipe line Route 9(Pipe I), Construction of Pipe line Route 11 (Pipe K), Construction of Pipe line Route No 14 (Pipe M). Construction of Pipe line Route No 3, 1, 2, (Pipe C, A, B) , Construction of Pipe line Route No 5 ,7, 10,(Pipe E, G, J) , More features of software namely ladder, pipeline rack, and cable tray construction. Construction of all the pipeline network and Practice session

Text Books:

1. Ed. Baushbacher, Roger Hunt, Process Plant Layout and Piping Design, 1993, Prentice Hall , 1993

Reference Book :

1. Suvidya Institute of Technology Pvt. Ltd, Manual on Piping Engineering, Suvidya Institute of Technology Pvt. Ltd. Mumbai
2. Yunus A. Cengel, John M. Cimbala,, Fluid Mechanics Fundamental and Applications, 2nd, MGH,, 2006

B.E. (Mechanical Engineering) Curriculum structure & Syllabus 2019 – 23 Batch

Curriculum Content

Course Code: 15EMEE304

Course Title: Product Innovation

L-T-P: 2-1-0

Credits: 3

Contact Hrs: 4 hrs/week

ISA Marks: 50

ESA Marks: 50

Total Marks: 100

Teaching Hrs: 24

Tutorial Hrs : 24

Exam Duration: 3 hrs

Unit I

1. Technological Innovation:

8 Hrs

Introduction, Sources of Innovation, Types and Patterns of Innovation, drivers for innovation, Innovation enablers, Innovation culture, Innovation Metrics, Challenges for Innovation, innovation Success stories, New product Innovation Process, Innovation progression, growth through Innovation, Idea generation, Idea Screening, Proof of Concept, team formation, Reality check.

2. Customer Analysis:

6 Hrs

Customer Needs Analysis, Big Problem, W's of Customers, Target Customer Segments, Consumer customer segmentation, Customer Value realization, Capture Customer Needs, Classification of needs, Standards Battles and Design dominance, Timing of entry

Unit II

3. Market Analysis: Innovation Opportunity, Environmental Analysis,

9 Hrs

Fore-sighting, S-curve for technology and consumer, Porters 5 forces, market Capacity, Evaluation of opportunity, Volume for casting, Competition Analysis: W's of Competition, Tools to compare products, sources for Competitive information.

4. Tools for Innovation: 5 Phases, Divergent and Convergent thinking, demographics, Contextual maps, Progression curve, Janus Cone, Generational arcs, Go to Market With innovation

7 Hrs

Unit III

5. Innovation Processes and Methods:

10 Hrs

TRIZ – Theory of innovative problem solving, ToC – Theory of Constraints, 8 Steps of Innovation

References:

1. Playbook for strategic foresight and Innovation – Stanford University
2. 8 Steps of Innovation – R. T. Krishnan and V. Dabholkar
3. TRIZ and ToC – Handouts
4. A Unified Innovation Process Model for Engineering Designers and Managers (In Design Thinking) Skogstad, P., Leifer, L. edited by Meinel, C., Leifer, L., Plattner, H. Springer Berlin Heidelberg. 2011: 19–43



B.E. (Mechanical Engineering) Curriculum structure & Syllabus 2019 – 23 Batch

Curriculum Content

Course Code: 19EMEE303	Course Title: Product Design & Development	
L-T-P: 2-1-0	Credits: 3	Contact Hrs: 5 hrs/week
ISA Marks: 50	ESA Marks: 50	Total Marks: 100
Teaching Hrs: 24	Tutorial Hrs : 24	Exam Duration: 3 hrs

Unit – I

1. VoC to Product Specifications

QFD methods to develop product specification from VoC

Concept development methods – Functional Analysis, Mock-ups, Concept selection methods (Pugh Matrix, Customer Focus Groups, Delphi method), Gap analysis, Rapid prototyping techniques, First Order analysis of concepts.

2. Design Methods

1. Knowledge based engineering design techniques
 2. Design Optimization techniques, Robust design methods overview,
 3. Design for Six Sigma (Quality) methodology
 4. Design for “X” –(X = Cost, Manufacturability, Assembly, Sustainability)
 5. CAE led design techniques
 6. Bio-inspired design
- 12 Hrs

Unit -II

3. Product Development Process

Program Management, Design and functional review methods (DFMEA), Assembly process and virtual builds, Quality goals and control plans

4. Product Verification and Validation

Load goals and duty cycle definition, Reliability and durability goals, Virtual prototyping techniques, Accelerated product verification methods

6 Hrs

Unit - III

5. Product family management

Product lifecycle management; Evolution of product models and families, Modeling of product family lifecycle, Product Strategy, Product market positioning, Product positioning – psychological, Brand, customer segment.

6. Technology management

Technology management methods, Technology as a competitive tool, Critical Component Development Process, Technology Development Process

6 Hrs



B.E. (Mechanical Engineering) Curriculum structure & Syllabus 2019 – 23 Batch

Reference Book:

1. Karl Ulrich and Steven Eppinge, Product Design and Development
2. Kenneth B. Kahn, The PDMA Handbook of New Product Development, Second Edition
3. Six Sigma Guide



B.E. (Mechanical Engineering) Curriculum structure & Syllabus 2019 – 23 Batch

Text Books:

1. C. Sujatha, Vibration and Acoustics, Tata McGraw-Hill Education, 2010
2. Singiresu S. Rao, Mechanical Vibrations, 6th Edition, Pearson Education, 2018.

Reference Books:

1. M. L. Munjal, Noise and Vibration Control, World Scientific Publishing Co, Pvt. Ltd., 2013
2. Bruel and Kjaer, Mechanical Vibration and Shock Measurements, 2nd Edition, Larsen & son, 1984.

B.E. (Mechanical Engineering) Curriculum structure & Syllabus 2019 – 23 Batch

Curriculum Content

Course Code: 15EMEE305

Course Title: Advanced Machining Processes

L-T-P: 3-0-0

Credits: 3

Contact Hrs: 3 hrs/week

ISA Marks: 50

ESA Marks: 50

Total Marks: 100

Teaching Hrs: 40

Exam Duration: 3 hrs

Unit – I

1: Introduction to Advanced Machining Processes

3 Hrs

Introduction to new methods of production; Need and Capability analysis of various processes, Classification and Selection of Non-Traditional Machining Technologies, Hybrid Processes, Cases.

2: Mechanical Advanced Machining Processes

12 Hrs

Abrasive Jet Machining (AJM): Machining setup, parametric analysis, Process capabilities. Ultrasonic machining (USM): Machining setup, Mechanics of Cutting - Model Proposed by Shaw, Parametric analysis, Process capabilities, Abrasive Flow Machining, Magnetic Abrasive Finishing. Water jet cutting (WJC).

Unit – II

3: Thermal Advanced Machining Processes

8 Hrs

Plasma Arc Machining (PAM): Working System, Elements of PAM, Process Performance, PAM Parameters, Process Characteristics, Safety Precautions, Electric Discharge Machining (EDM): Working Principle, Analysis, Process Variables, Process Characteristics, Applications

4: Thermo-electric Advanced Machining Processes

7 Hrs

Electron Beam Machining (EBM): Working Principle, Process Parameters, Characteristics of The Process, Application of EBM, Laser Beam Machining (LBM): Working Principle, Types of Laser, Process Characteristics, Applications, Ion Beam Machining (IBM): Working Principle, Process Parameters, Applications

Unit – III

5: Chemical Machining Processes

6 Hrs

Chemical Machining: Elements of process, Process Characteristics of CHM. Electro Chemical Machining: Elements and Characteristics and Theory of ECM

6: Hybrid Processes

5 Hrs

Electro chemical grinding (ECG), Electrochemical spark machining (ECSM), electrochemical arc machining (ECAM) and electro discharge abrasive grinding (EDAG).



B.E. (Mechanical Engineering) Curriculum structure & Syllabus 2019 – 23 Batch

Text Books:

1. Jain V. K. “Advanced Machining Processes”, Allied Publishers, Private Limited.
2. Pandey P. C. and Shan H. S., “Modern Machining Processes”, TATA McGraw Hill Publishing Company Limited, New Delhi.

Reference Book:

1. HMT, “Production Technology”, TATA McGraw Hill.
2. Adithan M, “Modern Machining Methods”, S. Chand & Company, New Delhi.



B.E. (Mechanical Engineering) Curriculum structure & Syllabus 2019 – 23 Batch

Curriculum Content

Course Code: 15EMEE306

Course Title: Computer Integrated Manufacturing

L-T-P: 3-0-0

Credits: 3

Contact Hrs: 3 hrs/week

ISA Marks: 50

ESA Marks: 50

Total Marks: 100

Teaching Hrs: 40

Exam Duration: 3 hrs

Unit – I

1: Manufacturing operations:

8 Hrs

Production system facilities, manufacturing support systems, automation in production systems, manual labor in production systems. Automation principles and strategies, manufacturing industries and products, product/production relationships, production concepts and mathematical models, costs of manufacturing operations

2: Manufacturing systems:

8 Hrs

Components, classification, manufacturing process functions, single station manufacturing cells, applications. Group Technology Part families, classification and coding, production flow analysis

Unit – II

3: Cellular Manufacturing, Flexible Manufacturing Systems:

5 Hrs

Cellular manufacturing quantitative analysis in cellular manufacturing, FMS components, planning and implementation, quantitative analysis of FMS

4: Material handling and storage:

5 Hrs

Material handling equipment, considerations in material handling system design, principles of material handling, material transport systems, storage systems: automated storage systems, automatic data capture, automatic identification methods

5: PLM and IIoT:

5 Hrs

Areas of Product Life cycle Management (PLM), phases of product life cycle and technologies, benefits of PLM.

Definition of Industrial Internet of Things (IIoT), Evolution, Enablers for IIoT platform, drivers, Benefits, protocols, challenges, future

Unit – III

6: Robot fundamentals:

5 Hrs

Robot anatomy and related attributes, classification, robot control systems, end effectors, sensors in robotics, robot programming

7: Robot kinematics:

5 Hrs

Matrix representation, Homogeneous transformation matrices, Representation of transformations, Inverse transformation matrices, forward and inverse kinematics of robots, D-H representation of forward kinematic equations, degeneracy and dexterity



B.E. (Mechanical Engineering) Curriculum structure & Syllabus 2019 – 23 Batch

Text Books:

1. Grover M.P., “Automation, Production Systems and Computer Integrated Manufacturing”, Prantice Hall, India.
2. Chris McMahon & Jimmie Browne, “CAD & CAM Principles”, Practice & Mfg. Mngt.’, Pearson Education.

Reference Books:

1. Radhakrishnan P., “CAD/CAM/CIM”, New Age International Private Limited.
2. Zeid Ibrahim, “CAD/CAM”, McGraw Hill International.
3. Rao P.N., ‘CAD/CAM Principles and Applications’, Tata McGraw-Hill.
4. Vajpayee S. K., “Principles of CIM”, Prentice Hall of India.
5. Saeed B. Niku, “Introduction to Robotics”, Prentice Hall of India.

B.E. (Mechanical Engineering) Curriculum structure & Syllabus 2019 – 23 Batch

Curriculum Content

Course Code: 18EMEE303	Course Title: Turbo machines
L-T-P: 3-1-0	Credits: 3
ISA Marks: 50	ESA Marks: 50
Teaching Hrs: 50	Exam Duration: 3 hrs
	Contact Hrs: 3 hrs/week
	Total Marks: 100

Unit – 1

1. Principles of Turbo Machinery 5 Hrs

Definition of turbo machine, Comparison with positive displacement machine, Classification; Application of first and second law to turbo-machines, Efficiencies. Dimensionless parameters and their physical significance, Effect of Reynolds number, Specific speed, Illustrative examples on dimensional analysis and model studies.

2. Energy Exchange In Turbo Machine 5 Hrs

Euler Turbine equation, Alternate form of Euler turbine equation-components of energy transfer, Degree of reaction, General Analysis of a turbo machine-effect of blade discharge angle on energy transfer and degree of reaction, General analysis of centrifugal pumps and compressors-effect of blade discharge angle on performance, Theoretical head-capacity relationship.

3. General Analysis of Turbo Machines 6 Hrs

Axial flow compressors and pumps-general expression for degree of reaction, velocity triangles for different values of degree of reaction, General analysis of axial and radial flow turbines-utilization factor and degree of reaction, Condition for maximum utilization factor-optimum blade speed ratio for different types of turbines.

Unit – II

4. Compressible Flow Fundamentals 5 Hrs

Energy and momentum equations for compressible fluid flows, various regions of flows, reference velocities, stagnation state, velocity of sound, critical states, Mach number, critical Mach number, types of waves, Mach cone, Mach angle, effect of Mach number on compressibility

5. Centrifugal Compressors 6 Hrs

Stage velocity triangles, slip factor, power input factor, Stage work, Pressure developed, stage efficiency and surging, stalling and prewhirl. Expression for pressure ratio developed in a stage, work done factor, efficiencies, Problems.

6. Axial flow Compressors

Axial Flow Compressors: Basic operations, elementary theory, factors affecting stage pressure ratio, Blockage in the compressor annulus, degree of reaction, three-dimensional flow, design process, blade design, calculation of stage performance, compressibility effects, off-design performance.



B.E. (Mechanical Engineering) Curriculum structure & Syllabus 2019 – 23 Batch

Unit – III

7. Flow through Variable Area Ducts 4 Hrs

Isentropic flow through variable area ducts, T-s and h-s diagrams for nozzle and diffuser flows, area ratio as a function of Mach number, mass flow rate through nozzles and diffusers, effect of friction in flow through nozzles.

8. Steam Turbines 4 Hrs

Classification, single stage impulse turbine, condition for maximum blade efficiency, stage efficiency. Compounding-need for compounding, method of compounding, impulse staging- condition for maximum utilization factor for multi stage turbine with equiangular blades, effect of blade and nozzle losses, Reaction turbine, Parson's reaction turbine, condition for maximum blade efficiency, reaction staging, Problems on single stage turbines only.

Text Book:

1. Shepherd D.G., Principals of Turbo Machinery, Macmillan Publishers, 1st Edn. 1964
2. Yadav R., (2007) 'Steam & gas turbines and power plant engineering', Central Publishing House Allahabad, Vol. 1,
3. S. M. Yahya, Turbines, Compressors & Fans, Tata McGraw Hill Co. Ltd., 2nd edition, 2002.
4. E Rathakrishnan, Gas Dynamics, PHI- 2nd edition, 2009.

Reference Book :

1. Kadambi V. Manohar Prasad, An Introduction to Energy Conversion, Vol-III Turbo Machinery, New Age International, 1st Edn, 2006.
2. Saravanamuttoo H.I.H, Rogers G.F.C., Cohen H, Gas Turbine Theory, 5th edn., Pearson Education, 2006.



B.E. (Mechanical Engineering) Curriculum structure & Syllabus 2019 – 23 Batch

Curriculum Content

Course Code: 15EMEE308

Course Title: HVAC Systems

L-T-P: 3-0-0

Credits: 3

Contact Hrs: 3 hrs/week

ISA Marks: 50

ESA Marks: 50

Total Marks: 100

Teaching Hrs: 40

Exam Duration: 3 hrs

Unit – I

1: Introduction to HVAC Systems and Psychrometry

5 hrs

Purpose, applications, definition and components of air conditioning - Need and methods of ventilation. Evolution of air properties and psychrometric chart - Basic processes such as sensible heating/cooling, humidification/dehumidification and their combinations, steam and adiabatic humidification, adiabatic mixing, etc. - Bypass factor and Sensible heat ratio, Numerical problems.

2: Human Comfort, Summer and winter AC

5 hrs

Heat transfer from body, convection, radiation, conduction, evaporation, clothing resistance, activity level - Concept of human comfort - Thermal response - comfort factors - Environmental indices - Indoor air quality. - Simple summer AC process, Room sensible heat factor, Coil sensible heat factor, ADP - Precision AC - Winter AC.

3: AC Systems and Equipment

6 hrs

Classification of air conditioning systems, Filters, types, efficiency – Fan laws, cooling coils and heating coils, sizing and off design performance - Cooling and dehumidifying coil, dry and wet, sizing, performance.

Unit – II

4: Heat Transfer

3 hrs

Heat transfer in wall and roof, sol-air temperature, insulation, cooling load temperature difference - Fenestration, types of glass, sun shade, shading coefficient, maximum radiation, cooling load factor

5: Cooling load and heating load estimation

7 hrs

Thermodynamics of human body and mathematical model, Human comfort chart, Design conditions, outdoor, indoor - External load, wall, roof, glass - Internal load, occupancy, lighting, equipments - Ventilation, air quantity, loads - Load estimation methods. Vapour transfer in wall, vapour barrier, load estimation basics.

Introduction to AutoCAD REVIT software

6: Air distribution, diffusion and Ventilation

6 hrs

Ducts, types, energy equation for pipe flow, friction chart, methods of sizing, air distribution systems, ADPI, outlet/inlet selection.

Need, threshold limits of contaminants, estimation of ventilation rates, decay equation, air flow round buildings, Natural, wind effect, stack effect, combined effect - Mechanical, forced, exhaust, combined - Displacement ventilation

Unit – III

7: Ventilation system design

4 hrs

Exhaust ducts, filters, blowers, hoods, chimney, etc.

8: Industrial ventilation

4 hrs

Steel plants, car parks, plant rooms, mines, etc.



B.E. (Mechanical Engineering) Curriculum structure & Syllabus 2019 – 23 Batch

Text Book:

1. Faye C. McQuiston, Jerald D. Parker, Jeffrey D. Spitler, Heating, Ventilating and Air Conditioning: Analysis and Design, 6th Edition, July 2004,
2. W P Jones, Air Conditioning Engineering ELBS 3rd edn Edward Arnold (Publishers) Ltd. London.

Reference Book:

2. Harris, Modern Air Conditioning Practice 3rd Edn McGraw Hill Book Company
3. S. N. Sapali, Refrigeration and air conditioning 2nd Edn, PHI learning pvt ltd, Delhi 2016
4. C P Arora, Refrigeration and air conditioning 3rd edn



B.E. (Mechanical Engineering) Curriculum structure & Syllabus 2019 – 23 Batch

Curriculum Content

Course Code: 18EMEE301

Course Title: Advanced CAE - I

L-T-P: 0-0-3

Credits: 3

Contact Hrs: 6 hrs/week

ISA Marks: 80

ESA Marks: 20

Total Marks: 100

Teaching Hrs: 80

Exam Duration: 2 hrs

- 1. Introduction** to Finite Element Method and Altair Hyper works. 3 Hrs
- 2. Hypermesh workbench** 6 Hrs
Getting started with Hypermesh
Interacting with panels
- 3. Geometry Clean up - Theory** 12 Hrs
Tools used to geometry clean up
(Edge edit, Create Surface and Surface edit, Line and Line Edit, Delete)
Theory and Demo Exercise – 04 No
- 4. 2-D mesh Explanation -Theory** 18 Hrs
Auto mesh and Different types of auto mesh
Types of 2 D mesh (Ruled, Spline, Rotate.....)
Quality Parameters checking.
Normal's and Edge Checking and adjusting.
Theory and Demo Exercise – 04 No
- 5. 3-D mesh Explanation -Theory** 18 Hrs
Volume mesh Creation
Types of 3 D mesh (Hexa Penta Type, Tetra mesh.....)
Quality Parameters checking.
Normal's and Edge Checking and adjusting.
Theory and Demo Exercise - 03 No
- 6. 1-D mesh Explanation -Theory** 9 Hrs
Creation of 1 D elements (Bar, Beam Mass....)
Creation of Rigid elements (Rbe2 and Rbe3)
Creation of Weld elements between two adjacent components
Demo Exercise - 03 No
- 7. Execute Linear Static Analysis** using optistruct solver 3 Hrs
Theory and Demo Exercise - 01 No
Assignment - 01 No
- 8. Perform Buckling Analysis** using optistruct solver 2 Hrs
Theory and Demo Exercise - 01 No
- 9. Carryout Modal Analysis** using optistruct solver 2 Hrs
Theory and Demo Exercise - 01 No
- 10. Analyze Thermal Analysis** using optistruct solver 2 Hrs
Theory and Demo Exercise - 01 No
- 11. Execute Non Linear Analysis** using optistruct solver 5 Hrs



B.E. (Mechanical Engineering) Curriculum structure & Syllabus 2019 – 23 Batch
(Geometry, Material and Contact Non-Linear)
Theory and Demo Exercise - 03 No

Reference Books:

1. Nitin S Ghokale , Practical Finite Element Analysis , 3rd Edition, Finite to Infinite, 2015.



B.E. (Mechanical Engineering) Curriculum structure & Syllabus 2019 – 23 Batch

Curriculum Content

Course Code: 19EMEE304

Course Title: Advanced CAE- II

L-T-P: 0-0-3

Credits: 3

Contact Hrs: 6 hrs/week

ISA Marks: 80

ESA Marks: 20

Total Marks: 100

Teaching Hrs: 80

Exam Duration: 2 hrs

Experiment wise plan

List of exercises planned to meet the requirements of the course.

Serial No.	Details	Category	No. of Sessions
1.	Finite Element Methods: A conceptual introduction, Failure criteria of materials	Demonstration	01
2.	Ansys workbench > Getting started with Ansys > Interacting with panels <u>Case Study:</u> Beam, Pneumatically Actuated PDMS Fingers, Spur Gears and Micro gripper etc.	Exercise/Tutorial	02
3.	Design Modeler Geometry clean-up tools: De-features, Projection. <u>Case Study:</u> Bar, Beam, Triangular plate.	Exercise/Tutorial	02
4.	Case study on One dimensional/Two dimensional/Three dimensional components > 1D: Rod, Bar, Link, Spring, Beam > 2D: Bellows Joints, Gearbox etc. > 3D: Beam bracket, Cover of pressure cylinder, Lifting fork and LCD display support.	Exercise/Tutorial	03
5.	Convergence study in FEA Quality parameters for 1D/2D/3D elements, Convergence Study of 2D and 3D Solid Elements > Pneumatic fingers > Cover of pressure cylinder	Exercise/Tutorial	03
6.	Case study on Static structural analysis > Refrigerator handle > Shell –Automotive panels (Fender, Bonnet) Assignments > Wooden chair > Crain hook	Exercise/Tutorial	03



B.E. (Mechanical Engineering) Curriculum structure & Syllabus 2019 – 23 Batch

7.	Case study on Modal analysis <ul style="list-style-type: none">➤ Compact disk➤ Machine tool structures- Bed, Column.➤ Guitar string Assignments <ul style="list-style-type: none">➤ Human skeleton➤ Car chassis➤ Engine housing	Exercise/Tutorial	02
8.	Case study on Structural dynamic Analysis <ul style="list-style-type: none">➤ Lifting fork➤ Ball and rod➤ Base of compressor in Refrigerator Assignments <ul style="list-style-type: none">➤ Leaf spring➤ Steering wheel➤ Railway track	Exercise/Tutorial	03
9.	Case study on Non linear analysis Geometry, Material and Contact analysis <ul style="list-style-type: none">➤ Fisher rod(Geometry)➤ snap lock(Material)➤ Translational joint(Contact) Assignments <ul style="list-style-type: none">➤ Gasket(Contact)➤ Advanced metal plasticity(Material)➤ Visco-plasticity(Material)	Exercise/Tutorial	04
10.	Case study on Explicit Dynamics <ul style="list-style-type: none">➤ High-Speed Impact : Bird Crash	Exercise/Tutorial	01
11.	Case study on Buckling and Stress stiffening <ul style="list-style-type: none">➤ 3D Truss➤ Beam Bracket Assignments <ul style="list-style-type: none">➤ Machine column(Milling/ Drilling)➤ Dovetail guide way	Exercise/Tutorial	02
12.	Case study on Thermal analysis Steady state thermal analysis Transient thermal analysis <ul style="list-style-type: none">➤ Heat exchanger➤ Fin Assignments <ul style="list-style-type: none">➤ PCB Panel➤ Telephone/power cables	Exercise/Tutorial	02
13.	Case study on Fatigue Analysis Stress based approach Strain based approach <ul style="list-style-type: none">➤ Connecting rod➤ Fin Assignments <ul style="list-style-type: none">➤ Radial tire➤ Battery of laptop/mobile	Exercise/Tutorial	04
14.	Case study on Sub-Modeling <ul style="list-style-type: none">➤ Motor cover	Demo	01
15.	Case study on Multi Body Dynamics (MBD)	Exercise/Tutorial	03



B.E. (Mechanical Engineering) Curriculum structure & Syllabus 2019 – 23 Batch

	<ul style="list-style-type: none">➤ Applications of Four bar mechanism➤ Sun planet gear mechanism Assignments <ul style="list-style-type: none">➤ Power cylinder in a diesel engine➤ Screw jack		
16.	Analysis of Composite <ul style="list-style-type: none">➤ Applications on automotive components(fender, hood, dashboard)➤ Applications on aerospace components (wings, window panels, tale) Assignments <ul style="list-style-type: none">➤ Polymer matrix composite➤ Metal matrix composite	Exercise/Tutorial	01
17.	Case study on Optimization <ul style="list-style-type: none">➤ Triangular plate➤ Flexible gripper Assignments <ul style="list-style-type: none">➤ Electronic Fuse➤ Radiating system➤ Tractor trailer	Exercise/Tutorial	01
18.	Case study on Couple Field Analysis <ul style="list-style-type: none">➤ Electromagnetic-thermal (Induction heating)➤ Electromagnetic-thermal-structural (Peltier coolers)➤ Electrostatic-structural, electrostatic-structural-fluidic (MEMS)	Demo	02

Text Book :

1. Nitin Ghokale, Practical finite element analysis, Finite to infinite, 2008.

Reference Book :

1. Chen, Xiaolin_ Liu, Yijun-Finite Element Modeling and Simulation with ANSYS Workbench-CRC Press (2014)
2. Erdogan Madenci, Ibrahim Guven (auth.)-The Finite Element Method and Applications in Engineering Using ANSYS®-Springer US (2015)
3. Barbero, Ever J.-Finite Element Analysis of Composite Materials Using ANSYS®-CRC Press (2013)



B.E. (Mechanical Engineering) Curriculum structure & Syllabus 2019 – 23 Batch

Curriculum Content

Course Code: 18EMEE302

Course Title: Programming

L-T-P: 0-0-3

Credits: 3

Contact Hrs: 6 hrs/week

ISA Marks: 80

ESA Marks: 20

Total Marks: 100

Teaching Hrs: 74

Exam Duration: 2 hrs

Introduction to java:

6 Hrs

History and Features of Java, Internals of Java Program, Difference between JDK, JRE and JVM, Variable and Data Type, Naming Convention, JDK installation and configuration

OOP Concepts:

12 Hrs

Advantage of OOPs, Object and Class, Method Overloading, Constructor, static variable, method and block, this keyword, Package and Access Modifiers, Encapsulation, Object class, Java Array, call by Value and Call by Reference, Inheritance, Method Overriding, final keyword, Runtime Polymorphism, static and Dynamic binding, Abstract class and Interface, down casting with instance of operator.

String Handling:

5 Hrs

String, Immutable String, String Comparison, String Concatenation, Substring, Methods of String class, String Buffer class, String Builder class, to String method, String Tokenizer class.

Exception Handling:

10 Hrs

Introduction, try and catch block, Multiple catch blocks, Nested try, finally block, throw keyword, Exception Propagation, throws keyword, Exception Handling with Method Overriding, Custom Exception

Collection framework:

5 Hrs

Array List class, Linked List class, List Iterator interface, HashSet class, Linked HashSet class, Tree Set class, Priority Queue class, ArrayDeque class, Map interface, HashMap class.

Database concepts:

10 Hrs

SQL (DDL, DML), PL-SQL, JDBC Drivers, steps to connect to the database, Connectivity with DB, Driver Manager, Connection interface, Statement interface, Result Set interface, PreparedStatement, ResultSetMetaData.

HTML:

5 Hrs

Tags, Attributes and Elements, Links, Images, Tables, Forms.

CSS:

5 Hrs

CSS basics, styles, CSS syntax



B.E. (Mechanical Engineering) Curriculum structure & Syllabus 2019 – 23 Batch

JSP: 5 Hrs

JSP - Overview, JSP - Lifecycle, JSP - Syntax, JSP - Directives, JSP - Actions,
JSP - Client Request, JSP - Server Response.

JavaScript/JQuery: 5 Hrs

JavaScript Output, JavaScript Statements, JavaScript Syntax,
JavaScript Variables, JavaScript Operators, JavaScript Arithmetic,
JavaScript Strings, JavaScript Events, JavaScript Loop, JavaScript Objects,
JavaScript functions.

Design patterns: 6 Hrs

Singleton pattern, Factory pattern

Reference Books:

1. Guide to the Project Management Body of Knowledge (PMBOK Guide),
Sixth Edition and Agile Practice Guide Bundle **by:** Project Management
Institute

Reference Manuals:

1. Studio Modeling Platform: Business Modeler Guide 3DEXPERIENCE
R2018x
2. Studio Modeling Platform: Embedding MQL Guide 3DEXPERIENCE
R2018x
3. Studio Modeling Platform: Matrix Navigator Guide 3DEXPERIENCE
R2018x
4. Dassault Systemes Studio Customization Toolkit 3DEXPERIENCE
R2018x
5. Dassault Systemes Documentation 3DEXPERIENCE R2018x



B.E. (Mechanical Engineering) Curriculum structure & Syllabus 2019 – 23 Batch

Curriculum Content

Course Code: 19EMEE305

Course Title: PLM -Technical

L-T-P: 0-0-3

Credits: 3

Contact Hrs: 6 hrs/week

ISA Marks: 80

ESA Marks: 20

Total Marks: 100

Teaching Hrs: 74

Exam Duration: 2 hrs

1. Fundamentals:

10 Hrs

Introduction to ENOVIA Components: Matrix Navigator, Business Modeler, System Manager, MQL Business Objects Attribute, Type, Relationship, Policy User Management: Person, Group, Role, Association Document Management: Files and File Format, File Check-in and Check-out Icon Mail Automating Processes: Triggers & JPOs Vaults & Stores Introduction to 3DEXPERIENCE ENOVIA Modules ENOVIA Architecture ENOVIA Licensing

2. Installation:

8 Hrs

Difference between CAS & No-CAS Setup Installation Procedure for No-CAS Mode: Installation of Database (SQL Server), Creation of Tables & User in Database, Installation of Studio Modelling Platform, Installation of 3DSpace, Installation of ENOVIA Modules, No-CAS Deployment of ENOVIA, Post Installation Configurations, Working with ENOVIA Services

3. Business Modeler:

10 Hrs

Attribute: Attribute Types & Ranges Dimension Type Policy: Policy States, Access, Signature User Management: Person, Role, Group, Association Relationship Interface

4. Matrix Navigator:

9 Hrs

Search Business Objects Create Business Objects Modify & Delete Business Objects Connect Business Objects Expand Business Objects View Business Object Basics & Attributes Promote & Demote Business Object Business Object File Check-in and Check-out Business Object Signature Approvals

5. MQL:

10 Hrs

Queries for Admin Objects: List, Create, Modify Queries for Business Objects: temp query, print, expand, add, delete, connect, disconnect, promote, demote, eval expression Help Commands

Schema/Data Model: Understanding ENOVIA OOTB Schema Model: PnO, Project Management, Common Document Model Schema Design Symbolic Names & Registration Understanding ENOVIA Access Precedence Auto-Naming Configuration

6. UI Configuration:

8 Hrs

Command Menu Categories/Tree Menu Portals & Channels Inquiry Tables: Flat Tables & Structure Browser Tables Editable Tables Settings for Table Columns Web Forms Settings for Web Form Fields Configuration of Create, Edit & View Business Object Details using Web Form

7. ADK:

Understanding ENOVIA Business Object & Domain Object classes ENOVIA



B.E. (Mechanical Engineering) Curriculum structure & Syllabus 2019 – 23 Batch	
String List & Map List classes ENOVIA APIs for Business Object Creation, Modification, Deletion ENOVIA APIs for business object querying, for getting business object details, for getting the connected business objects & their details	5 Hrs
8. JPOs:	4 Hrs
Creating JPOs Exporting & Importing JPOs JPO Macros JPO Method Invocation from JSP, from JPO and from UI Component settings JPO Compilation & Debugging	
9. Triggers:	4 Hrs
Trigger Configuration in Policy Creation of OOTB Trigger objects Understanding OOTB Events Understanding check, override and action triggers Disabling Triggers	
10. Data Model Customization:	6 Hrs
Understanding Unified Typing Principles Specialize Data Model: Packages, Types & Customer Extensions Administrate Data Model Importing & Exporting Packages.	

Reference Books:

1. Guide to the Project Management Body of Knowledge (PMBOK Guide), Sixth Edition and Agile Practice Guide Bundle **by:** Project Management Institute

Reference Mannuals:

1. Studio Modeling Platform: Business Modeler Guide 3DEXPERIENCE R2018x
2. Studio Modeling Platform: Embedding MQL Guide 3DEXPERIENCE R2018x
3. Studio Modeling Platform: Matrix Navigator Guide 3DEXPERIENCE R2018x
4. Dassault Systems Studio Customization Toolkit 3DEXPERIENCE R2018x
5. Dassault Systems Documentation 3DEXPERIENCE R2018x



B.E. (Mechanical Engineering) Curriculum structure & Syllabus 2019 – 23 Batch

Curriculum Content

Course Code: 19EMEE301

Course Title: Vehicle Structure and Design Optimization

L-T-P: 0-0-3

Credits: 3

Contact Hrs: 3 hrs/week

ISA Marks: 80

ESA Marks: 20

Total Marks: 100

Teaching Hrs: 80

Exam Duration: 2 hrs

**PART A
 (Study of Vehicle Structure)**

Sl. No.	Content	Teaching Hours
1	Brief explanation of different types of Loads and its effect; Different types of stresses- Static and Thermal, Different types of beams, Struts and Columns, thick and thin cylinders;	02
2	Understanding vehicle structure based on application; (e.g: 3box, load body and chassis)	04
3	Choices for Preparation of Virtual Model (1D, 2D, 3D representation);	03
4	Importance of Joinery;	02
5	Common performance measures for vehicle structures; (Stiffness, Modal, Durability)	03
6	Understanding Data and Assumptions; (e.g. nominal and tolerance, etc.)	02
7	Baseline data; (Initial collection of data which serves as a basis for comparison with the subsequently acquired data.)	02
8	Quality control in virtual environment;	03
9	Example case of static stiffness of BIW, Chassis; (BIW (short for Body in White) is a stage in automotive design and manufacturing. BIW refers to the body shell design of an automotive product such as cars. It is just a sheet metal welded structure. BIW will not have doors, engines, chassis or any other moving parts.)	05
10	Understanding effect of thermal loads on structure;	02
11	Understanding how to compute life based on stress results;	02
Total-Theory		30
Hands on Session		
01	Demonstrate importance of geometric parameters on performance of structure	05
02	Demonstrate importance of cross members on performance of structure	05
Total-Hands-on		10
TOTAL		40

**PART B
 (Design Optimization)**

Sl. No.	Content	Teaching Hours
1	Optimization in the Design Process, Engineering Design Practice, Characteristics of Different Industries, CAE and the Design Cycle, The impact of optimization on CAE, What is an Optimum Design?, Optimization terminology in a nutshell, Finding an Optimum, Formulation of an Optimization problem;	02
2	What is optimization in the context of EV structure;	02
3	Different types of design optimization;	02
4	How to plan and approach giving design guidance;	02



B.E. (Mechanical Engineering) Curriculum structure & Syllabus 2019 – 23 Batch

5	What is concept level design guidance (generative designs);	03
6	How to handle design guidance at a detailed design stage;	03
7	Examples - design guidance for stiffness attribute;	04
8	Examples - design guidance for durability attribute;	04
9	What is MDO, its application; (Medium density overlay-MDO is produced with a high-quality thermosetting resin-impregnated fiber surface bonded to one or both sides under heat and pressure to create an exterior-grade plywood panel.)	02
10	Watch-outs during design guidance process;	02
11	Examples - design guidance for NV & crash attribute;	04
Total-Theory		30
Hands on Session		
01	Optimize front control arm of a vehicle for all its performance criteria. FAW up by 10%	05
02	Optimize B-Pillar for roof crush if GVW goes up by 20% due to electrification Effect of wheel base increase on chassis stiffness and how to bring it back, Section optimization using morphing.	05
Total-Hands-on		10
TOTAL		40

Text Books/Reference Books:

1. Dr. N.K. Giri, Automotive Mechanics, 8th Edition, 2008, Khanna Publication, New Delhi.
2. Practical Aspects of Structural Optimization, Altair University, 3rd Edition.
3. Robin Hardy, Iqbal Husain, "Electric and Hybrid Vehicles". CRC Press, ISBN 0-8493-1466-6.
4. Ron Hodkinson and John Fenton, "Lightweight Electric/ Hybrid Vehicle Design". SAE International
5. John M. Miller, Propulsion Systems for Hybrid Vehicles" Institute of Electrical Engineers, London, ISBN0 863413366.
6. Automobile Electrical and Electronic systems, Tom Denton, Third Edition, 2004, SAE International, SAE ISBN 0 7680 147 2, Society of Automotive Engineers. Inc 400 common wealth Drive, Warrendale, PA 15096-0001 USA.

PROJECTS:

Part A

Objective: To carry out Baseline Performance, Virtual Testing and Design Countermeasures

Sl. No.	Content
01	Battery case for EV;
02	Motor compartment / Passenger compartment - improve performance;

Part B

Objective: To Provide design guidance

Sl. No.	Content
01	Battery case for EV (Metal vs Composite);
02	Motor compartment / Passenger compartment - improve performance;



B.E. (Mechanical Engineering) Curriculum structure & Syllabus 2019 – 23 Batch

Curriculum Content

Course Code:19EMEE302	Course Title: Advanced Statistics and Machine Learning	
L-T-P: 0-0-3	Credits: 3	Contact Hrs: 6 hrs/week
ISA Marks: 80	ESA Marks: 20	Total Marks: 100
Teaching Hrs: 80		Exam Duration: 2 hrs

Unit - I

1. Introduction to Machine Learning	25 Hrs
Introduction to Supervised, Unsupervised, and Reinforcement Learning; Statistics for ML; Exploratory Data Analysis; Use of Python and working with CSV/XLS files. Python hands on: Installation, Introduction to Python libraries (Pandas, Numpy, matplotlib and so forth)	

Unit - II

2. Applied Statistics	15 Hrs
Statistics for ML; Data Wrangling; Exploratory Data Analysis; Visualization; Use of Python and working with CSV/DB Hands on: Preprocessing techniques	
3. Machine Learning Methods	18 Hrs

Introduction to ML Life Cycle; Regression – Predictive Modeling; Regularization; Feature Selection; Metrics for Prediction; Visualization;

Unit - III

4. ML – Classification	22 Hrs
Introduction to Classification; Logistic Regression; Random Forests; Metrics for Classification; Visualization; Use of Python and DB	

Text Books

1. Trevor Hastie, Robert Tibshirani, and Jerome Friedman, “The Elements of Statistical Learning: Data Mining, Inference, and Prediction”, Springer, 2017.
2. Roger D Peng, “R Programming for Data Science”, Learn pub, 2015.

References

1. Geetha James, Trevor Hastie, Daniela Whitten, Robert Tibshirani, “An Introduction to Statistical Learning with Applications in R”, Springer, 2017.
2. Andrew Ng, “Machine Learning Yearning”, <https://www.mlyearning.org/>.
3. Michael Nielsen, “Neural Networks and Deep Learning”, <http://neuralnetworksanddeeplearning.com/>.



B.E. (Mechanical Engineering) Curriculum structure & Syllabus 2019 – 23 Batch

Curriculum Content

Course Code: 19EMEE307

Course Title: Machine Learning Applications

L-T-P: 0-0-3

Credits: 3

Contact Hrs: 6 hrs/week

ISA Marks: 80

ESA Marks: 20

Total Marks: 100

Teaching Hrs: 80

Exam Duration: 2hrs

Unit - 1

1. Unsupervised Learning

18 Hrs

Refresher week, Introduction to Unsupervised Learning, Clustering Analysis: K-Means, K-Medoid, DBSCAN, Hierarchical Clustering.

Unit - 2

2. Introduction to Deep Learning Frame-Work

15 Hrs

Introduction to DL, Exploring the popular DL frameworks, Getting started with TensorFlow, Introduction to Keras, Setting up the environment.

21 Hrs

3. Introduction to Deep Neural Network (DNN)

Introduction- What is Deep Learning, Why Deep Learning and Why now, Mathematical building blocks of NN, Examples on Regression, Classification.

Unit - 3

4. Deep Learning in practice

12 Hrs

Introduction to Convnets, Understanding Recurrent NN, Examples

Text Books

1. Deep Learning, Ian Goodfellow, Yoshua Bengio et.al
2. Trevor Hastie, Robert Tibshirani, and Jerome Friedman, “The Elements of Statistical Learning: Data Mining, Inference, and Prediction”, Springer, 2017
3. Deep Learning with Python, Francois Chollet

References

1. Andrew Ng, “Machine Learning Yearning”, <https://www.mlyearning.org/>.
2. Michael Nielsen, “Neural Networks and Deep Learning”, <http://neuralnetworksanddeeplearning.com/>.



B.E. (Mechanical Engineering) 7th and 8th Semester Curriculum Structure & Syllabus 2018 – 22 Batch



B.E. (Mechanical Engineering) Curriculum structure & Syllabus 2018 – 22 Batch

Semester: VII

No	Code	Course	Category	L-T-P	Credits	Contact Hours	ISA	ESA	Total	Exam Duration
1	15EMEC401	Operations Research	PSC	3-1-0	4	5	50	50	100	3 hours
2	15EMEC402	Design of Thermal Systems	PSC	3-0-0	3	3	50	50	100	3 hours
3	19EMEC401	IC Engines	PSC	2-0-0	2	2	50	50	100	3 hours
4	19EMEP401	Thermal Engineering Lab	PSC	0-0-1	1	2	80	20	100	2 hours
5	15EMEE4XX	Program Elective – 4	PE	3-0-0	3	3	50	50	100	3 hours
6	15EMEE4XX	Program Elective – 5	PE	3-0-0	3	3	50	50	100	3 hours
7	20EMEW401	Senior Design Project	PW	0-0-6	6	6	50	50	100	3 hours
8	15EHSA401	CIPE/EVS	CNC	Audit	0	2	50	50	100	3 hours
				14-1-7	22	26				

ISA: In Semester Assessment, **ESA:** End Semester Assessment, **L:** Lecture, **T:** Tutorials, **P:** Practical. **PSC:** Program Specific Core, **PRJ:** Project work, **PE:** Program Elective

Electives

Design Electives			E – Mobility Electives
Mechanics of Composite Materials	Design of Automotive Power Train	Design & Analysis of Experiments	Dynamics & Durability of Vehicles
15EMEE401	15EMEE402	15EMEE403	19EMEE401

Manufacturing Electives		
Operations Management	Supply Chain Management	Modern Trends in Manufacturing
15EMEE405	15EMEE406	15EMEE417

Thermal Electives	
Computational Heat Transfer and Fluid Flow	Fundamentals of Gas Turbines
15EMEE407	15EMEE408



B.E. (Mechanical Engineering) Curriculum structure & Syllabus 2018 – 22 Batch

Semester: VIII

No	Code	Course	Category	L-T-P	Credits	Contact Hours	ISA	ESA	Total	Exam Duration
1	15EMEE4XX	Program Elective - 6	PE	3-0-0	3	3	50	50	100	3 hours
2	15EMEO45X	Open Elective	OE	3-0-0	3	3	50	50	100	3 hours
3	18EMEI493	Internship Training (Optional In place of 1 & 2)	-	0-0-6	6	----	80	20	100	3 hours
4	20EMEW402 / 20EMEW494	Capstone Project / Internship Project	PW	0-0-11	11	11	50	50	100	3 hours
				6-0-17	17	17				

ISA: In Semester Assessment, **ESA:** End Semester Assessment, **L:** Lecture, **T:** Tutorials, **P:** Practical. **PSC:** Program Specific Core, **PRJ:** Project work, **PE:** Program Elective

Electives

Design Electives	Manufacturing Electives	Thermal Electives	
Aircraft Systems and Design ---- 15EMEE413	Industrial Engineering: Methods & Practices---- 15EMEE414	Advanced Energy technology---- 15EMEE415	Thermal Management of Electronic Equipment---- 15EMEE416

Open Electives

Introduction to Nano-Science & Nano Technology ----- 15EMEO401	Nano Technology ----- 15EMEO402	Design of Experiments ----- 15EMEO403	Engine Management Systems ----- 15EMEO404
--	---------------------------------	---------------------------------------	---



VII Sem Bachelor of Engineering (Mechanical Engineering)

Curriculum Content

Course Code: 15EMEC401

Course Title: Operations Research

L-T-P: 3-1-0

Credits: 4

Contact Hrs: 5 hrs/week

ISA Marks: 50

ESA Marks: 50

Total Marks: 100

Teaching Hrs: 40

Exam Duration: 3 hrs

Unit I

1. Introduction to Operations Research

3 Hrs

System orientation, Use of interdisciplinary teams in OR, Necessity of OR in business and industry, Scope of OR in modern management, OR and Decision making

2. Linear Programming

12 Hrs

Formulation, Identification of decision variables, Constructing Objective Functions and Constraints, Assumptions, Practical Examples, Methods of Solution, Graphical Method, Simplex method (Big M and 2-phase methods), By computer, Examples

Unit II

3. Duality Theory and Sensitivity Analysis

7 Hrs

Duality theory, Existence of Dual of a LP problem, Economic interpretation of duality Primal Dual relationships in formulation and their solutions, Sensitivity Analysis or Post Optimality Analysis, Dual Simplex Method, Changes affecting feasibility, Changes affecting optimality, Examples

4. Transportation Models

8 Hrs

The transportation algorithm, Formulation as a LP problem, Determination of initial solution, Stepwise improvement to obtain optimal solution, Special cases such as multiple, unbalanced, degeneracy etc. The assignment model, Formulation as a LP problem, The Hungarian method of solution, Examples

Unit III

5. Network Models

5 Hrs

The maximal flow problems, The shortest route problem, The minimal spanning tree problem, Critical Path Method(CPM) and Program Evaluation & Review Technique, Network representation of simple projects, Critical path Crashing of project duration, Examples

6. Game Theory

5 Hrs

Formulation of games, Two person zero sum game, Dominance property, Games with and without saddle point, Graphical solutions (2 x n, m x 2 game)

Text Books:

1. F.S. Hillier and G.J. Lieberman, Introduction to Operations Research, 9th Edition, McGraw Hill, India, 2017.
2. H.A. Taha, Operations Research: An Introduction, 10th Edition, Pearsonl, 2017.

Reference Books:

1. Vohra N. D, Quantitative Techniques in Management, 5th Edition, Mcgraw Higher Ed.,2017
2. R. Panneerselvam, Operations Research, 2nd Edition, Phi Learning Pvt. Ltd, 2009.



B.E. (Mechanical Engineering) Curriculum structure & Syllabus 2018 – 22 Batch

Curriculum Content

Course Code: 15EMEC402	Course Title: Design of Thermal Systems	
L-T-P: 3-0-0	Credits: 3	Contact Hrs: 3 hrs/week
ISA Marks: 50	ESA Marks: 50	Total Marks: 100
Teaching Hrs: 40		Exam Duration: 3 hrs

Unit I

1. Heat exchangers Classification and Selection: 5 Hrs

Introduction, Recuperation and Regeneration, Transfer process, Geometry and Construction, - Tubular Heat Exchanger, Plate Heat Exchanger, Extended Surface heat exchanger, Heat Transfer Mechanisms, Flow arrangements, Applications and Selection of Heat Exchangers.

2. Design of Shell and Tube heat exchanger 10 Hrs

Construction of shell and tube exchanger, specifications and classification of S&T Heat Exchanger, some Typical operating limits for heat exchangers of S&T Type, Design of Shell and Tube Heat Exchangers.

Unit II

3. Condensers : Classification of condensers, various types of condensers and their applications, Shell and tube condensers : Analysis and design, special consideration in Reflux Condensers: Flooding , Condensers for mixtures , Design of shell and tube Exchangers, compact condensers, air cooled condensers , direct contact condensers , numerical problems 5 Hrs

4. Modeling of Thermal Equipment: 6 Hrs

Counter flow heat exchanger, Evaporators and Condensers, Heat exchanger effectiveness, Effectiveness of a counter flow heat exchanger, NTU, Pressure drop and pumping power, Numerical Problems.

5. Optimization: 4 Hrs

Mathematical representation of optimization problems, A water chilling system, Optimization procedure, Setting up the mathematical statement of the optimization problem.

Unit III

6. Lagrange Multipliers: 5 Hrs

The Lagrange multiplier equations, unconstrained optimization, Constrained optimization.

7. Dynamic Programming: 5 Hrs

Characteristic of the Dynamic programming solution, Apparently constrained problem, Application of Dynamic programming to energy system problems.

Text Books:

1. W.F.Stoecker, Design of Thermal Systems, 3 ed., MGH, 1989.
2. Sarit K. Das., Process heat transfer, Narosa Publishing House 1st Edition, 2005



B.E. (Mechanical Engineering) Curriculum structure & Syllabus 2018 – 22 Batch

3. Sadik Kakac, Hongtan Liu, Heat Exchanger Selection, Rating and Thermal Design, 2 ed., CRC Press, 2002.

Reference Books:

1. Yogesh Jaluria, Design and Optimisation of Thermal Systems, 2nd ed., CRC Press, 2008
2. Hodge B.K., Analysis and Design of Thermal Systems, 1 ed., PHI, 1990.



B.E. (Mechanical Engineering) Curriculum structure & Syllabus 2018 – 22 Batch

Curriculum Content

Course Code: 19EMEC401

Course Title: I C Engines

L-T-P: 2-0-0

Credits: 2

Contact Hrs: 2 hrs/week

ISA Marks: 50

ESA Marks: 50

Total Marks: 100

Teaching Hrs: 26

Exam Duration: 3 hrs

Unit I

1. Introduction to I C Engines

5 Hrs

Internal Combustion Engine Classification, Operating Cycles, Spark Ignition and Compression-Ignition Engines.

Combustion in Spark Ignition Engines

Ignition limits, Normal combustion, Thermodynamic Analysis of SI Engine Combustion - stages, ignition lag, and effect of engine variables on ignition lag Causes of Cycle-by-Cycle and Cylinder-to-Cylinder Variations and flame propagation phase, detonation, Abnormal Combustion: Knock Fundamentals and fuel factors, Factors affecting knock.SI engine combustion chambers.

2. Combustion in Compression Ignition Engines

5 Hrs

Types of Diesel Combustion Systems, Direct and Indirect-Injection Systems, Comparison, Combustion Efficiency, Normal combustion – stages, delay period, variables affecting delay period. Diesel knock, comparison between diesel and petrol engine knocks. CI engine combustion chambers, Fuel spray behavior. HRR analysis.

Unit II

3. Engine Exhaust Emission Control

5 Hrs

Formation of NOX, HC/CO mechanism, Smoke and Particulate emissions, Green House Effect, Methods of controlling emissions, Three way catalytic converter and Particulate Trap, Emission (HC, CO, NO and NOX) measuring equipments, Smoke and Particulate measurement, Indian Driving Cycles and emission norms.

4. Overall Engine Performance

6 Hrs

Alternate fuels, Operating Variables that Affect SI Engine Performance, Efficiency, and Emissions: Spark Timing, Mixture Composition, Load and Speed, Compression Ratio. Variables that Affect CI Engine Performance, Efficiency, and Emissions: Load and Speed, Fuel-Injection Parameters.

Unit III

5. Recent Trends in IC Engines

5 Hrs

Dual fuel Engine, Common Rail Direct Injection Diesel Engine (CRDI), Homogeneous Charge Compression Ignition Engine (HCCI), Reactivity controlled compression ignition engine (RCCI) Lean Burn Engine, Surface Ignition alcohol CI Engine, VVT engines, Gasoline Direct Injection Engine.

Text Books:

1. John B Heywood, "Internal Combustion Engine Fundamentals", Tata McGraw-Hill, 1988
2. Heinz Heisler, "Advanced Engine Technology", SAE International Publications, USA, 1998
3. Patterson D.J. and Henein N.A, "Emissions from combustion engines and their control", Ann ArborScience, publishers Inc, USA, 1978



B.E. (Mechanical Engineering) Curriculum structure & Syllabus 2018 – 22 Batch

Reference Books:

1. Ganesan V. “Internal Combustion Engines”, Third Edition, Tata Mcgraw-Hill, 2007.
2. Gupta H.N, “Fundamentals of Internal Combustion Engines”, Prentice Hall of India, 2006.
3. Ulrich Adler, “Automotive Electric / Electronic Systems”, Published by Robert Bosh GmbH, 1995.

B.E. (Mechanical Engineering) Curriculum structure & Syllabus 2018 – 22 Batch

Curriculum Content

Course Code: 19EMEP401

Course Title: Thermal Engineering Lab

L-T-P: 0-0-1

Credits: 1

Contact Hrs: 2 hrs/week

ISA Marks: 80

ESA Marks: 20

Total Marks: 100

Teaching Hrs: 24

Exam Duration: 2 hrs

1. Fluid mechanics and hydraulic machines

- i. To obtain the performance characteristics of centrifugal blower
- ii. To study the effect of speed on the performance of centrifugal pump
- iii. To study the effect of speed / gate opening on the performance of Pelton turbine
- iv. To study the effect of speed / gate opening on the performance of Francis turbine

2. Heat transfer

- i. To determine the emissivity of given surface
- ii. To determine the thermal conductivity of metal bar and to study the effect of temperature on thermal conductivity
- iii. To study the performance of pinfin
- iv. To study the performance of vapour compression refrigeration (VCR) system

3. I C Engines

- i. To study the performance of two stroke engine
- ii. To obtain the performance characteristics of multicylinder engine using Morse test
- iii. To study the effect of engine operating variables (Injection pressure/ injection timing/ compression ratio)

Materials and Resources Required:

1. White, F.M., Fluid Mechanics, 5ed., McGraw Hill International, 2003
2. Nicati Ozisik - Heat transfer-A basic approach, Tata Mc Graw Hill, 2002
3. Yunus A. Cengel - Heat transfer, a practical approach, Tata Mc Graw Hill, 4th Edn, 2011
4. John B. Heywood, Fundamentals of Internal Combustion Engines, McGrawHill, Singapore.
5. Ganesan.V, Internal Combustion Engines, Tata McGraw Hill, 2nd Edition, 2003
6. Manuals: Lab manual prepared by the Department

B.E. (Mechanical Engineering) Curriculum structure & Syllabus 2018 – 22 Batch

Curriculum Content

Course Code: 15EMEE401	Course Title: Mechanics of Composite Materials	
L-T-P: 3-0-0	Credits: 3	Contact Hrs: 3 hrs/week
ISA Marks: 50	ESA Marks: 50	Total Marks: 100
Teaching Hrs: 40		Exam Duration: 3 hrs

Unit - I

1: Introduction to Composite Materials 5 Hrs

Introduction, Matrix materials-polymers, metals and ceramics; Reinforcements, Interfaces-wettability, interactions at the interface, types of bonding at the interface, optimum interfacial bond strength.

2: Polymer Matrix Composites 5 Hrs

Types, characteristics ,processing of PMCs, Layup and curing, fabricating process, open and closed mould process, hand layup techniques; structural laminate bag molding, production procedures for bag molding; filament winding, pultrusion, pulforming, thermo-forming, injection molding, blow molding.

3: Metal and Ceramic Matrix Composites 5 Hrs

Types of MMCs, base metals selection; important metallic matrices; processing-liquid state and solid state processes; interfaces in MMCs; Need for production of MMC's and its applications; Types of CMCs, processing of CMCs-cold pressing and sintering, hot pressing, reaction bonding processes, liquid infiltration, directed oxidation, in-situ chemical reaction techniques, sol-gel and polymer pyrolysis, applications of CMCs.

Unit – II

4: Macro Mechanics of a Lamina 8 Hrs

Hooke's law for different types of materials, Number of elastic constants, Derivation of nine independent constants for orthotropic material, Two - dimensional relationship of compliance and stiffness matrix. Hooke's law for two-dimensional angle lamina, engineering constants - Invariant properties. Numerical problems.

5: Micro Mechanics of a Lamina: 7 Hrs

Introduction, volume and weight fractions, Assumption and limitations of micromechanical analysis, Elastic properties of a lamina, longitudinal strength and stiffness, Transverse young's modulus, major Poisson's ratio and in-plane shear modulus. Problems on micromechanical analysis. Numerical problems.

Unit – III

6: Macro Mechanics of Laminate 5 Hrs

Macro Mechanics of Laminate: Introduction, Laminate code, Stress–Strain Relations for a Laminate, Classical Lamination theory, assumptions of CLT, Stress- Strain equation and variation in a laminate, force and moment resultants related to midplane strains and curvatures , Numerical problems.



B.E. (Mechanical Engineering) Curriculum structure & Syllabus 2018 – 22 Batch

7: Applications:

5 Hrs

Aircrafts, missiles, Space hardware, automobile, Electrical and Electronics, Marine, Recreational and sports equipment, future potential of composites.

Text Books:

1. Krishan K. Chawla, Composite Materials - Science and Engineering, 3rd Edition, Springer, 2012.
2. Robert M. Jones, Mechanics of Composite Materials, 2nd Edition, Taylor & Francis Inc. 1999.

Reference Books:

1. D. Hull and T. W. Clyne, An Introduction to Composite Materials (Cambridge Solid State Science Series), 2nd Edition, Cambridge University Press, 1996.
2. Autar K. Kaw, Mechanics of Composite Materials, 2nd Edition, CRC Press, Taylor and Francis Group, 2006.



B.E. (Mechanical Engineering) Curriculum structure & Syllabus 2018 – 22 Batch

Curriculum Content

Course Code: 15EMEE402

Course Title: Design of Automotive Power Train

L-T-P: 3-0-0

Credits: 3

Contact Hrs: 3 hrs/week

ISA Marks: 50

ESA Marks: 50

Total Marks: 100

Teaching Hrs: 40

Exam Duration: 3 hrs

Unit I

1: Vehicle Performance Parameters

5 Hrs

Vehicle drag, power for propulsion, resistances to vehicle motion, traction and tractive effort, relation between engine revolutions and vehicle speed, road performance curves (acceleration, grade ability and drawbar pull), numericals.

2. General Considerations in Engine Design

5 Hrs

General Design Consideration, Selection of type: Process, Cycle, Number of Cylinders, Arrangement of Cylinders, Single and Double acting, Engine Speed, Piston Speed, Stroke to Bore Ratio.

3. Cylinder, Cylinder Head and Piston

6 Hrs

Function, construction, materials and design of cylinder, cylinder head and piston, piston pin and piston rings.

Unit II

4. Connecting Rod and Crankshaft

5 Hrs

Function, construction, materials and design of connecting rod, design of crankshaft and its types.

5. Flywheel

5 Hrs

Function, construction, material, types. Stresses in flywheel rim and arms. Design of flywheel.

6. Power Transmission- Manual Gearbox

5 Hrs

Necessity of gear box, Sliding mesh gear box, Constant mesh gear box, Synchromesh gearbox, gear synchronization and engagement.

Unit III

7. Power Transmission- Automatic Gearbox

5 Hrs

Architecture, fundamental design and operation principles of Torque convertors, Epicyclic geartrains and Dual Clutch Transmission.

8. Power Transmission- Drive Shaft, Final Drive and Differential

5 Hrs

Construction & types of propeller/drive shafts, Final drive, Differential-principle, open and non-slip differentials, differential lock. Electronic limited slip differential. Four wheel drive arrangements.

Text Books:

1. Dr. N.K. Giri, Automotive Mechanics, 8th Edition, Khanna Publication, New Delhi, 2008.
2. Sharma and Aggarwal, Machine Design, 12th Edition, S.K. Kataria & Sons, New Delhi, 2012.

Reference Books:

1. Heinz Heisler, Advanced Vehicle Technology, 2nd Edition, Butterworth Heinemann, 2002.
2. Heywood, John B. Internal Combustion Engine Fundamentals, McGraw-Hill, New York 1988.



B.E. (Mechanical Engineering) Curriculum structure & Syllabus 2018 – 22 Batch

Curriculum Content

Course Code: 15EMEE403

Course Title: Design and Analysis of Experiments

L-T-P: 3-0-0

Credits: 3

Contact Hrs: 3 hrs/week

ISA Marks: 50

ESA Marks: 50

Total Marks: 100

Teaching Hrs: 40

Exam Duration: 3hrs

Unit I

1. Introduction

Need for Research, Need for Design of Experiments, Experimental Design Techniques, Applications of Experimental Design. 4 Hrs

2. Taguchi's Approach to Quality

Taguchi's Approach to Quality and Quality loss function, Noise Factors and Average Quality Loss, Exploiting Non Linearity, Classification of Parameters, Exercises. 4 Hrs

3. Analysis of Variance

Test of Hypothesis using t-test, Z –test, Chi square and F-tests, No-Way and One-Way ANOVA, Exercises. 8 Hrs

Unit II

4. Full Factorial Design of Experiments

Two-Factor Complete Factorial Experiments, Complete Factorial experiment with Three Factors and 2ⁿ Factorial Experiments, Exercises. 8 Hrs

5. Fractional Factorial Design of Experiments

Half Fraction of 2² Factorial Experiments, Half Fraction of 2³ Factorial Experiments, Half Fraction of 2⁴ Factorial experiments, Exercises. 4 Hrs

6. Robust Design

Control Factors and their Levels, Matrix Experiment and Data Analysis Plan, Conducting the Experiment using Orthogonal Array and Data analysis, Exercises. 4 Hrs

Unit – III

7. Response Surface Methodology

Central Composite Design and Box-Behnken Design, Case Studies 4 Hrs

8. Signal to Noise Ratio

Relationship between Signal to Noise Ratio and quality loss after adjustment, Signal to Noise Ratios for static problems, Signal to Noise Ratios for dynamic problems, Exercises. 4 Hrs

Text Books:

1. Douglas C. Montgomery, "Design and Analysis of Experiments", John Wiley and Sons.
2. Madhav S. Phadke, "Quality Engineering using Robust Design", Prentice Hall PTR, Englewood Cliffs, New Jersey.



B.E. (Mechanical Engineering) Curriculum structure & Syllabus 2018 – 22 Batch

3. R. Panneerselvam, “Design and Analysis of Experiments- R PHI Learning Private Limited ,New Delhi.

Reference Books:

1. R. H. Myers and D. C. Montgomery and Anderson-Cook C. M. “Response Surface Methodology: Process and Product Optimization Using Designed Experiments”, John Wiley & sons, Inc., New York.
2. Philips .J. Ross, “Taguchi Techniques for Quality Engineering”, McGraw Hill, New York.



B.E. (Mechanical Engineering) Curriculum structure & Syllabus 2018 – 22 Batch

Curriculum Content

Course Code: 15EMEE405

Course Title: Operations Management

L-T-P: 3-0-0

Credits: 3

Contact Hrs: 3 hrs/week

ISA Marks: 50

ESA Marks: 50

Total Marks: 100

Teaching Hrs: 40

Exam Duration: 3 hrs

Unit I

1. Operations management & operations decision making

8 Hrs

Introduction, importance of operations management in manufacturing and service industries, Information and Non-manufacturing systems. Factors affecting productivity. The environment of operations. Characteristics of decisions, framework for decision-making, decision methodology, decision support systems, economic models and statistical models. Numericals

2. Forecasting demand

6 Hrs

Forecasting objectives and uses, forecasting variables, opinion and judgmental methods, time series methods, exponential smoothing, regression and correlation methods, application and control of forecasts. Numericals

3. Aggregate planning and master scheduling

4 Hrs

Introduction- Planning and scheduling, objectives of aggregate planning and Aggregate planning methods, master scheduling objectives, master scheduling methods, Numericals

Unit II

4. Material and Capacity Requirements Planning

4 Hrs

Overview: MRP and CRP, MRP: Underlying concepts, System parameters, MRP logic, System refinements, Capacity management, and CRP activities. MRP, MRP-II and ERP, Numericals

5. Scheduling, single machine scheduling & flow –shop & Job shop scheduling

12 Hrs

Production activities, PAC objectives and data requirements, concept, measures of performance, SPT rule, Weighted MFT, EDD rule, minimizing the number of tardy jobs. Numerical problems, Johnson's rule for 'n' jobs on 2 and 3 machines. Numericals

Job-shop scheduling: Types of schedules, heuristic procedure, scheduling 2 jobs on 'm' machines. Numericals

Unit III

6. Lean manufacturing

5 Hrs

Introduction, Japanese concept of continuous improvement (Kaizen), innovation concept of improvement, need for continuous improvement, steps in implementing continuous improvement, 5S principles, Lean manufacturing history

7. Just in time- an introduction

5 Hrs

Spread of JIT movement, the new production system research association of Japan, core Japanese practices of JIT, creating continuous manufacture, Enabling JIT to occur, basic element of JIT, benefits of JIT



B.E. (Mechanical Engineering) Curriculum structure & Syllabus 2018 – 22 Batch

Text Books:

1. William J Stevenson “Operations Management” Mc Graw Hill, 2018, 12th Edition
2. Krajewski E. J. and Ritzman, ‘Operations Management’, Strategy and Analysis, Pearson Education, 2018.

Reference Books:

1. Monks, J.G., Operations Management, McGraw-Hill International Edition, 1987.
2. Pannerselvam. R., Production and Operations Management, Prentice Hall India, 2003
3. Chary, S.N., ‘Production and Operations Management’, Tata-McGraw Hill, 2004
4. Nicholas J. Aquilano, ‘Fundamental of Operations Management’, Irwin/McGraw-Hill; 4th edition.

B.E. (Mechanical Engineering) Curriculum structure & Syllabus 2018 – 22 Batch

Curriculum Content

Course Code: 15EMEE406	Course Title: Supply Chain Management	
L-T-P: 3-0-0	Credits: 3	Contact Hrs: 3 hrs/week
ISA Marks: 50	ESA Marks: 50	Total Marks: 100
Teaching Hrs: 40		Exam Duration: 3 hrs

Unit – 1

1: Understanding Supply Chain - Meaning of SCM, Supply chain stages, Decision phases in supply chain (SC), Process view of SC, Examples of supply chain, Competitive and supply chain strategies, Achieving Strategic Fit and Expanding Strategic Scope. 5 Hrs

2: Supply Chain Drivers and Metrics - Drivers of SC performance, framework for structuring drivers, Facilities, Transportation, Information, Inventory, Obstacles to achieve Strategic Fit. 5 Hrs

3: Designing the Supply Chain Network - Role of distribution in SC, Factors influencing distribution network design, Design options for a distribution network, Role of network design in SC, Factors influencing network design decisions. 5 Hrs

Unit – 2

4: Sourcing in Supply Chain - Role of sourcing in SC, Supplier scoring and assessment, Supplier selection and assessment, Design collaboration. 4 Hrs

5: Transportation in Supply Chain - Role of transportation in SC & factors affecting transportation decisions, Modes of transportation and their performance characteristics, Design options for a transportation network, Trade-offs in transportation design, Tailored transportation. 6 Hrs

6: Co-ordination in Supply Chain - Lack of SC Co-ordination & the Bullwhip Effect, Effect of lack of co-ordination on performance, Obstacles to co-ordination in the SC, Managerial levers to achieve co-ordination, Building a strategic partnership & trust within a supply chain and spot customers. 5 Hrs

Unit – 3

7: Role of Technology in Supply Chain - Role of IT in supply chain, Supply chain IT framework, Customer Relationship Management, Internal SCM, SRM. 5 Hrs

8: Emerging Concepts in Supply Chain - Role of E-Business in SC, E-Business framework, Reverse Logistics; Reasons, Activities, Role, RFID Systems; Components, applications, implementation. 5 Hrs



B.E. (Mechanical Engineering) Curriculum structure & Syllabus 2018 – 22 Batch

Text Books:

1. Sunil Chopra and Peter Meindl 'Supply Chain Management – Strategy, Planning and Operation', 2nd ed 2003, Pearson Education Inc. ISBN: 81-297-0172-3.
2. Douglas Lambert and James Stock, 'Strategic Logistics Management', 4th Ed, Irwin McGraw Hill. ISBN: 0-07-118122-9.

Reference Books:

- 1 Michael Hugos, 'Essentials of Supply Chain Management', 2nd Ed 2003, John Wiley and Sons.
- 2 Robert B. Handfield and Ernest L. Nichols, 'Supply Chain Redesign-Transforming Supply Chain into Integrated Value Systems', ed 2002, Pearson Education Inc. ISBN: 81- 297-0113-8.
- 3 Jeremy F. Shapiro and Duxbury, 'Modeling the Supply Chain', Ed 2002, Thomson Learning. ISBN: 0-534-37363.
- 4 Kapoor, 'Marketing Logistics: A Supply Chain Approach', Pearson Education Pvt Ltd. ISBN-8129702444.

B.E. (Mechanical Engineering) Curriculum structure & Syllabus 2018 – 22 Batch

Curriculum Content

Course Code: 15EMEE417

Course Title: Modern Trends in Manufacturing

L-T-P: 3-0-0

Credits: 3

Contact Hrs: 3 hrs/week

ISA Marks: 50

ESA Marks: 50

Total Marks: 100

Teaching Hrs: 40

Exam Duration: 3 hrs

Unit - I

1. Systematic Approach for Manufacturing Strategy:

4 Hrs

Seven Losses Regarding Productivity and Profitability, Feasibility Study of Productivity Improvement, Four Levels of Manufacturing Strategy.

2. Management and Productivity in Engineering:

8 Hrs

Definition of Engineering, Management and Management Engineering, Industrial Engineering and Productivity, Necessity of Facts and Work Measurement.

Productivity, Purpose of Productivity Improvement, Engineering Approach for Productivity, Three Levels of Improvement, Points of Successful Productivity, Relationship of Methods, Performance, and Utilization to Standard Time.

3. Concurrent Engineering:

3 Hrs

Introduction, importance of CE, building blocks of CE, Important factors in concurrent engineering process, communication models, benefits and its tools.

Unit – II

4. Continuous Process Improvement:

8 Hrs

Introduction, Japanese concept of continuous improvement (kaizen), innovation concept of improvement, need for continuous improvement, tools for continuous improvement, steps in implementing continuous improvement, three pillars of continuous improvement, standardization, quality circles, suggestion systems, kaizen and management, kaizen umbrella, TPM, Six sigma, FMEA and discussion of few case studies.

5. Pull Production Systems:

7 Hrs

Introduction to TPS, KANBAN system, difference between pull and push system, other types of kanban, kanban rules, adapting to fluctuation in demand through kanban, a detailed kanban system example, supplier kanban and sequence schedule for kanban.

Unit - III

6. Quality Management Systems:

5 Hrs

Need for ISO 9000 and Other Quality Systems, ISO 9000:2000 Quality System – Elements, Implementation of Quality System, Documentation, Quality Auditing, QS 9000, ISO 14000 – Concept, Requirements and Benefits. Occupational Health & Safety Management (OSHAS -18001) standards, Environmental Management Certification (ISO 14001) and its benefits to stakeholders.



B.E. (Mechanical Engineering) Curriculum structure & Syllabus 2018 – 22 Batch

7. Six sigma:

5 Hrs

Principles of Six sigma, project selection for six sigma, six sigma problem solving, design for six sigma, six sigma in service and small organization, six sigma and lean production, statistical thinking and application, statistical foundation, statistical methodology, design of experiments, analysis of variances

Text Books:

1. Masaki Imai, 'KAIZEN', McGraw Hill International.
2. Shigeyasu Sakamoto , "Beyond World-Class Productivity", Springer-Verlag London Limited 2010.
3. Dale H. Besterfield, "Total Quality Management", Pearson Education, Asia.

Reference Books:

1. Richard J. Schonberger, 'Japanese Manufacturing Techniques', The Free Press – Macmillan Publication.
2. James R. Evans and William M. Lindsay, 'The Management and Control of Quality'.

B.E. (Mechanical Engineering) Curriculum structure & Syllabus 2018 – 22 Batch

Curriculum Content

Course Code: 15EMEE407	Course Title: Computational Heat transfer and Fluid Flow	
L-T-P: 3-0-0	Credits: 3	Contact Hrs: 3 hrs/week
ISA Marks: 50	ESA Marks: 50	Total Marks: 100
Teaching Hrs: 40		Exam Duration: 3 hrs

Unit - I

- | | |
|--|-------|
| 1. Computational Fluid Dynamics (CFD) Solution Procedure: | 7 Hrs |
| CFD applications in Research and Design, CFD Problem set-up-Creation of geometry, Mesh generation, Specification of boundary conditions. CFD Solver- Initialization and Convergence monitoring. Post Processor-Plots, data reports and Animation | |
| 2. Governing Equations for CFD: | 8 Hrs |
| Continuity Equation, Momentum Equation, Energy Equation- Physical Interpretation and comments. The additional equations for turbulent flow, Generic form of Governing equations, Physical Boundary conditions | |

Unit – II

- | | |
|---|-------|
| 3. CFD Techniques: | 7 Hrs |
| Discretization of Governing Equations- Finite difference method, Finite volume method, Converting governing equations into algebraic equations, Direct and Iterative solutions, Pressure- velocity coupling-SIMPLE scheme | |
| 4. CFD Solution Analysis: | 8 Hrs |
| Consistency, Stability, Convergence, Accuracy and Efficiency of CFD solutions. Accelerating convergence, controlling solution errors, verification and Validation. Case studies related to fluid flow through channel and pipe bend | |

Unit - III

- | | |
|--|-------|
| 5. Practical Guidelines for CFD Simulation and Analysis: | 5 Hrs |
| Grid generation- Guidelines on grid quality and grid design, Local refinement and solution adaption. Guidelines on Boundary conditions – Setting inlet, outlet and wall boundary conditions. Symmetric and Periodic Boundary conditions. Turbulence Modelling- Approaches, selection strategies, Case study: modeling of hydrofoil flows | |
| 6. Advanced Topics in CFD: | 5 Hrs |
| Advances in Numerical methods and Techniques- Moving grids, Multigrids, Parallel Computing and Immersed boundary methods. Advances in computational models- Direct numerical Simulation(DNS), Large Eddy Simulation(LES), RANS-LES, Lattice Boltzmann method, Monte-Carlo method, Particle methods | |



B.E. (Mechanical Engineering) Curriculum structure & Syllabus 2018 – 22 Batch

Text Books:

1. Jiyuan Tu, Guan Heng Yeoh, Chaoqun, Computational Fluid Dynamics, Butterworth-Heinemann, 1st Edition 2008
2. Dale A. Anderson, John C. Tannehill and Richard H. Platcher.. Computational Fluid Mechanics and Heat Transfer; McGraw Hill Book Company, 2001

Reference Books:

1. Suhas V. Patankar, Numerical Fluid flow and Heat transfer, Hemisphere Series on Computational Methods in Mechanics and Thermal Science, 2nd Edn. 2000
2. Joel H. Ferziger and Milovan Peric, Computational Methods for Fluid Dynamics, 3rd Edition, Springer-Verlag, Berlin, 2001
3. Anderson J D, Computational Fluid Dynamics- The Basics with Applications, MGH, 2nd Ed. 2001



B.E. (Mechanical Engineering) Curriculum structure & Syllabus 2018 – 22 Batch

Curriculum Content

Course Code: 15EMEE408

Course Title: Fundamentals of Gas Turbines

L-T-P: 3-0-0

Credits: 3

Contact Hrs: 3 hrs/week

ISA Marks: 50

ESA Marks: 50

Total Marks: 100

Teaching Hrs: 40

Exam Duration: 3 hrs

Unit - I

1 Principles of Gas Turbine and Applications

4 Hrs

Introduction to turbo machines, history of gas turbines, gas turbine cycles and applications – (Land, Water/Marine and Air/Aero) Components of Gas Turbines (Compressors, Combustors, Turbines, Exhaust systems). Working of Gas Turbines.

2 Compressor

7 Hrs

Types of compressors, (Centrifugal and Axial), relative merits and demerits, Criteria for selecting type of compressors.

Centrifugal Compressors: Principle of operation, work done and pressure rise diffuser, compressibility effects, compressor characteristics and design procedures.

Axial Flow Compressor: Basic operations, elementary theory, factors affecting stage pressure ratio, Blockage in the compressor annulus, effect of compressibility, pre-whirl, supersonic flow, degree of reaction, design process, blade design, calculation of stage performance, off-design performance.

3 Fuel System

4 Hrs

Fuel specifications, Properties, Manual and automatic control, Fuel control systems, Fuel spray nozzles, Fuel heating, Effect of a change of fuel, Gas turbine fuels, Fuel requirements, Vapor locking and boiling, Fuel contamination control.

Unit – II

4 Combustion System

5 Hrs

Introduction, Combustion process, Enthalpy of formation, Fuel supply, Types of combustion chamber, Can-annular combustion chamber, Tube-annular combustion chamber, Annular combustion chamber, Combustion chamber performance, Combustion intensity, Combustion efficiency, Combustion stability Emissions, Materials.

5 Axial Flow Turbines

5 Hrs

Types of Turbines, spool shafts in aero engines, Advantages and disadvantages, Turbine geometry, Thermodynamic and Aerodynamic theory, velocity diagrams, Impulse turbine, turbine blade cooling. **Exhaust System:** Introduction, Exhaust gas flow, environmental considerations, construction and materials.

6 Prediction of Performance of Simple Gas Turbines

5 Hrs

Component characteristics, off design operation of the single shaft gas turbine, off-design operation of free turbine engine.



B.E. (Mechanical Engineering) Curriculum structure & Syllabus 2018 – 22 Batch

Unit - III

7 Cooling, Seals and Lubrication System

5 Hrs

The cooled turbine, methods of blade cooling, **Seals:** Non contacting seals - labyrinth seals, ring seals, Mechanical seals, Seal system, and dry gas seals, attrition coatings. **Lubrication Systems:** Basic oil system, lubrication management program, selection, oil contamination, filter selection, cleaning and flushing, oil sampling and testing

8 Materials of Gas turbine and Maintenance

5 Hrs

Introduction, Super alloys-Nickel based iron-nickel, Cobalt, Thermal barrier coating for jet engine alloys, advanced materials for jet engines. **Maintenance:** Introduction, On-wing maintenance, Scheduled maintenance, Unscheduled maintenance, Condition monitoring, Flight deck indicators, In-flight recorders, Ground indicators, Maintenance precautions, Trouble shooting, Adjustments, Ground testing.

Text Books:

1. Rolls Royce - "The Jet Engine" 5th edition, ISBN 0 902121 2 35, © Rolls-Royce plc 1986
2. Saravanamutto H.I.H, Rogers G.F.C., Cohen H, Gas Turbine Theory, 5th Edn., Pearson 2006

Reference Books:

1. Meherwan P. Boyce "Aircraft Propulsion and Gas Turbine Engines", CRC press, Taylor and Francis Group, London New York. ISBN 978-0-8493-9196-5
2. Meherwan P. Boyce "Gas Turbine Engineering Handbook (Fourth Edition)", 2012, Elsevier, ISBN-978-0-12-383842-1



B.E. (Mechanical Engineering) Curriculum structure & Syllabus 2018 – 22 Batch

Curriculum Content

Course Code:19EMEE401

Course Title: Dynamics & Durability of Vehicles

L-T-P: 3-0-0

Credits: 3

Contact Hrs: 3 hrs/week

ISA Marks: 80

ESA Marks: 20

Total Marks: 100

Teaching Hrs: 40

Exam Duration: 3 hrs

**PART A
 (Dynamics of Vehicles)**

Sl. No.	Content	Teaching Hours
1	Introduction - Kinematics & Compliance in vehicles;	02
2	Introduction to Roads and Loads;	02
3	Introduction to Durability in industry;	02
4	Data and Assumptions for multi-body systems - quality control;	03
5	Loads mapping for downstream use with examples;	03
6	Example applications using Multi-Body Dynamic Systems;	03
7	Introduction - Flex Body;	02
8	Durability example with and without Flex body;	03
9	Control systems in Multi-Body;	04
Total-Theory		24
Hands on Session		
01	Build a 2/3 wheeler suspension system to carry out K&C	08
02	Build a 3 wheeler suspension system to carry out loads extraction for durability	08
Total-Hands-on		16
TOTAL		40

**PART B
 (Durability of Vehicles)**

Sl. No.	Content	Teaching Hours
1	Conduction, Convection, Steady state, Transient flows, Turbulence and its significance	02
2	Importance of BTMS, Current state of thermal management in EV	02
3	Types of battery packs for xEV	02
4	Heat load calculation for battery packs	02
5	How to approach design assessment of power pack for thermal management	02
6	Importance of data & assumptions (includes baselining)	02
7	Example case of using AcuSolve to assess a design	03
8	How to improve the thermal performance of a power pack design	02
9	Importance of Drag co-eff for vehicles moving at high speeds	02
10	Fast assessment of A-Surface design for drag using VWT	02
11	Introduction to thermal management in electronic circuits	03
Total-Theory		24
Hands on Session		
01	Assume 2 different designs and compare the thermal performance	07
02	Prepare 2 vehicle designs (external surface) and compute drag	07
Total-Hands-on		16
TOTAL		36



B.E. (Mechanical Engineering) Curriculum structure & Syllabus 2018 – 22 Batch

Text Books/Reference Books:

1. Dr. N.K. Giri, Automotive Mechanics, 8th Edition, 2008, Khanna Publication, New Delhi.
2. Nitin Ghokale, Practical finite element analysis, Finite to infinite, 2008.
3. Practical Aspects of Structural Optimization, Altair University, 3rd Edition.
4. Robin Hardy, Iqbal Husain, "Electric and Hybrid Vehicles". CRC Press, ISBN 0-8493-1466-6.
5. Ron Hodkinson and John Fenton, "Lightweight Electric/ Hybrid Vehicle Design". SAE International
6. John M. Miller, Propulsion Systems for Hybrid Vehicles" Institute of Electrical Engineers, London, ISBN0 863413366.
7. Automobile Electrical and Electronic systems, Tom Denton, Third Edition, 2004, SAE International, SAE ISBN 0 7680 147 2, Society of Automotive Engineers. Inc 400 common wealth Drive, Warrendale, PA 15096-0001 USA.

PROJECTS:

Part A

Objective: To carry out Dynamic and Durability of different chassis

Sl. No.	Content
01	Compare durability of conventional ICE chassis with Electric version

Part B

Objective: To carry out to analyze the heat produced during EV operation and streamline external airflow

Sl. No.	Content
01	Compute Delta T for a chosen EV battery pack
02	Improve drag performance of a chosen external vehicle element



B.E. (Mechanical Engineering) Curriculum structure & Syllabus 2018 – 22 Batch

Curriculum Content

Course Code: 20EMEW401

L-T-P: 0-0-6

ISA Marks: 50

Credits: 6

ESA Marks: 50

Course Title: Senior Design Project

Total Marks: 100

Exam Duration: 3 hrs

About The Course:

Senior Design project course uses User experience design (UX) approach to solve complex engineering problems. In this course students are challenged to solve frontier complex engineering problems in the field of smart manufacturing, green engineering, Design engineering and advanced materials. The objective of the course is to infuse life long qualities in students such as research, design thinking, innovation and entrepreneurial qualities. After this course students are capable to convert customer pain points into business solution.



B.E. (Mechanical Engineering) Curriculum structure & Syllabus 2018 – 22 Batch

VIII Sem Bachelor of Engineering (Mechanical Engineering)

Curriculum Content

Course Code: 15EMEE413

Course Title: Aircraft Systems and Design

L-T-P: 3-0-0

Credits: 3

Contact Hrs: 3 hrs/week

ISA Marks: 50

ESA Marks: 50

Total Marks: 100

Teaching Hrs: 40

Exam Duration: 3 hrs

Unit I

1. Aircraft industry overview

3 Hrs

Evolution and History of Flight, Types Of Aerospace Industry, Key Players in Aerospace Industry, Aerospace Manufacturing, Airline deregulation, Structure of the industry, Airline economics, Aircraft design process, Aerospace Industry Trends.

2. Introduction to Aircrafts

5 Hrs

Basic components of an Aircraft, Structural members, Aircraft Axis System, Aircraft Motions, Control surfaces and High lift Devices. Types of Aircrafts - Lighter than Air/Heavier than Air Aircrafts Conventional Design Configurations based on Power Plant Location, Wing vertical location, intake location, Tail Unit Arrangements, Landing Gear Arrangements. Unconventional Configurations-Biplane, Variable Sweep, Canard Layout, Twin Boom Layouts, Span loaders, Blended Body Wing Layout, STOL and STOVL Aircraft, Stealth Aircraft. Advantages and disadvantages of these Configurations.

3. Introduction to Aircraft Mechanical Systems

8 Hrs

Types of Aircraft Systems, Mechanical Systems: Environmental control systems (ECS), Pneumatic systems, Hydraulic systems, Fuel systems, Landing gear systems, Engine Control Systems, Ice and rain protection systems, Cabin Pressurization and Air Conditioning Systems, Steering and Brakes Systems Auxiliary Power Unit.

Unit II

4. Basic Principles of Flight

6 Hrs

Significance of speed of Sound, Air speed and Ground Speed, Properties of Atmosphere, Bernoulli's Equation, Forces on the airplane, Airflow over wing section, Pressure Distribution over a wing section, Generation of Lift, Drag, Pitching moments, Types of Drag, Lift curve, Drag Curve, Lift/Drag Ratio Curve, Factors affecting Lift and Drag, Center of Pressure and its effects. Aero foil Nomenclature, Types of Aero foil, Wing Section-Aerodynamic Center, Aspect Ratio, Effects of lift, Drag, speed, Air density on drag,

5. Overview of the Aircraft Design Process

7 Hrs

Introduction, Phases of aircraft Design, Aircraft conceptual Design Process, Conceptual stage, Preliminary Design, Detailed Design, Design Methodologies. Aerodynamic loads, Inertial loads, Loads due to engine, Actuator loads, maneuver loads, VN diagrams, Gust loads, Ground loads, Ground conditions, Miscellaneous loads. Sample problems.

6. Aircraft materials

3 Hrs

Introduction, Basic construction, material forms- Metallic materials and forms. Alloy designations, Mechanical properties- strength, static, stress strain curves, fatigue properties, crack growth.



B.E. (Mechanical Engineering) Curriculum structure & Syllabus 2018 – 22 Batch

Unit III

7. Analysis of plates

4 Hrs

Theory of plates- Analysis of plates for bending, stresses due to bending, plate deflection under different conditions, Plate buckling, Compression buckling, shear buckling and buckling due to in plane bending moments. Sample exercises.

8. Analysis of Beams

4 Hrs

Theory of beams- Symmetric beams in pure bending, deflection of beams, Unsymmetrical beams in bending. Sample exercises. Torsion in closed section beams, torsion in open section beams, multi cell sections. Sample exercises.

Text Books:

1. Daniel P Raymer, "Aircraft Design- A conceptual Approach", 6, AIAA education series, 2012
2. T.H.G.Megson, "Aircraft Structures for Engineering Students", 5, Elsevier science publications, 2012.



B.E. (Mechanical Engineering) Curriculum structure & Syllabus 2018 – 22 Batch

Curriculum Content

Course Code: 15EMEE414

Course Title: Industrial Engineering Methods and Practices

L-T-P: 3-0-0

Credits: 3

Contact Hrs: 3 hrs/week

ISA Marks: 50

ESA Marks: 50

Total Marks: 100

Teaching Hrs: 40

Exam Duration: 3 hrs

Unit I

1. Industrial engineering and productivity

6 Hrs

Evolution of industrial engineering, industrial engineering functions, recent advances in industrial engineering, productivity of materials, land, buildings, machines and manpower, measurement of productivity, factors affecting the productivity.

2. Methods engineering:

4 Hrs

Objective and scope of work-study and method-study, human factor in work-study, work-study and management, work-study and supervisor, work-study and worker.

3. Methods analysis techniques:

6 Hrs

Types of recording techniques, process chart symbols, construction of charts (operation process chart, flow process chart, two hand process chart, multiple activity chart, travel chart, string diagram etc.), applications of various charts with examples.

Unit II

4. Micro motion study:

5 Hrs

Purpose of micro motion study, fundamental hand motions, therbligs, micro motion study equipments, cycle graph and chronocyclegraph, simo-chart construction, memo motion study.

5. Work measurement & time Study practice:

6 Hrs

Concept of human work, terminology used in work measurement, theory of work measurement, work measurement techniques, definition of time study, time study equipments, basic time study procedure, conducting the time study

6. Performance rating & computing standard time:

5 Hrs

Necessity of performance rating, factors influencing rating, rating systems and their details, allowances and their details, problems in time study and time standards, standard time computation with examples.

Unit III

7. Ergonomics:

4 Hrs

Areas of study under ergonomics, system approach to ergonomics model, man-machine system, work capabilities of industrial worker, general principles for carrying out physical activities.

8. Design of man-machine system interface:

4 Hrs

Concept of fatigue in industrial worker, relationship between controls and displays, design of work place and effect of environment (influence of climate on human efficiency, influence of noise, vibrations and lighting system).

Text Books:

1. Jhamb L. C, Work Study & Ergonomics, 16th Edition Everest Publishing House 2009

Reference Books:

1. ILO, Introduction to Work Study, 4th Revised Edition International Labour Office 1992
2. Suresh Dalela and Sourabh,, Work Study and Ergonomics, 6th edition Standard



Experience Engineering @

**School of Mechanical
Engineering KLETECH**

Engage | Explore | Excel | Evolve



B.E. (Mechanical Engineering) Curriculum structure & Syllabus 2018 – 22 Batch

Publishers Distributors 2017

3. Vijay Sheth, Industrial Engineering Methods and Practices, 5th Edition 2012 Penram International Publishing (India) Pvt.Ltd.



B.E. (Mechanical Engineering) Curriculum structure & Syllabus 2018 – 22 Batch

Curriculum Content

Course Code: 15EMEE415

Course Title: Advanced Energy Technology

L-T-P: 3-0-0

Credits: 3

Contact Hrs: 3 hrs/week

ISA Marks: 50

ESA Marks: 50

Total Marks: 100

Teaching Hrs: 40

Exam Duration: 3 hrs

Unit - I

1. Solar Radiation, Measurement of Solar Radiation, Solar Radiation Geometry

8 Hrs

Energy source, India's production and reserves of commercial energy sources, need for non-conventional energy sources. Solar Radiation : Extra-Terrestrial radiation, spectral distribution of extra terrestrial radiation, solar constant, solar radiation at the earth's surface, beam, diffuse and global radiation, solar radiation data. Measurement of Solar Radiation : Pyrometer, shading ring pyrheliometer, sunshine recorder, schematic diagrams and principle of working. Solar Radiation Geometry : Flux on a plane surface, latitude, declination angle, surface azimuth angle, hour angle, zenith angle, solar altitude angle expression for the angle between the incident beam and the normal to a plane surface (No derivation) local apparent time. Apparent motion of sun, day length, numerical examples.

2. Radiation Flux on a Tilted Surface, Solar Thermal Conversion

8 Hrs

Radiation Flux on a Tilted Surface : Beam, diffuse and reflected radiation, expression for flux on a tilted surface (no derivations) numerical examples. Solar Thermal Conversion : Collection and storage, thermal collection devices, liquid flat plate collectors, solar air heaters concentrating collectors (cylindrical, parabolic, paraboloid) (Quantitative analysis); sensible heat storage, latent heat storage, application of solar energy water heating. Space heating and cooling, active and passive systems, power generation, refrigeration. Distillation (Qualitative analysis) solar pond, principle of working, operational problems.

Unit – II

3. Solar Photovoltaic Energy Conversion and PV System Applications

8 Hrs

Principles - Physics and operation of solar cells. Classification of solar PV systems, Solar cell energy conversion efficiency, I-V characteristics, effect of variation of solar insolation and temperature, losses. Solar PV power plants. Building-integrated photovoltaic units, grid-interacting central power stations, standalone devices for distributed power supply in remote and rural areas, solar cars, aircraft, space solar power satellites. Socio-economic and environmental merits of photovoltaic systems.

4. Fuel Cell Technology

8 Hrs

Fuel cell electrochemistry - Reaction rate - Butler Volmer equation-implications and use of fuel cell polarization curve - Conversion of chemical energy in electricity in a fuel cell. Cogeneration - Fuel cell electric vehicles - Fuel cell vehicles - Motor cycles and bicycles-airplanes - Fueling stations - Fuel cell power plant structure - Fuel processor and fuel cell



B.E. (Mechanical Engineering) Curriculum structure & Syllabus 2018 – 22 Batch

stack. Advantages and disadvantages. Problems with fuel cells. Research related to fuel cell development in the world and in India.

Unit - III

5. Energy Storage

4 Hrs

Introduction, energy demand, energy storage devices, types of battery, basic principle, components, cathode and anode materials, effect of nano-size on energy storage and electrode materials performance, electrochemical energy storage, super-capacitors, advantage of nanotechnology in energy storage devices.

6. Energy Policy

4 Hrs

Energy policy issues - Fossil Fuels, renewable energy, power sector reforms, restructuring of energy supply sector, energy strategy for future. Energy conservation act and National electricity policy and plan.

Reference Books:

1. David Merick, Richard Marshall, (2001), Energy, Present and Future Options, Vol. I and II, John Wiley and sons.
2. Twidell, J.W. and Weir, A., Renewable Energy Sources, EFN Spon Ltd., 1986
3. Peter Gevorkian, Sustainable Energy Systems Engineering, McGraw Hill, 2007
4. Bagotsky .V.S, "Fuel Cells", Wiley, 2009.
5. Ibrahim Dincer and Marc A. Rosen, "Thermal Energy Storage Systems and Applications", 2nd Edition, John Wiley and Sons Ltd., 2011.



B.E. (Mechanical Engineering) Curriculum structure & Syllabus 2018 – 22 Batch

Curriculum Content

Course Code: 15EMEE416	Course Title: Thermal Management of Electronic Equipment	
L-T-P: 3-0-0	Credits: 3	Contact Hrs: 3 hrs/week
ISA Marks: 50	ESA Marks: 50	Total Marks: 100
Teaching Hrs: 40		Exam Duration: 3 hrs

Unit - I

- | | |
|---|-------|
| 1. Introduction | 5 Hrs |
| Semiconductor Technology Trends, Temperature-Dependent Failures, Importance of Heat Transfer in Electronics, Thermal Design Process, Energy and Work, Macroscopic and Microscopic Energies, Energy Transfer and Heat Transfer, Equation of State. | |
| 2. Thermal Resistance Network | 5 Hrs |
| Thermal Resistance Concept, Series Thermal Layers, Parallel Thermal Layers, General Resistance Network, Thermal Contact Resistance, Thermal Interface Materials, Spreading Thermal Resistance, Thermal Resistance of Printed Circuit Boards (PCBs). | |
| 3. Thermal Specification of Microelectronic Packages | 5 Hrs |
| Importance of Packaging, Packaging Types, Thermal Specifications of Microelectronic Packages, Package Thermal Resistance Network, Parameters Affecting Thermal Characteristics of a Package. | |

Unit – II

- | | |
|---|--------|
| 4. Cooling methods | 10 Hrs |
| Conduction Cooling, Convection Cooling, Selection Of Fan, Liquid Immersion Cooling, Flow-Through Cooling Of CCAs, Cold wall Cooling, Cold Plates, Jet Impingement Cooling, Synthetic Jet Cooling, Thermoelectric Or Solid State Coolers, Cooling Using Phase Change– Cooling With PCM Materials, Micro/Mini Channel Cooling, Cooling Using Heat Pipes– Working Principle, Selection Of Heat Pipe Working Fluid; Selection Of Cooling Technique– Ranges Of Cooling Rates Of Different Cooling Methods, Selection Criteria. | |
| 5. Fins and Heat Sinks | 5 Hrs |
| Fin Equation, Fin Thermal Resistance, Effectiveness, and Efficiency, Fins with Variable Cross Sections, Heat Sink Thermal Resistance, Effectiveness, and Efficiency, Heat Sink Manufacturing Processes. | |

Unit - III

- | | |
|--|-------|
| 6. Experimental Techniques and Thermal Design | 5 Hrs |
| Flow Rate Measurement Techniques, System Impedance Measurement, Fan and Pump Curve Measurements, Velocity Measurement Methods, Temperature Measurement Techniques, Acoustic Noise Measurements, Importance of Experimental Measurements in Thermal Design. | |
| 7. Computer Simulations and Thermal Design | 5 Hrs |
| Heat Transfer and Fluid Flow Equations: A Summary, Fundamentals of Computer Simulation, Turbulent Flows, Solution of Finite-Difference Equations
Commercial Thermal Simulation Tools, Importance of Modeling and Simulation in Thermal Design. | |



B.E. (Mechanical Engineering) Curriculum structure & Syllabus 2018 – 22 Batch

Text Books:

1. Younes Shabany, Heat Transfer: Thermal Management of Electronics, CRC Press Inc, 2010.
2. Ravi Kandasamy and Arun S. Mujumdar, Thermal Management of Electronic Components, Lambert Academic Publishing, 2010.

Reference Books:

1. Dave S. Steinberg, Cooling Techniques for Electronic Equipment, Wiley, 1991.
2. Sung Jin Kim, Sang Woo Lee, Air Cooling Technology for Electronic Equipment, Taylor & Francis, 1996.
3. Rao R. Tummala, Fundamentals of Microsystems Packaging, McGraw-Hill, 2001.
4. Yunus A. Cengel, Heat Transfer: A Practical Approach. McGraw-Hill, 2003.

B.E. (Mechanical Engineering) Curriculum structure & Syllabus 2018 – 22 Batch

Curriculum Content

Course Code: 15EMEO401

Course Title: Introduction to Nanoscience and Nanotechnology

L-T-P: 3-0-0

Credits: 3

Contact Hrs: 3 hrs/week

ISA Marks: 50

ESA Marks: 50

Total Marks: 100

Teaching Hrs: 40

Exam Duration: 3 hrs

Unit - I

1 Introduction:

5 Hrs

Nanotechnology, Frontier of future- an overview

Length scales, Variation of physical properties from bulk to thin films to nanomaterials, -confinement of electron energy states (LDOS) in 0D, 1D, 2D and 3D systems (qualitative treatment) ; Surface, size, shape and assembly effects.

Bonding and crystal structure in solids, colloids and core-shell structures. Chemical and molecular interaction, functionalization, basis for biological self-assembly and self-organization.

2 Synthesis of nanomaterials:

6 Hrs

Top-down approach: Lithography and soft processes, Ball milling, chemical stamping.

Bottom-Up approach: Chemical Routes for Synthesis of Nanomaterials, Solvo-thermal and Sol-gel synthesis; Microemulsions, micelles and reverse micelles; Physical and Chemical Vapour Deposition, Sputtering, Laser ablation, Epitaxy.

Biological Methods: Role of plants and bacteria in metal (magnetic and non-magnetic) nanoparticle synthesis

3 Characterization:

5 Hrs

Electron Microscopy (SEM/TEM); Scanning Probes (STM, AFM), X-ray Photoelectron Spectroscopy (XPS), Optical Spectroscopy –IR/UV/VIS, Raman, Photoluminescence, X-ray Diffraction (including Debye-Scherrer method), Particle Size Analyser-light Scattering, Electrical (I-V and C-V), Porosity (BET method), Zeta potential, nano-indentation.

Unit – II

4 Properties:

6 Hrs

- Electronic and optoelectronic properties: Ballistic transport, Coulomb blockade, Diffusive transport,
- Dielectric properties: Polarisation, Ferroelectric behavior.
- Optical Properties: Photoconductivity, Optical absorption & transmission, Plasmons and Excitons, Luminescence and Phosphorescence.
- Magnetic properties: Nanomagnetism, magneto-resistance; Super Para Magnetism
- Thermal and Mechanical properties: changes in thermal transport, thermal transition temperatures, and interfaces with dissimilar materials. Improved hardness and toughness of metals and alloys

Biological: Permeability through biological barriers, molecular recognition and biological assemblies.



B.E. (Mechanical Engineering) Curriculum structure & Syllabus 2018 – 22 Batch

5 General Applications:

5 Hrs

- Electrical, Electronics & Photonics- Switching glasses, Semiconductor devices including LEDs and Solar Cells, Photonic Crystals.
- Computer Science- Storage devices and Quantum computing etc
- Mechanical and Civil: Composites and their properties.
- Environmental and Chemical: Porous materials, Catalysis, tracers etc
- Biotechnology- Interaction between bimolecular and nanoparticle surface, nano-bio assemblies, Nanosensors etc

Unit - III

6 Specific Applications:

13 Hrs

Part of this can be implemented as a student project that involves: literature-survey, project report and a Seminar (Power-Point) Presentations by groups of two students each (applications and students to be identified by teachers and monitored by one teacher each):

- Carbon and its allotropes: Fullerenes (C_{60}), Carbon nanotubes and Graphene:
- Applications of Carbon Nanotubes: Field emission, Fuel Cells, Display devices, Hydrogen storage.
- Nano-Medicine: Developments and protocols for diagnostics, drug delivery and therapeutics.
- Nanotribology: Friction at nanoscale, Nanotribology and wear-resistance, MEMS and NEMS
- Photo-electronics: Merger of photonics and electronics at nanoscale dimensions
- Single electron devices, molecular circuits
- Nanocomposites (i.e. metal oxide, ceramic, glass and polymer and core-shellbased);
- Biomimetics and Biomaterials, synthetic nanocomposites for bone, teeth replacement, DNA scaffolding.
- Nanosensors: Temperature Sensors, Chemical and gas Sensors, Light and radiation sensors

7 Demonstration through experiments:

4 Hrs

1. Chemical synthesis of Au and Ag nanoparticles and characterization by Optical spectroscopy of size dependence band-gap
2. Debye Scherrer analysis of XRD data of nanoparticles of different sizes.
3. Surface area and Pore size distribution of the BET data from a nano-porous material.
4. Some experiment to study mechanical strength of nanocomposites (nano-indentation)

8 Guest lectures from industries and research laboratory personnel:

1 Hrs

Societal issues of Nanotechnology: Prospects and Dangers; Commercial aspects, emerging industry and employment opportunities.



B.E. (Mechanical Engineering) Curriculum structure & Syllabus 2018 – 22 Batch

Text Books:

References:

1. Nano Materials- A.K.Bandyopadhyay/ New Age Publishers.
2. Nanocrystals: Synthesis, Properties and Applications.
3. C. N. R. Rao, P. John Thomas and G. U. Kulkarni, Springer Series In Materials Science.
4. Nano Essentials- T.Pradeep/TMH.
5. Plenty of Room for Biology at the Bottom-An introduction to bio-nanotechnology, E. Guzit, Imperial College Press

Books Recommended for extra reading:

1. Introduction to Nanotechnology, C P Poole & F J Owens, Wiley, 2003.
2. Understanding Nanotechnology, Scientific American 2002.
3. Nanotechnology, M Ratner & D Ratner, Prentice Hall 2003.
4. Nanotechnology, M Wildon, K Kannagara G Smith, M Simmons & B Raguse, CRC Press Boca Raton 2002.

Apart from the above, in view of the course being of advanced nature, the content of course will be supplemented with course material from the course instructors.

B.E. (Mechanical Engineering) Curriculum structure & Syllabus 2018 – 22 Batch

Curriculum Content

Course Code: 15EMEO402

Course Title: Nanotechnology

L-T-P: 3-0-0

Credits: 3

Contact Hrs: 3 hrs/week

ISA Marks: 50

ESA Marks: 50

Total Marks: 100

Teaching Hrs: 40

Exam Duration: 3 hrs

Unit - I

1. An overview of Nanoscience & Nanotechnology: 4 Hrs

Historical background – nature, scope and content of the subject – multidisciplinary aspects – industrial, economic and societal implications

2. Experimental Techniques and Methods: 5 Hrs

For investigating and manipulating materials in the nano scale – electron microscope – scanning probe microscope – optical and other microscopes

3. Fullerenes: 6 Hrs

Discovery, synthesis and purification – chemistry of fullerenes in the condensed phase – orientational ordering – pressure effects – conductivity and superconductivity – ferromagnetism – optical properties.

Carbon Nanotubes – synthesis and purification – filling of nanotubes – mechanism of growth – electronic structure – transport properties – mechanical and physical properties – applications

Unit – II

4. Self-assembled Monolayers: 5 Hrs

Monolayers on gold – growth process – phase transitions – patterning monolayers – mixed monolayers – applications

5. Semiconductor Quantum Dots: 5 Hrs

Synthesis – electronic structure of nanocrystals – how quantum dots are studied – correlation of properties with size – uses

6. Monolayer-protected Metal Nanoparticles: 5 Hrs

Method of preparation – characterization – functionalized metal nanoparticles – applications – superlattices

Unit - III

7. Nanobiology: 5 Hrs

Interaction between biomolecules and nanoparticle surfaces – materials used for synthesis of hybrid nano-bio assemblies – biological applications – nanoprobe for analytical applications – nanobiotechnology – future perspectives



B.E. (Mechanical Engineering) Curriculum structure & Syllabus 2018 – 22 Batch

8. Molecular Nanomachines:

Covalent and non-covalent approaches – molecular motors and machines – other molecular devices – single molecular devices – practical problems involved

Text Books:

1. T Pradeep (Professor, IIT Madras); NANO: The Essentials – Understanding Nanoscience and Nanotechnology; Tata McGraw-Hill India (2007)

Reference Books:

1. Richard Booker & Earl Boysen; Nanotechnology: Wiley (2005).
2. Di Ventra, Introduction to Nanoscale Science and Technology [Series: Nanostructure Science and Technology]: et al (Ed); Springer (2004).
3. Demystified: Linda Williams & Wade Adams; Nanotechnology McGraw-Hill (2007)
4. Charles P Poole Jr, Frank J Owens, Introduction to Nanotechnology: Wiley India Pvt. Ltd., New Delhi, 2007



B.E. (Mechanical Engineering) Curriculum structure & Syllabus 2018 – 22 Batch

Curriculum Content

Course Code: 15EMEO403

Course Title: Design of Experiments

L-T-P: 3-0-0

Credits:3

Contact Hrs: 3 hrs/week

ISA Marks: 50

ESA Marks: 50

Total Marks: 100

Teaching Hrs: 40 hrs

Exam Duration: 3hrs

Unit I

Chapter 1. Introduction

04 Hrs

Strategy of experimentation, applications of experimental design, basic principles, guidelines for designing the experiments.

Chapter 2. Taguchi's approach to quality

04 Hrs

Definition of quality, Taguchi's quality philosophy, Quality loss function, off-line and on-line quality control, Signal and Noise Factors.

Chapter 3. Motivation for using ANOVA

08 Hrs

Introduction to analysis of variance (ANOVA), test of hypothesis, limitations of testing of hypothesis for difference between the means of two samples, testing of hypothesis using chi-square, t-test and F-test, one-way ANOVA examples.

Unit II

Chapter 4. Factorial Experiments

08 Hrs

Two-Factor Factorial Design, General Factorial Design, 2^2 , 2^3 and 2^4 Full Factorial Designs, Exercises

Chapter 5. Fractional Factorial Designs

04 Hrs

One half fraction of 2^k Design, One quarter fraction of 2^k Design, General 2^{k-p} Fractional Factorial Design, Exercises

Chapter 6. Regression Approach

04 Hrs

Simple Regression and Multiple regressions, Types of designs, Central composite design and Box-Behnken design, Exercises

Unit – III

Chapter 7. Orthogonal Array Experiments

04 Hrs

Introduction, Design of Orthogonal arrays, ANOVA for Orthogonal Array.

Chapter 8. Robust Parameter Design

04 Hrs

Introduction, Signal-to-Noise ratio, ANOVA for S/N ratio, Steps of S/N approach.

Text Books:

1. Douglas C. Montgomery, "Design and Analysis of Experiments", John Wiley and Sons.
2. Madhav S. Phadke, "Quality Engineering using Robust Design", Prentice Hall PTR, Englewood Cliffs, New Jersey.
3. R. Panneerselvam, "Design and Analysis of Experiments- R PHI Learning Private Limited, New Delhi.

Reference Books:

1. Robert H. Lochner and Joseph E. Matar, "Designing for Quality- an Introduction Best of Taguchi and Western Methods or Statistical Experimental Design", Chapman and Hall.
2. Philips .J. Ross, "Taguchi Techniques for Quality Engineering", McGraw Hill, New York.



B.E. (Mechanical Engineering) Curriculum structure & Syllabus 2018 – 22 Batch

Curriculum Content

Course Code: 15EMEO404

Course Title: Engine Management Systems

L-T-P: 3-0-0

Credits: 3

Contact Hrs: 3 hrs/week

ISA Marks: 50

ESA Marks: 50

Total Marks: 100

Teaching Hrs: 40

Exam Duration: 3 hrs

Unit - I

1 Basics of Gasoline (SI) Engine

6 Hrs

Introduction, Operating concept, Valve timing, Stages of combustion, Combustion knock, Effect of engine variables on knock, Torque and power, Engine efficiency, Specific fuel consumption, Fuels for spark ignition engines.

2 Gasoline engine management

4 Hrs

Technical requirement, Cylinder charge control, Air-charge control, Variable valve timing, controlled charge flow, A/F –mixture formation, Ignition- Battery ignition systems, Electronic ignition system, Inductive ignition system, Ignition coils, Spark plugs.

3 Gasoline fuel injection

5 Hrs

Fuel supply for manifold injection, Operating concept, Electromagnetic fuel injectors, Types of fuel injection, Fuel supply for gasoline direct injection, Operating concept, Rail, High pressure pump, Pressure control valve, High pressure injector, Combustion process, A/F mixture formation, Operating modes
Motronic engine management, ME-Motronic, MED-Motronic.

Unit – II

4 Basics of Diesel Engine

5 Hrs

Method of operation, Stages of combustion, Operating statuses, Fuel-injection system, Combustion chambers-Di and IDI, Diesel fuels-properties, Alternative fuels- Alcohols, Vegetable oils.
Cylinder Charge Control - Intake air filters, Swirl flaps, Superchargers & Turbochargers, Exhaust Gas Recirculation.

5 Diesel fuel injection

5 Hrs

Requirements of ideal fuel injection system, Basic Principles of fuel supply - Mixture distribution, Start of fuel injection and delivery, Injected fuel quantity, Injection characteristics, Injection pressure, Injection direction and number of injection jets. Fuel supply system.

6 Fuel injection pumps

5 Hrs

Design and method of operation of in-line fuel injection pump systems, Distributor fuel injection pump systems, Unit injector system and unit pump system, Common rail system. Nozzles and Nozzle holders - Pintle nozzles, Hole type nozzles, future development.



B.E. (Mechanical Engineering) Curriculum structure & Syllabus 2018 – 22 Batch

Unit - III

7 Engine Exhaust Emission Control

5 Hrs

Formation of NO_x, HC/CO mechanism, Smoke and Particulate emissions, Methods of controlling emissions- Thermal converter, Catalytic converter and Particulate Trap, Diesel Smoke and its control, Emission (HC, CO, NO and NO_x) measuring equipments, Emission norms.

8 Recent Trends in IC Engines

5 Hrs

Dual fuel Engine, Homogeneous Charge Compression Ignition Engine (HCCI), Reactivity controlled compression ignition engine (RCCI), Lean Burn Engine, VVT engines,

Text Books:

1. Robert Bosch GmbH, 2004, Gasoline Engine Management – 2nd Edition
2. Robert Bosch GmbH, 2004, Diesel Engine Management “ 3rd Edition

Reference Books:

1. Mathur and Sharma, Dhanpal Rai & sons, A Course in I.C.Engine –New Delhi
2. John B. Heywood, Internal Combustion Engine Fundamentals –McGraw- Hill